

Low Vcesat NPN Epitaxial Planar Transistor

BTC5706J3

Features

- Low collector-to-emitter saturation voltage
- High-speed switching
- High allowable power dissipation
- Large current capability

Applications

- DC-DC converter, relay drivers, lamp drivers, motor drivers, strobes.

Symbol

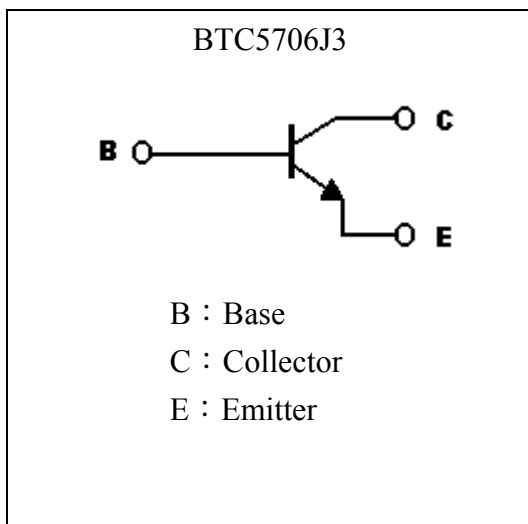

Outline

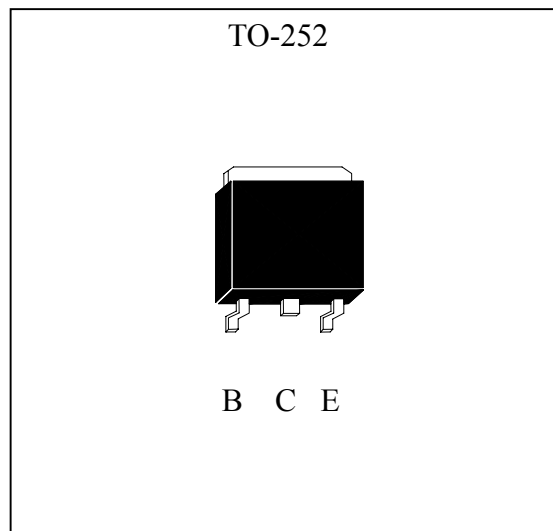



Absolute Maximum Ratings (Ta=25°C)

Parameter	Symbol	Limits	Unit
Collector-Base Voltage	V _{CBO}	80	V
Collector-Emitter Voltage	V _{CES}	80	V
Collector-Emitter Voltage	V _{CEO}	60	V
Emitter-Base Voltage	V _{EBO}	6	V
Collector Current (DC)	I _C	5	A
Collector Current (Pulse)	I _{CP}	7.5 (Note 1)	
Base Current	I _B	1.2	A
Power Dissipation @ T _A =25°C	P _D	0.8	W
Power Dissipation @ T _C =25°C	P _D	15	
Thermal Resistance, Junction to Ambient	R _{θJA}	156	°C/W
Thermal Resistance, Junction to Case	R _{θJC}	8.33	°C/W
Junction Temperature	T _j	150	°C
Storage Temperature	T _{stg}	-55~+150	°C

Note : 1. Single Pulse , P_w ≤ 380μs, Duty ≤ 2%.

Characteristics (Ta=25°C)

Symbol	Min.	Typ.	Max.	Unit	Test Conditions
BV _{CBO}	80	-	-	V	I _C =10μA, I _E =0
BV _{CES}	80	-	-	V	I _C =100μA, R _{BE} =0
*BV _{CEO}	60	-	-	V	I _C =1mA, I _B =0
BV _{EBO}	6	-	-	V	I _C =10μA, I _C =0
I _{CBO}	-	-	1	μA	V _{CB} =80V, I _E =0
I _{EBO}	-	-	1	μA	V _{EB} =4V, I _C =0
*V _{CE(sat) 1}	-	110	135	mV	I _C =1A, I _B =50mA
*V _{CE(sat) 2}	-	200	240	mV	I _C =2A, I _B =100mA
*V _{BE(sat)}	-	0.89	1.2	V	I _C =2A, I _B =100mA
*h _{FE}	200	-	560	-	V _{CE} =2V, I _C =500mA
f _T	-	400	-	MHz	V _{CE} =10V, I _C =500mA
C _{ob}	-	15	-	pF	V _{CB} =10V, f=1MHz
t _{on}	-	35	-	ns	V _{CC} =25V, I _C =10I _{B1} =-10I _{B2} =1A, R _L =25Ω
t _{stg}	-	300	-	ns	
t _f	-	20	-	ns	

*Pulse Test : Pulse Width ≤ 380μs, Duty Cycle ≤ 2%

Characteristic Curves

Current Gain vs Collector Current

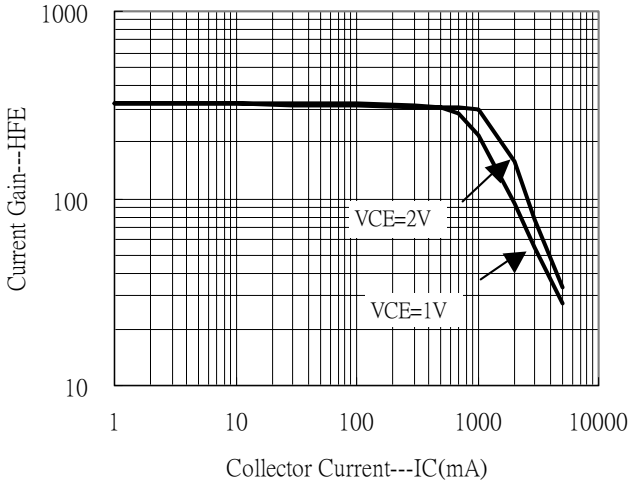

Saturation Voltage vs Collector Current

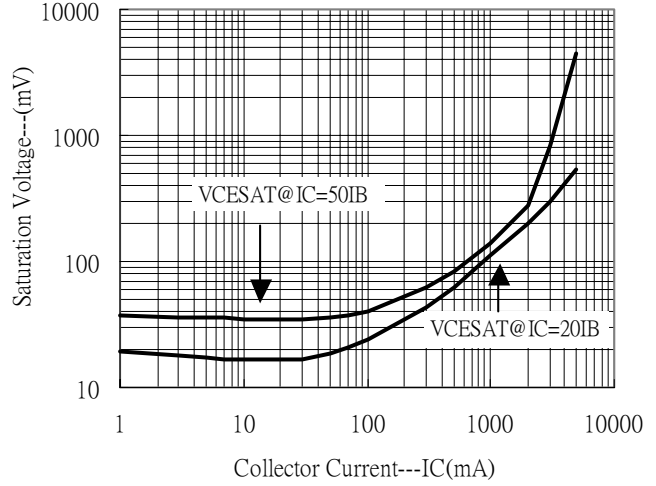

Saturation Voltage vs Collector Current

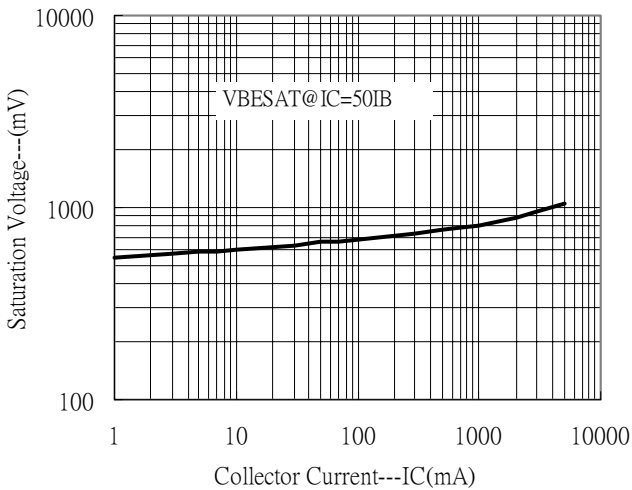

Output Characteristics

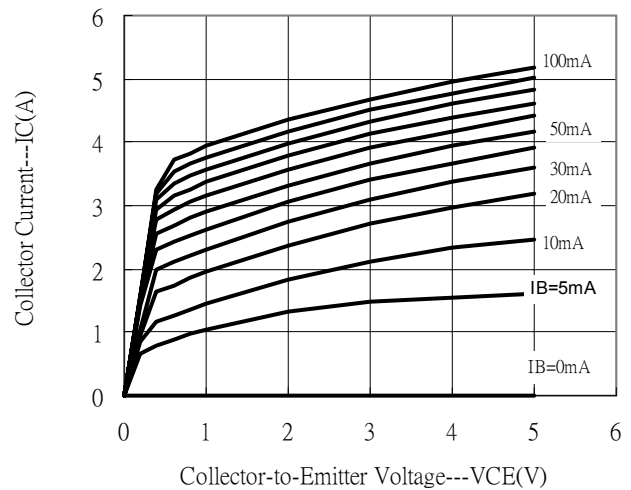

On Voltage vs Collector Current

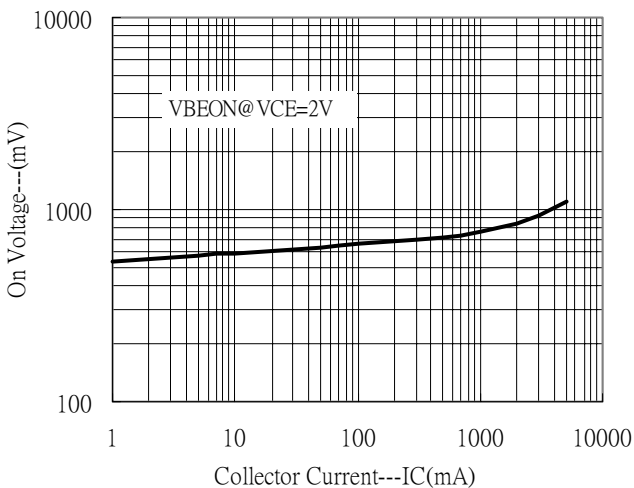

Power Derating Curve

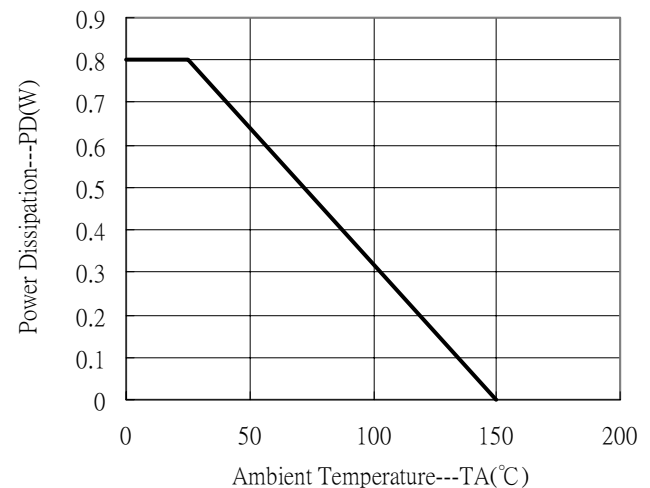



Characteristic Curves(Cont.)

Power Derating Curve

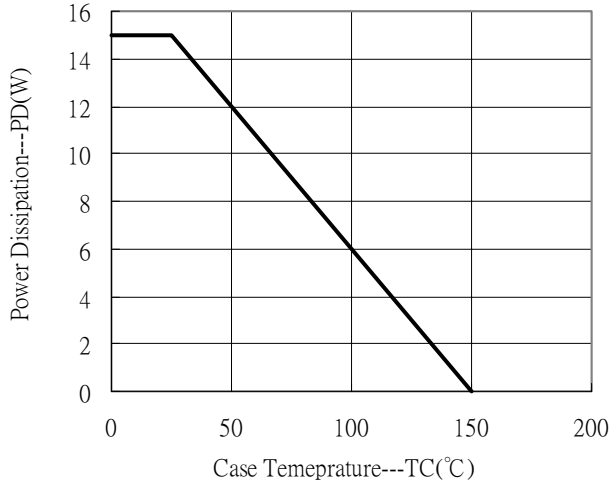

TO-252 Dimension

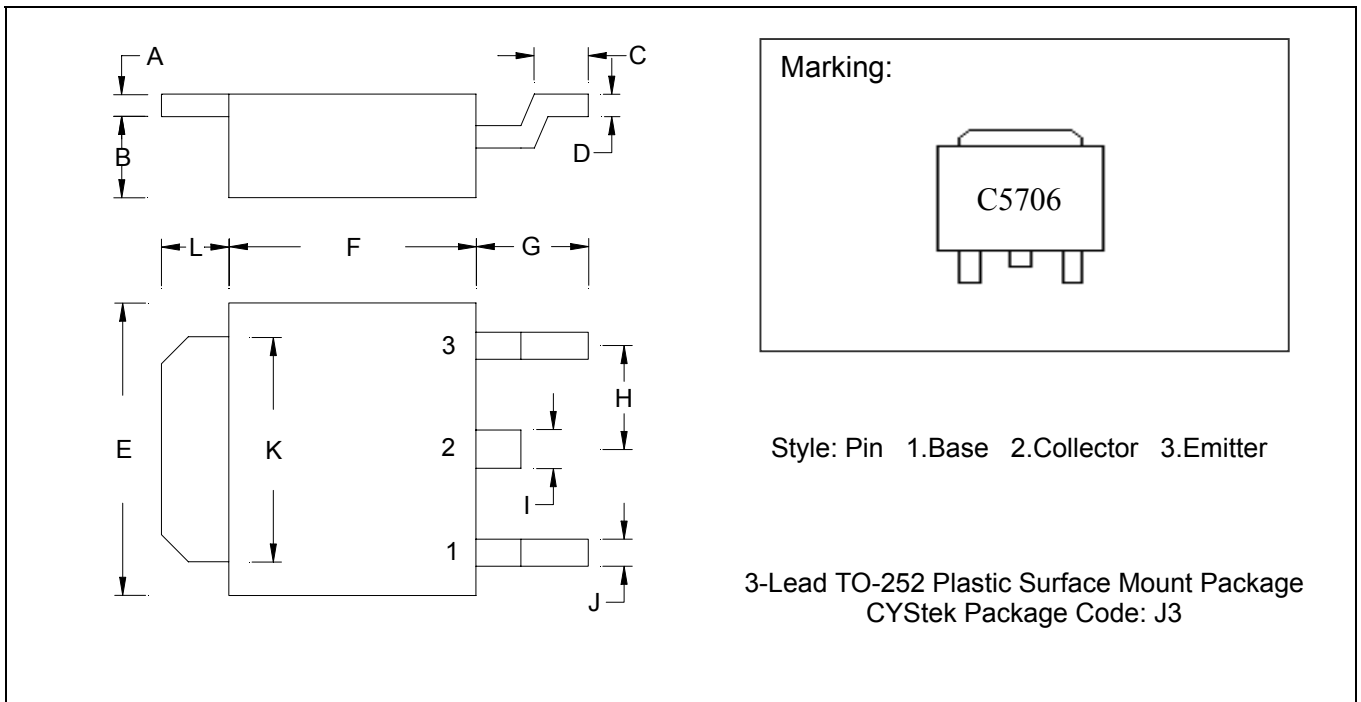

*: Typical

DIM	Inches		Millimeters		DIM	Inches		Millimeters	
	Min.	Max.	Min.	Max.		Min.	Max.	Min.	Max.
A	0.0177	0.0217	0.45	0.55	G	0.0866	0.1102	2.20	2.80
B	0.0650	0.0768	1.65	1.95	H	-	*0.0906	-	*2.30
C	0.0354	0.0591	0.90	1.50	I	-	0.0354	-	0.90
D	0.0177	0.0236	0.45	0.60	J	-	0.0315	-	0.80
E	0.2520	0.2677	6.40	6.80	K	0.2047	0.2165	5.20	5.50
F	0.2125	0.2283	5.40	5.80	L	0.0551	0.0630	1.40	1.60

Notes: 1.Controlling dimension: millimeters.
 2.Maximum lead thickness includes lead finish thickness, and minimum lead thickness is the minimum thickness of base material.
 3.If there is any question with packing specification or packing method, please contact your local CYStek sales office.

Material:

- Lead: 42 Alloy; solder plating
- Mold Compound: Epoxy resin family, flammability solid burning class: UL94V-0

Important Notice:

- All rights are reserved. Reproduction in whole or in part is prohibited without the prior written approval of CYStek.
- CYStek reserves the right to make changes to its products without notice.
- CYStek **semiconductor products are not warranted to be suitable for use in Life-Support Applications, or systems.**
- CYStek assumes no liability for any consequence of customer product design, infringement of patents, or application assistance.