

Low Vcesat NPN Epitaxial Planar Transistor

BTD1805D3

Description

The device is manufactured in NPN planar technology by using a “Base Island” layout. The resulting transistor shows exceptional high gain performance coupled with very low saturation voltage.

Features

- Very low collector-to-emitter saturation voltage
- Fast switching speed
- High current gain characteristic
- Large current capability
- Pb-free package

Applications

- CCFL drivers
- Voltage regulators
- Relay drivers
- High efficiency low voltage switching applications

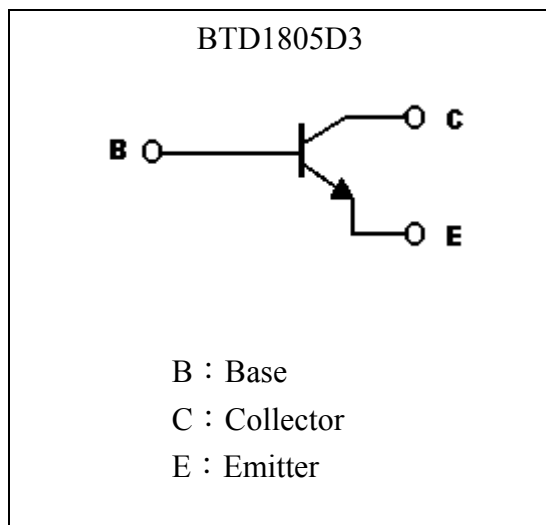
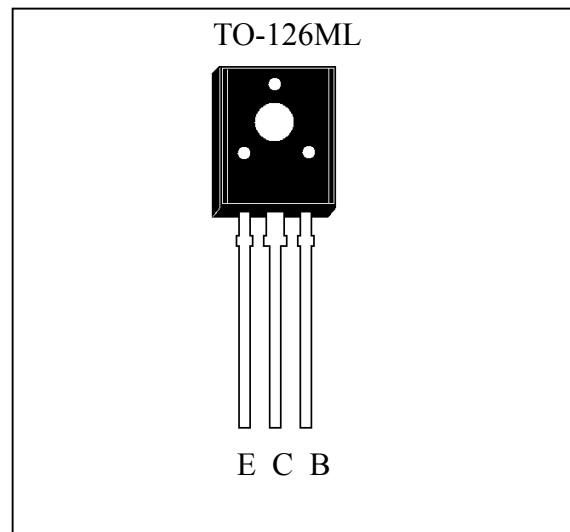
Symbol**Outline**



Absolute Maximum Ratings (Ta=25°C)

Parameter	Symbol	Limits	Unit
Collector-Base Voltage (IE=0)	V _{CBO}	150	V
Collector-Emitter Voltage (IB=0)	V _{CEO}	60	V
Emitter-Base Voltage (IC=0)	V _{EBO}	7	V
Collector Current (DC)	I _C	5	A
Collector Current (Pulse)	I _{CP}	10 (Note 1)	
Base Current	I _B	2	A
Power Dissipation @ TA=25°C	P _D	1	W
Power Dissipation @ TC=25°C	P _D	20	
Thermal Resistance, Junction to Ambient	R _{θJA}	125	°C/W
Thermal Resistance, Junction to Case	R _{θJC}	8.33	°C/W
Junction Temperature	T _j	150	°C
Storage Temperature	T _{stg}	-55~+150	°C

Note : 1. Single Pulse , Pw ≤ 380μs, Duty ≤ 2%.

Characteristics (Ta=25°C)

Symbol	Min.	Typ.	Max.	Unit	Test Conditions
BV _{CBO}	150	-	-	V	I _C =100μA, I _E =0
*BV _{CEO}	60	-	-	V	I _C =1mA, I _B =0
BV _{EBO}	7	-	-	V	I _C =100μA, I _C =0
I _{CBO}	-	-	0.1	μA	V _{CB} =80V, I _E =0
I _{EBO}	-	-	0.1	μA	V _{EB} =4V, I _C =0
*V _{CE(sat)} 1	-	-	50	mV	I _C =100mA, I _B =5mA
*V _{CE(sat)} 2	-	200	300	mV	I _C =2A, I _B =50mA
*V _{CE(sat)} 3	-	240	400	mV	I _C =3A, I _B =150mA
*V _{CE(sat)} 4	-	-	600	mV	I _C =5A, I _B =200mA
*V _{BE(sat)}	-	0.9	1.2	V	I _C =2A, I _B =100mA
*h _{FE} 1	200	-	400	-	V _{CE} =2V, I _C =100mA
*h _{FE} 2	85	-	-	-	V _{CE} =2V, I _C =5A
*h _{FE} 3	20	-	-	-	V _{CE} =2V, I _C =10A
f _T	-	150	-	MHz	V _{CE} =10V, I _C =50mA
C _{ob}	-	50	-	pF	V _{CB} =10V, f=1MHz
t _{on}	-	50	-	ns	V _{CC} =30V, I _C =10I _{B1} =-10I _{B2} =1A, R _L =30Ω
t _{stg}	-	1.35	-	μs	
t _f	-	120	-	ns	

*Pulse Test : Pulse Width ≤ 380μs, Duty Cycles ≤ 2%

Characteristic Curves

Current Gain vs Collector Current

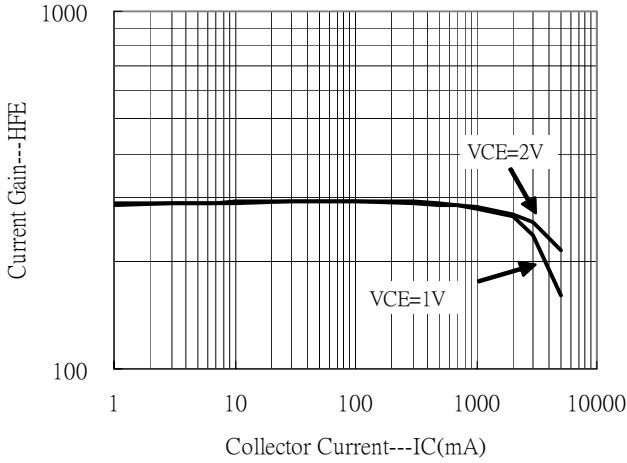

Saturation Voltage vs Collector Current

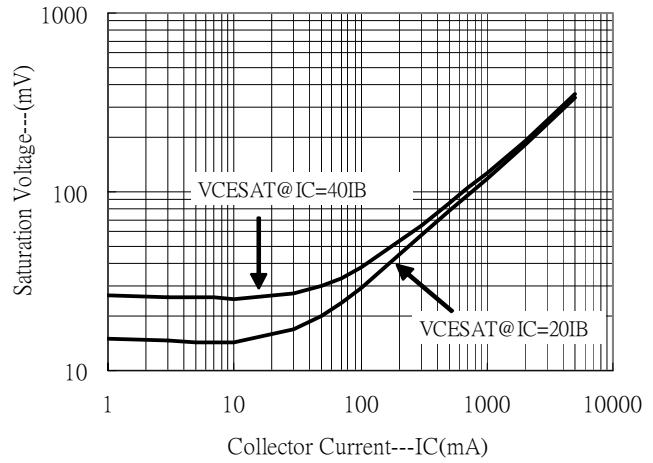

Saturation Voltage vs Collector Current

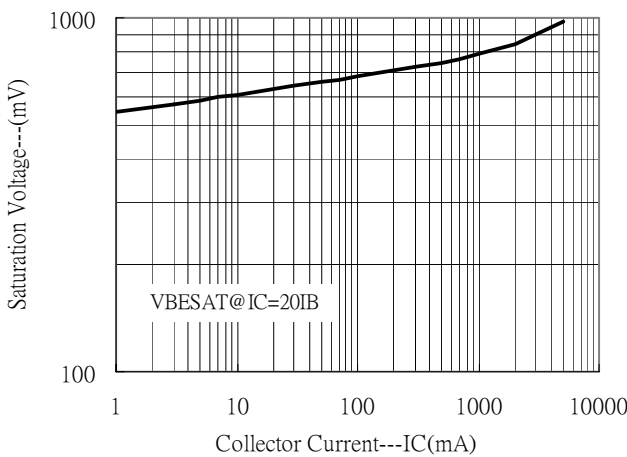

On Voltage vs Collector Current

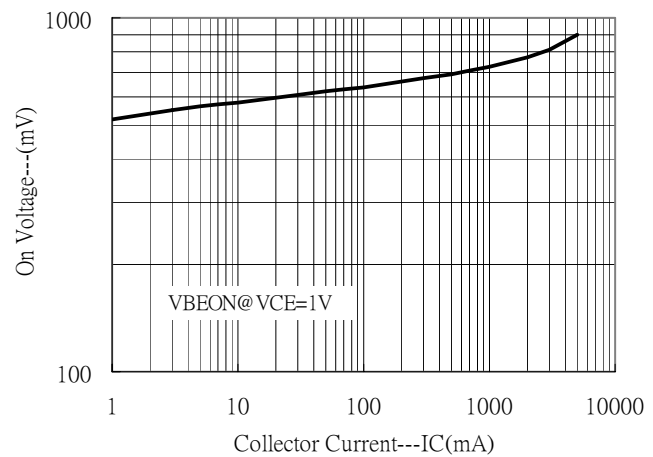

Power Derating Curve

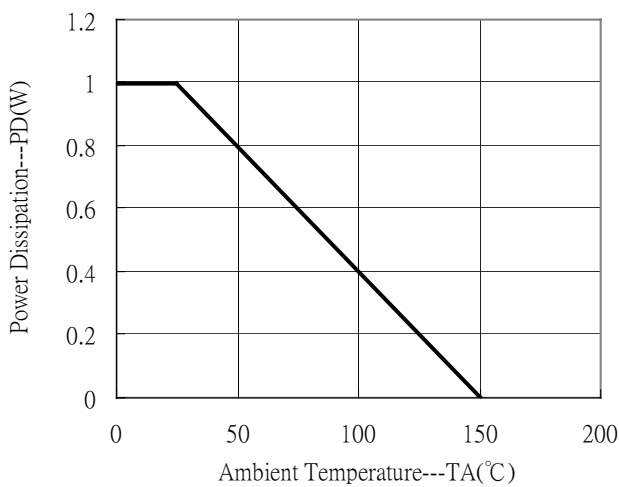

Power Derating Curve

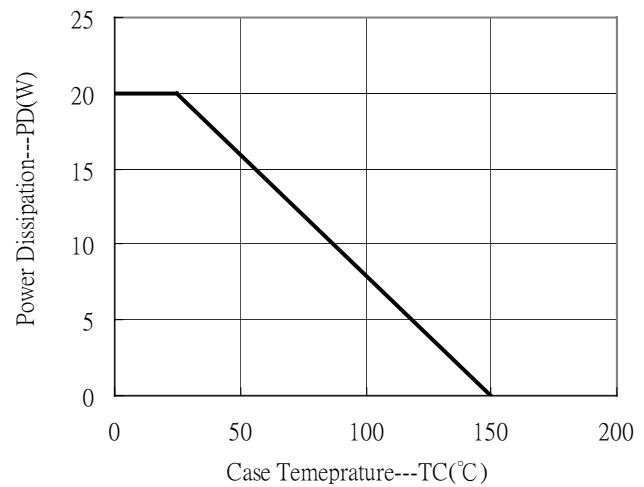

TO-126ML Dimension

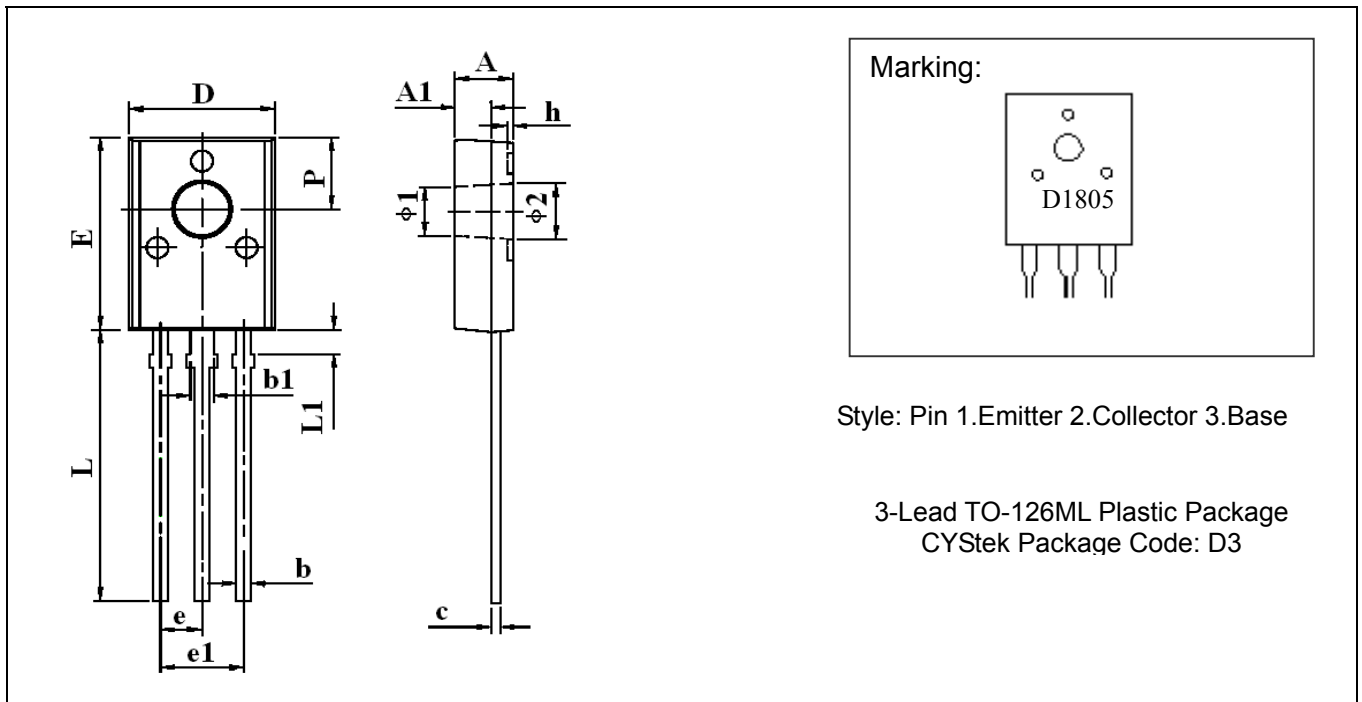

*: Typical

DIM	Inches		Millimeters		DIM	Inches		Millimeters	
	Min.	Max.	Min.	Max.		Min.	Max.	Min.	Max.
A	0.118	0.134	3.000	3.400	e	*0.090		*2.28	
A1	0.071	0.087	1.800	2.200	e1	0.176	0.183	4.460	4.660
b	0.026	0.034	0.660	0.860	L	0.594	0.610	15.100	15.500
b1	0.046	0.054	1.170	1.370	L1	0.051	0.059	1.300	1.500
c	0.018	0.024	0.450	0.600	P	0.159	0.167	4.040	4.240
D	0.307	0.323	7.800	8.200	Φ ₁	0.118	0.126	3.000	3.200
E	0.425	0.441	10.800	11.200	Φ ₂	0.122	0.130	3.100	3.300

Notes: 1. Controlling dimension: millimeters.
 2. Maximum lead thickness includes lead finish thickness, and minimum lead thickness is the minimum thickness of base material.
 3. If there is any question with packing specification or packing method, please contact your local CYStek sales office.

Material:

- Lead: 42 Alloy ; solder plating
- Mold Compound: Epoxy resin family, flammability solid burning class: UL94V-0

Important Notice:

- All rights are reserved. Reproduction in whole or in part is prohibited without the prior written approval of CYStek.
- CYStek reserves the right to make changes to its products without notice.
- CYStek **semiconductor products are not warranted to be suitable for use in Life-Support Applications, or systems.**
- CYStek assumes no liability for any consequence of customer product design, infringement of patents, or application assistance.