

Silicon NPN Epitaxial Planar Transistor
BTD1857AJ3

BV_{CEO}	160V
I_C	1.5A

Description

- High BV_{CEO}
- High current capability
- Complementary to BTB1236AJ3
- Pb-free lead plating and halogen-free package

Symbol

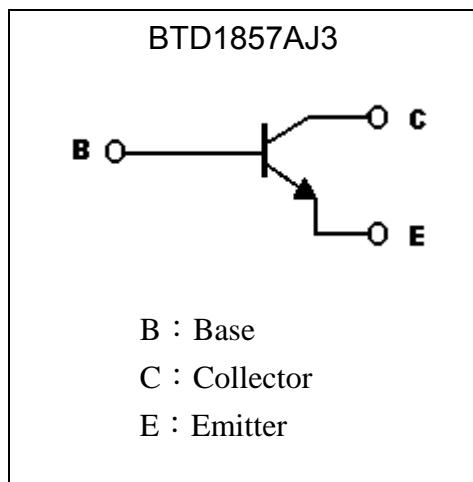

Outline

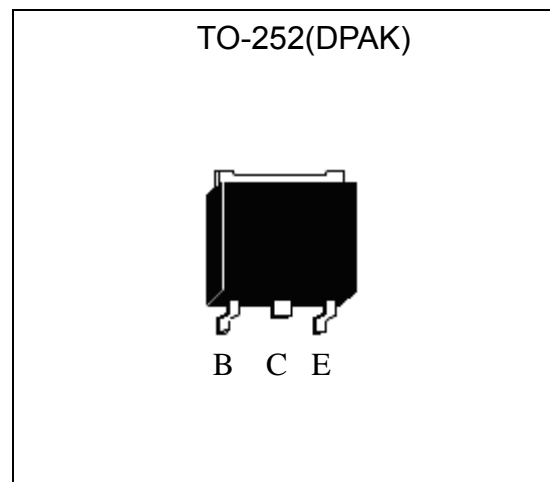

Ordering Information

Device	Package	Shipping
BTD1857AJ3-X-T3-G	TO-252 (Pb-free lead plating and halogen-free package)	2500 pcs / Tape & Reel

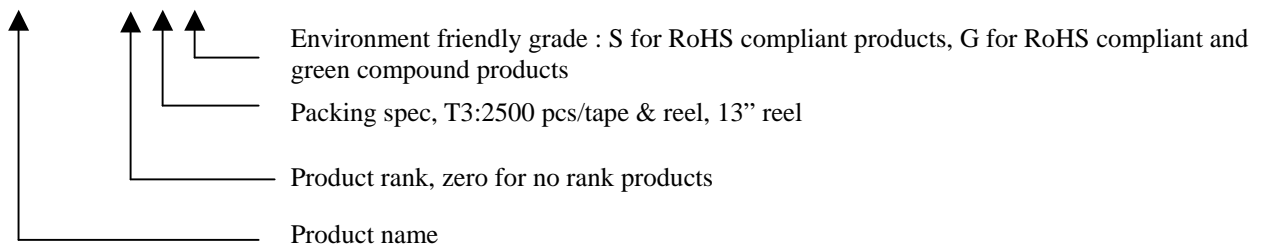

**Absolute Maximum Ratings** (Ta=25°C)

Parameter	Symbol	Limits	Unit
Collector-Base Voltage	V _{CB0}	180	V
Collector-Emitter Voltage	V _{CEO}	160	V
Emitter-Base Voltage	V _{EBO}	5	V
Collector Current (DC)	I _C	1.5	A
Collector Current (Pulse)	I _{CP}	3	A
Power Dissipation @T _A =25°C	P _D	1	W
Power Dissipation @T _C =25°C		10	W
Junction Temperature	T _j	150	°C
Storage Temperature	T _{stg}	-55~+150	°C

Thermal Data

Parameter	Symbol	Value	Unit
Thermal Resistance, Junction-to-case, max	R _{th,j-c}	12.5	°C/W
Thermal Resistance, Junction-to-ambient, max	R _{th,j-a}	125	°C/W

Characteristics (Ta=25°C)

Symbol	Min.	Typ.	Max.	Unit	Test Conditions
BV _{CB0}	180	-	-	V	I _C =50μA, I _E =0
BV _{CEO}	160	-	-	V	I _C =1mA, I _B =0
BV _{EBO}	5	-	-	V	I _E =50μA, I _C =0
I _{CB0}	-	-	1	μA	V _{CB} =160V, I _E =0
I _{EBO}	-	-	1	μA	V _{EB} =4V, I _C =0
*V _{CE(sat)}	-	-	0.6	V	I _C =1A, I _B =100mA
*V _{BE(on)}	-	-	1.5	V	V _{CE} =5V, I _C =150mA
h _{FE1}	180	-	390	-	V _{CE} =5V, I _C =150mA
h _{FE2}	30	-	-	-	V _{CE} =5V, I _C =500mA
f _T	-	140	-	MHz	V _{CE} =5V, I _C =150mA
C _{ob}	-	27	-	pF	V _{CB} =10V, I _E =0, f=1MHz

*Pulse Test: Pulse Width ≤380μs, Duty Cycle≤2%

Classification Of h_{FE} 1

Rank	R
Range	180~390

Typical Characteristics

Current Gain vs Collector Current

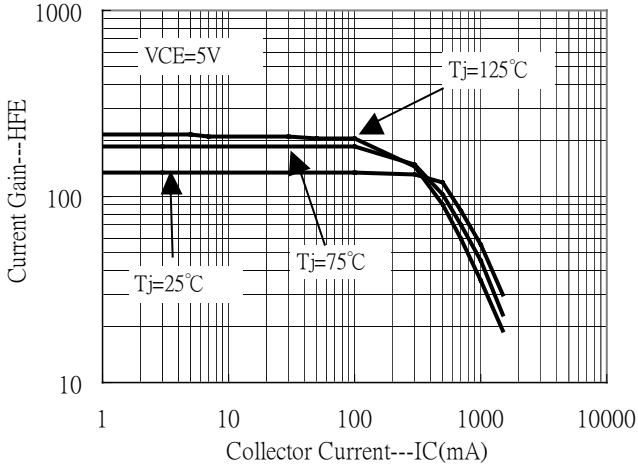

Saturation Voltage vs Collector Current

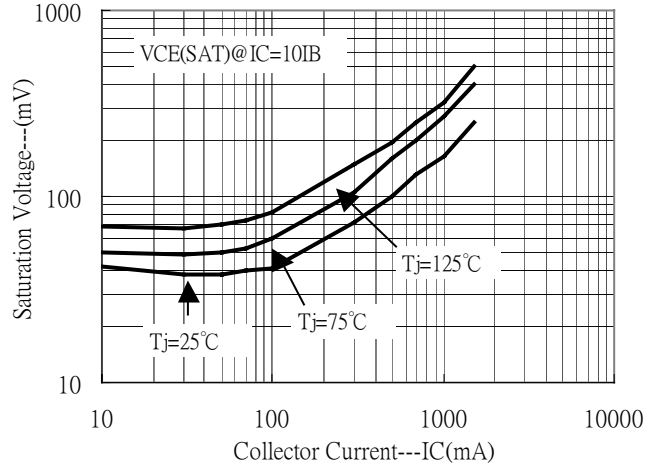

Saturation Voltage vs Collector Current

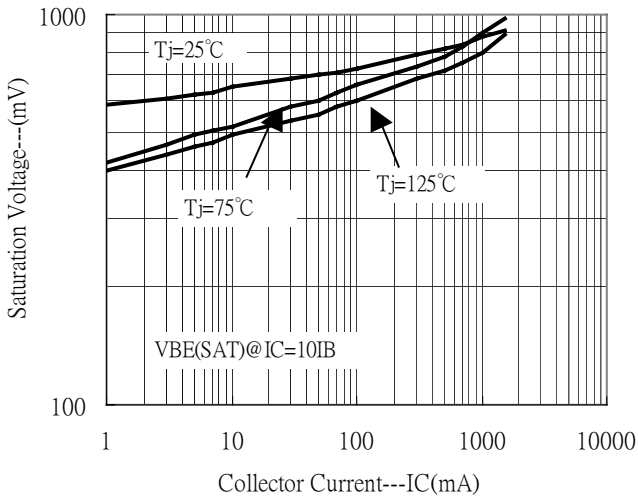

On Voltage vs Collector Current

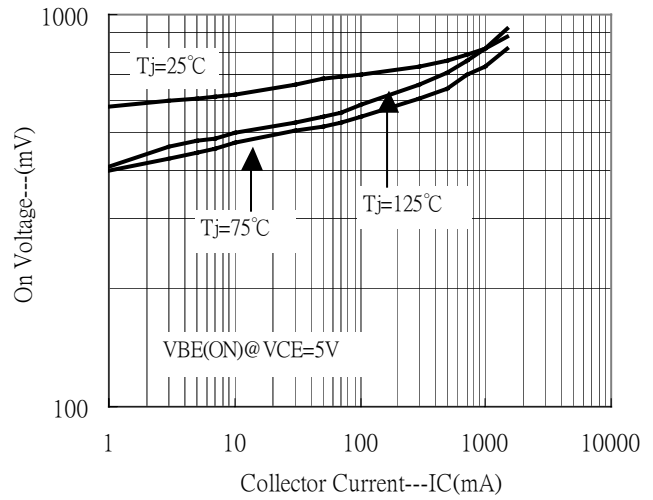

Power Derating Curve

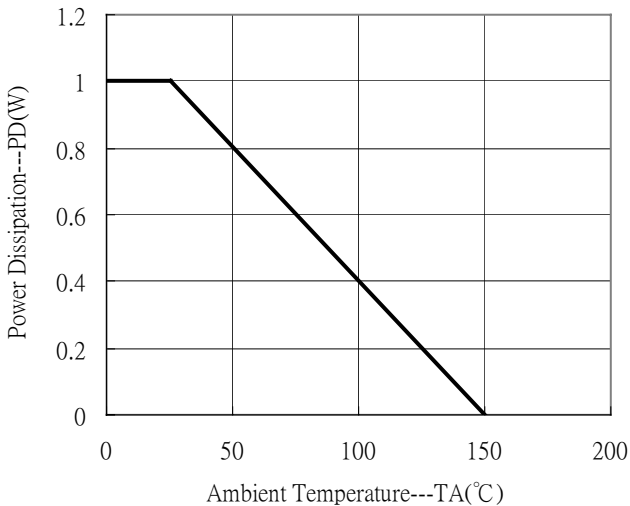

Power Derating Curve

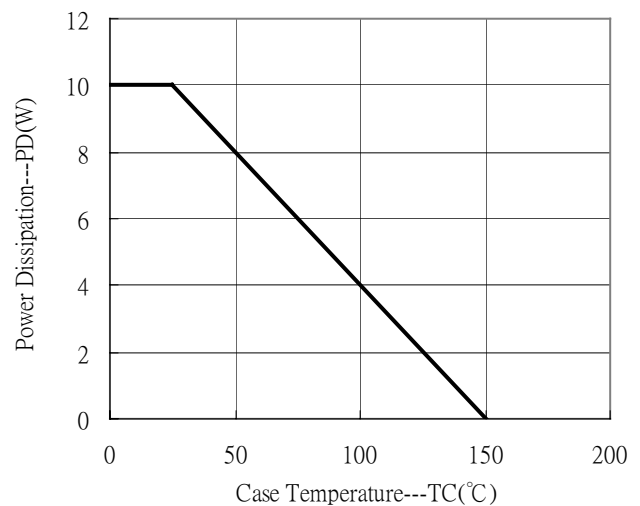

Reel Dimension

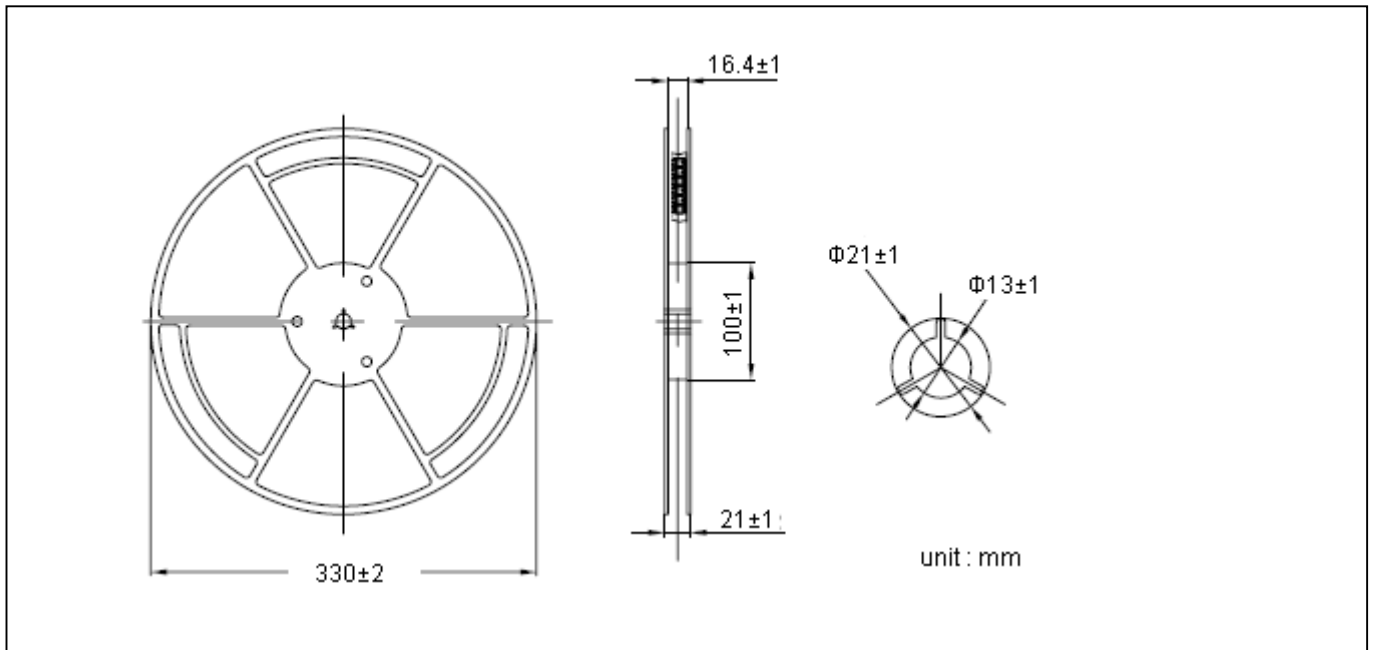

Carrier Tape Dimension

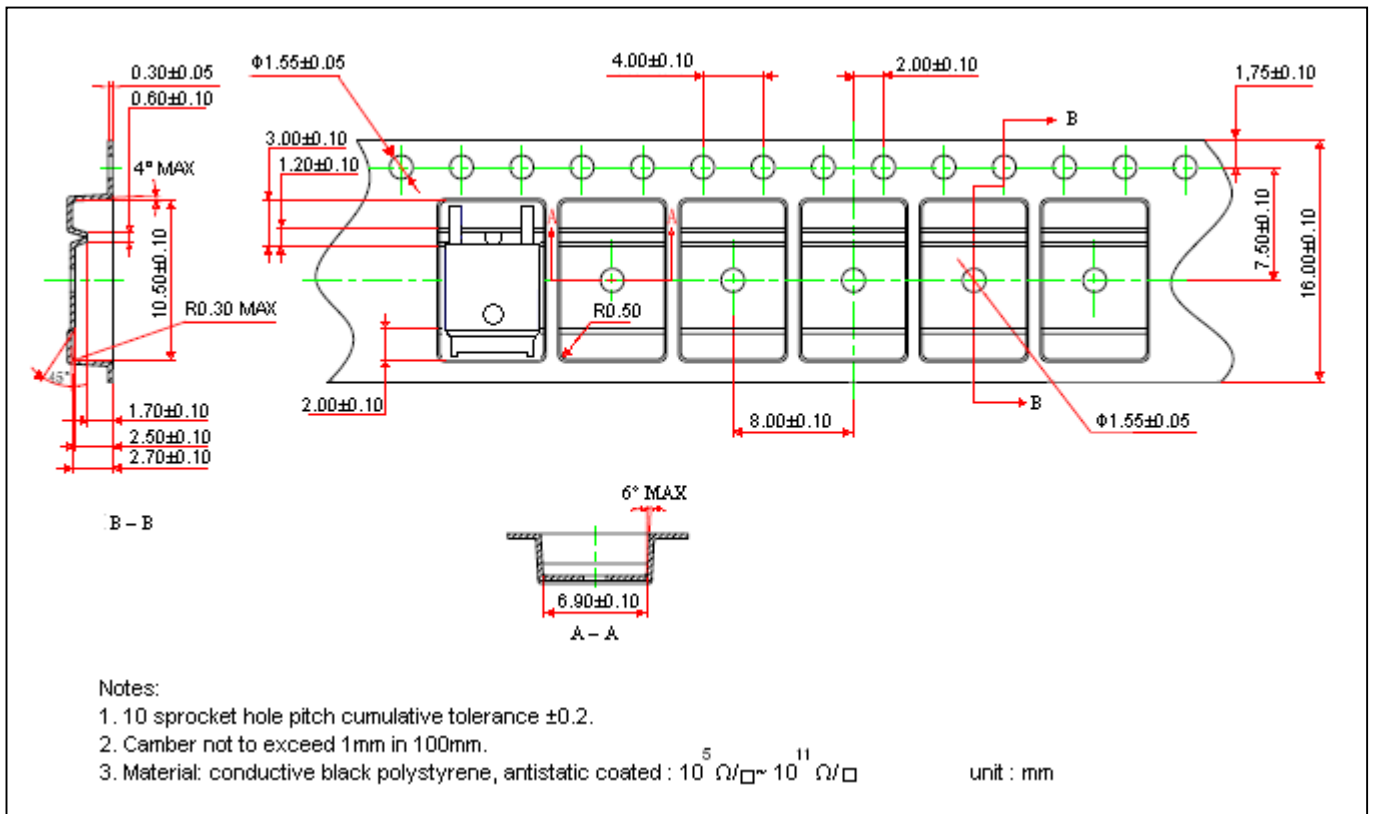



Typical Characteristics(Cont.)

Safe Operating Area

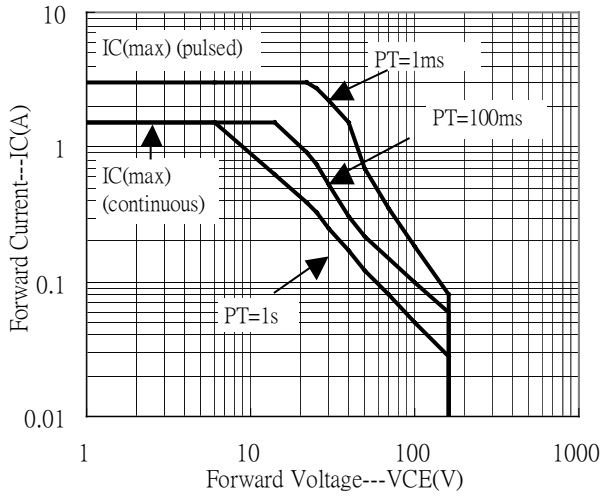

Recommended wave soldering condition

Product	Peak Temperature	Soldering Time
Pb-free devices	260 +0/-5 °C	5 +1/-1 seconds

Recommended temperature profile for IR reflow

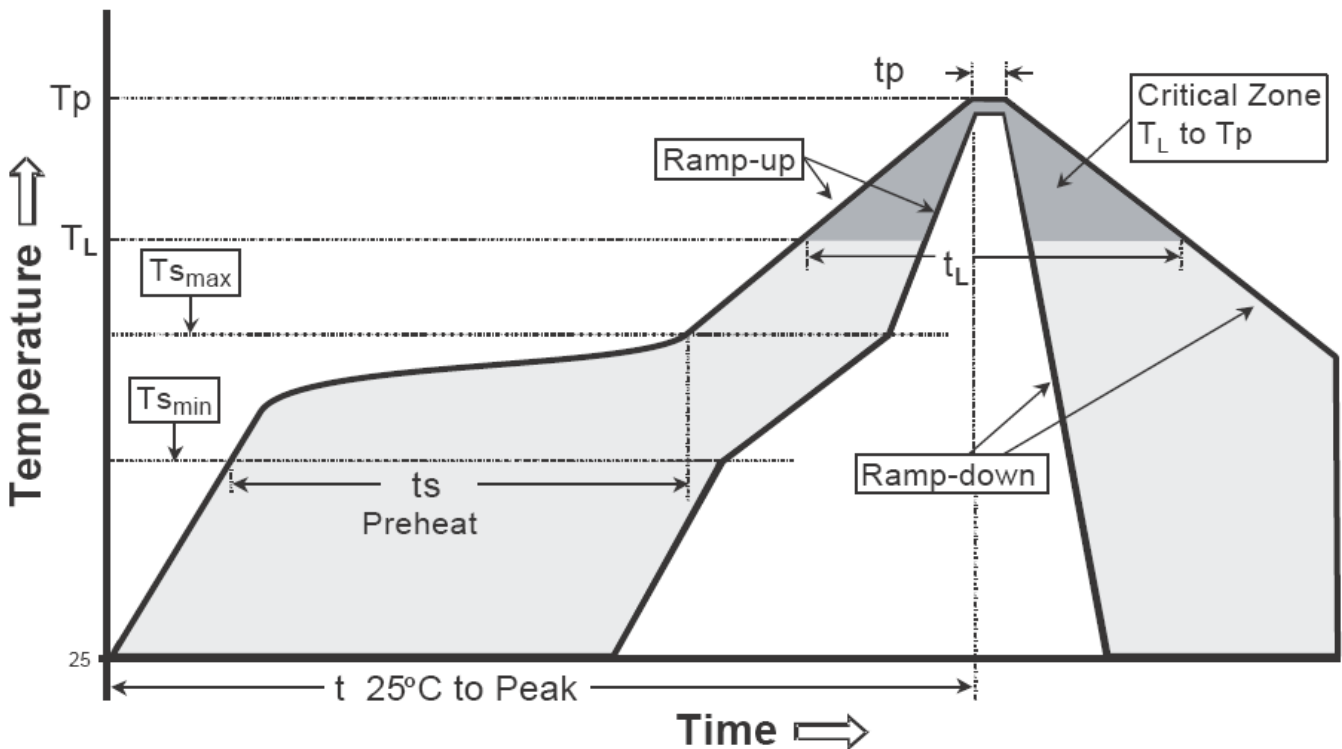

Profile feature	Sn-Pb eutectic Assembly	Pb-free Assembly
Average ramp-up rate (T _{smax} to T _p)	3°C/second max.	3°C/second max.
Preheat		
-Temperature Min(T _{s min})	100°C	150°C
-Temperature Max(T _{s max})	150°C	200°C
-Time(t _{s min} to t _{s max})	60-120 seconds	60-180 seconds
Time maintained above:		
-Temperature (T _L)	183°C	217°C
- Time (t _L)	60-150 seconds	60-150 seconds
Peak Temperature(T _p)	240 +0/-5 °C	260 +0/-5 °C
Time within 5°C of actual peak temperature(tp)	10-30 seconds	20-40 seconds
Ramp down rate	6°C/second max.	6°C/second max.
Time 25 °C to peak temperature	6 minutes max.	8 minutes max.

Note : All temperatures refer to topside of the package, measured on the package body surface.

TO-252 Dimension

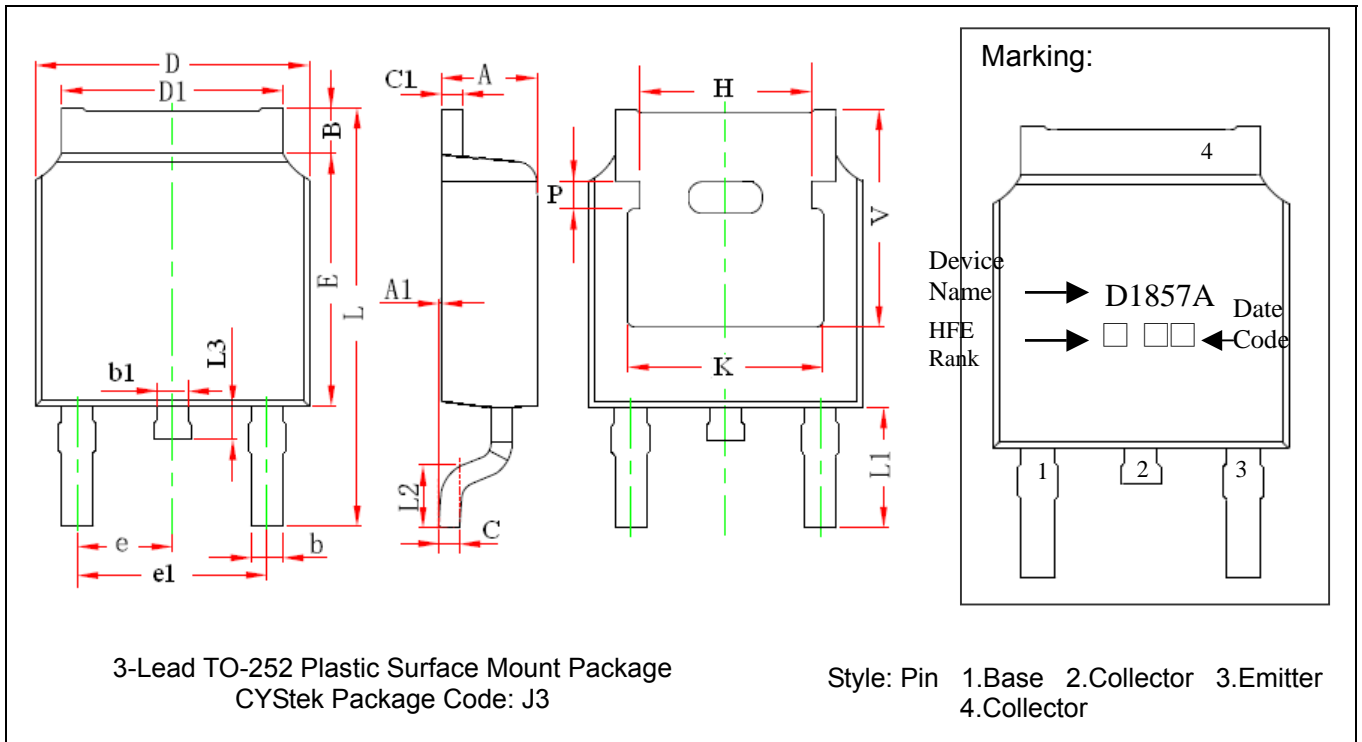

DIM	Inches		Millimeters		DIM	Inches		Millimeters	
	Min.	Max.	Min.	Max.		Min.	Max.	Min.	Max.
A	0.087	0.094	2.200	2.400	e	0.086	0.094	2.186	2.386
A1	0.000	0.005	0.000	0.127	e1	0.172	0.188	4.372	4.772
B	0.039	0.048	0.990	1.210	H	0.163	REF	4.140	REF
b	0.026	0.034	0.660	0.860	K	0.190	REF	4.830	REF
b1	0.026	0.034	0.660	0.860	L	0.386	0.409	9.800	10.400
C	0.018	0.023	0.460	0.580	L1	0.114	REF	2.900	REF
C1	0.018	0.023	0.460	0.580	L2	0.055	0.067	1.400	1.700
D	0.256	0.264	6.500	6.700	L3	0.024	0.039	0.600	1.000
D1	0.201	0.215	5.100	5.460	P	0.026	REF	0.650	REF
E	0.236	0.244	6.000	6.200	V	0.211	REF	5.350	REF

Notes: 1.Controlling dimension: millimeters.
 2.Maximum lead thickness includes lead finish thickness, and minimum lead thickness is the minimum thickness of base material.
 3.If there is any question with packing specification or packing method, please contact your local CYStek sales office.

Material:

- Lead : Pure tin plated.
- Mold Compound: Epoxy resin family, flammability solid burning class: UL94V-0.

Important Notice:

- All rights are reserved. Reproduction in whole or in part is prohibited without the prior written approval of CYStek.
- CYStek reserves the right to make changes to its products without notice.
- CYStek **semiconductor products are not warranted to be suitable for use in Life-Support Applications, or systems.**
- CYStek assumes no liability for any consequence of customer product design, infringement of patents, or application assistance.