

Low Vcesat NPN Epitaxial Planar Transistor

BTD2150AE3

Features

- Low VCE(sat), VCE(sat)=0.25 V (typical), at IC / IB = 2A / 50mA
- Excellent current gain characteristics
- Complementary to BTB1424AE3

Symbol

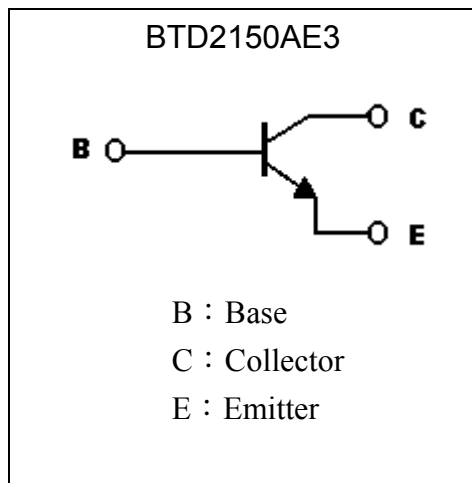

Outline

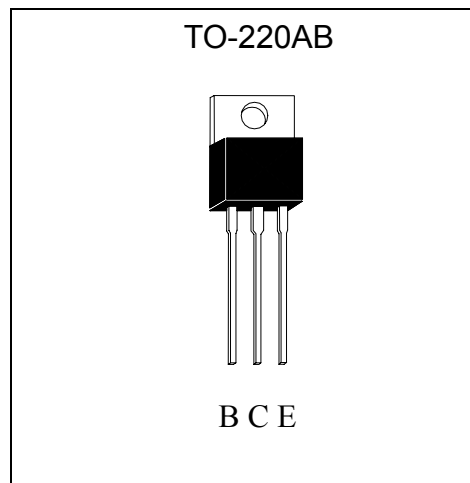

Absolute Maximum Ratings (Ta=25°C)

Parameter	Symbol	Limits	Unit
Collector-Base Voltage	V _{CB0}	80	V
Collector-Emitter Voltage	V _{CEO}	50	V
Emitter-Base Voltage	V _{EBO}	6	V
Collector Current (DC)	I _C	3	A
Collector Current (Pulse)	I _{CP}	7 (Note)	
Base Current	I _B	1	A
Power Dissipation (T _A =25°C)	P _D	1.8	W
Power Dissipation (T _C =25°C)		25	
Junction Temperature	T _j	150	°C
Storage Temperature	T _{stg}	-55~+150	°C

Note : Pulse test, pulse width≤380μs, duty cycle≤2%.



Characteristics (Ta=25°C)

Symbol	Min.	Typ.	Max.	Unit	Test Conditions
BV _{CB0}	80	-	-	V	I _C =50μA, I _E =0
BV _{CE0}	50	-	-	V	I _C =1mA, I _B =0
BV _{EB0}	6	-	-	V	I _E =50μA, I _C =0
I _{CB0}	-	-	10	μA	V _{CB} =80V, I _E =0
I _{EB0}	-	-	10	μA	V _{EB} =6V, I _C =0
*V _{CE(sat)}	-	0.25	0.5	V	I _C =2A, I _B =50mA
*V _{BE(sat)}	-	-	2	V	I _C =2A, I _B =200mA
*h _{FE}	180	-	820	-	V _{CE} =4V, I _C =500mA
f _T	-	15	-	MHz	V _{CE} =12V, I _C =200mA, f=10MHz
C _{ob}	-	50	-	pF	V _{CB} =10V, f=1MHz
t _{on}	-	0.8	-	μs	V _{CC} =20V, I _C =1A, I _{B1} =15mA, I _{B2} =-30mA, R _L =20Ω
t _{stg}	-	3	-	μs	
t _f	-	1.2	-	μs	

*Pulse Test : Pulse Width ≤380μs, Duty Cycle ≤2%

Classification Of hFE

Rank	R	S	T
Range	180~390	270~560	390~820

Characteristic Curves

Grounded Emitter Output Characteristics

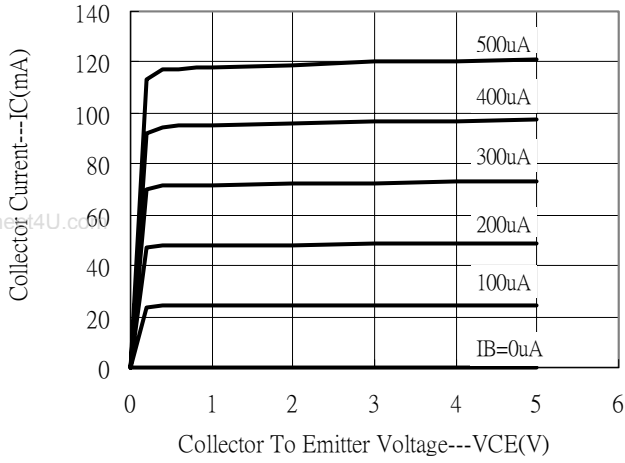

Grounded Emitter Output Characteristics

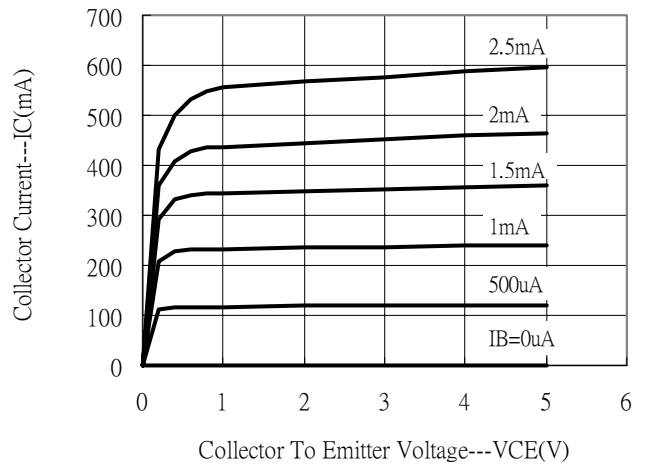

Grounded Emitter Output Characteristics

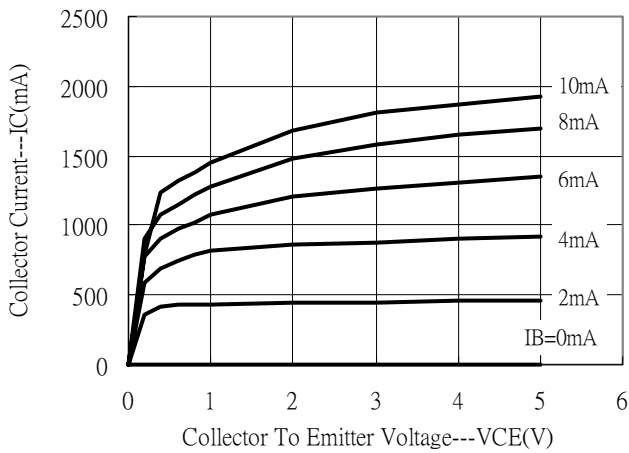

Grounded Emitter Output Characteristics

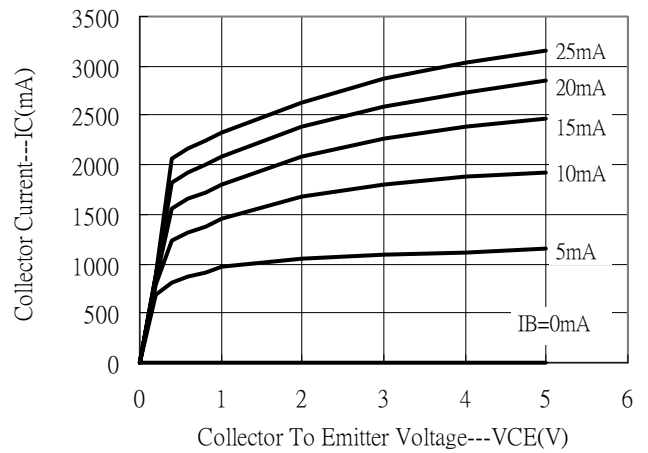

Current gain vs Collector current

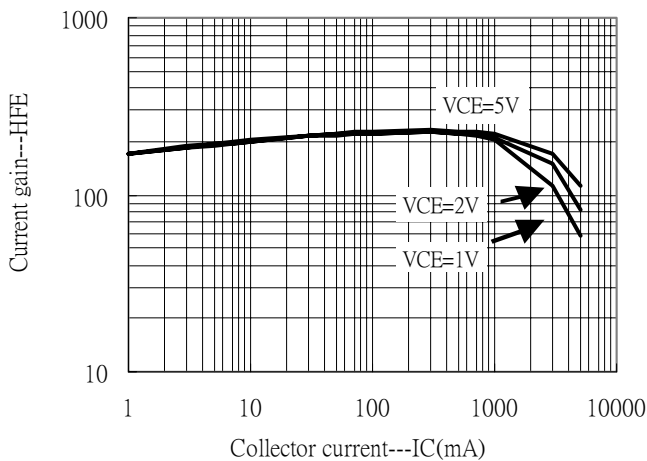

Saturation voltage vs Collector current

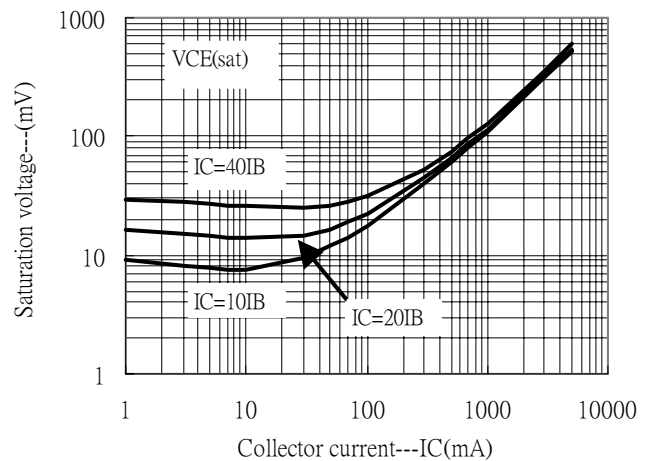



Saturation vottage vs Collector current

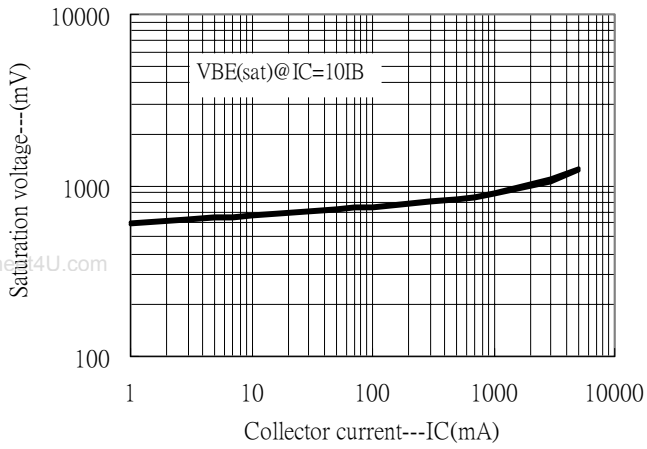

Power Derating Curve

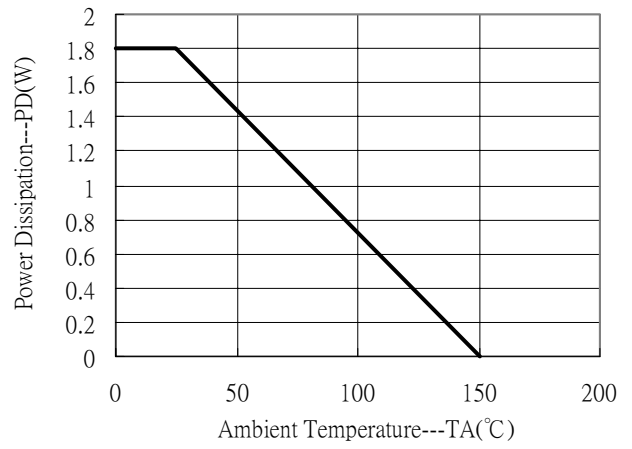

Power Derating Curve

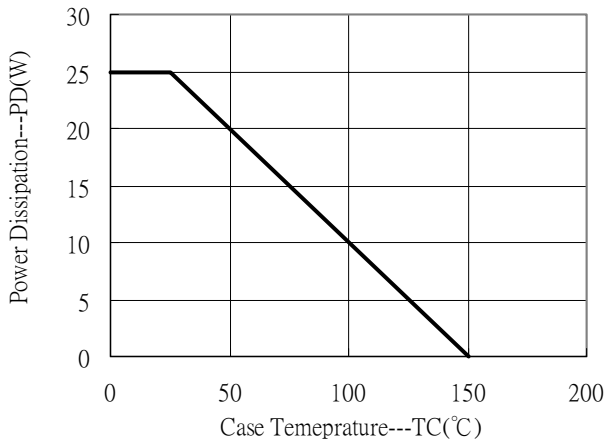

TO-220AB Dimension

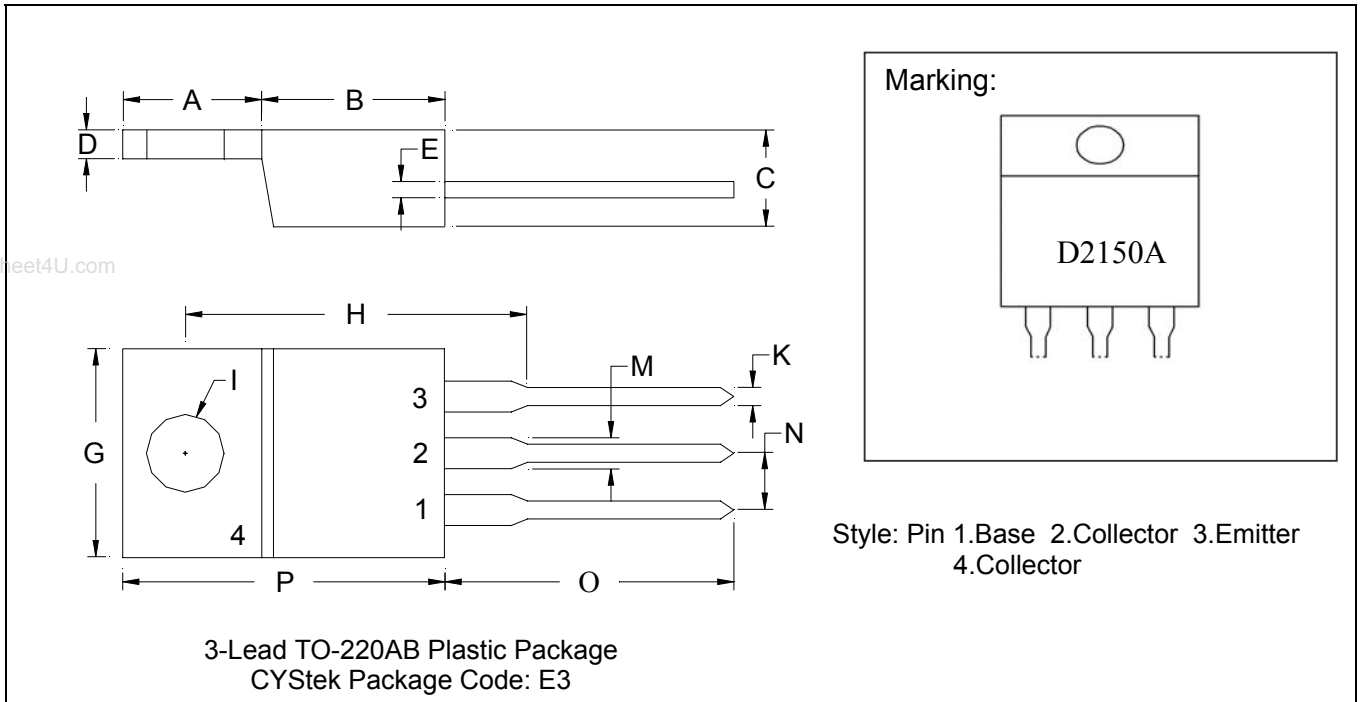

*: Typical

DIM	Inches		Millimeters		DIM	Inches		Millimeters	
	Min.	Max.	Min.	Max.		Min.	Max.	Min.	Max.
A	0.2197	0.2949	5.58	7.49	I	-	*0.1508	-	*3.83
B	0.3299	0.3504	8.38	8.90	K	0.0295	0.0374	0.75	0.95
C	0.1732	0.185	4.40	4.70	M	0.0449	0.0551	1.14	1.40
D	0.0453	0.0547	1.15	1.39	N	-	*0.1000	-	*2.54
E	0.0138	0.0236	0.35	0.60	O	0.5000	0.5618	12.70	14.27
G	0.3803	0.4047	9.66	10.28	P	0.5701	0.6248	14.48	15.87
H	-	*0.6398	-	*16.25					

Notes: 1.Controlling dimension: millimeters.
 2.Maximum lead thickness includes lead finish thickness, and minimum lead thickness is the minimum thickness of base material.
 3.If there is any question with packing specification or packing method, please contact your local CYStek sales office.

Material:

- Lead: 42 Alloy ; solder plating
- Mold Compound: Epoxy resin family, flammability solid burning class: UL94V-0

Important Notice:

- All rights are reserved. Reproduction in whole or in part is prohibited without the prior written approval of CYStek.
- CYStek reserves the right to make changes to its products without notice.
- CYStek **semiconductor products are not warranted to be suitable for use in Life-Support Applications, or systems.**
- CYStek assumes no liability for any consequence of customer product design, infringement of patents, or application assistance.