

**Low  $V_{CE(sat)}$  NPN Planar Transistor**

# BTD5765B3

**Features**

- High current capability
- Low collector-to-emitter saturation voltage
- High allowable power dissipation

**Applications**

- Relay drivers, lamp drivers, motor drivers, strobes

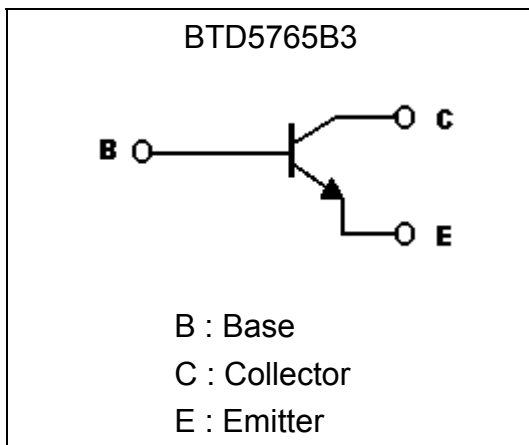
**Symbol**

**Absolute Maximum Ratings (Ta=25°C)**

Parameter	Symbol	Limits	Unit
Collector-Base Voltage	$V_{CBO}$	15	V
Collector-Emitter Voltage	$V_{CEO}$	10	V
Emitter-Base Voltage	$V_{EBO}$	7	V
Collector Current (DC)	$I_C$	5	A
Collector Current (Pulse)	$I_{CP}$	9	A
Collector Power Dissipation (Note)	$P_D$	550	mW
Junction Temperature	$T_j$	150	°C
Storage Temperature	$T_{stg}$	-55~+150	°C

Note : when a device is mounted on a glass epoxy board, measuring 35mm×30mm×1mm.

**Characteristics (Ta=25°C)**

Symbol	Min.	Typ.	Max.	Unit	Test Conditions
$BV_{CBO}$	15	-	-	V	$I_C=100\mu A, I_E=0$
$BV_{CEO}$	10	-	-	V	$I_C=1mA, I_B=0$
$BV_{EBO}$	7	-	-	V	$I_E=10\mu A, I_C=0$
$I_{CBO}$	-	-	100	nA	$V_{CB}=15V, I_E=0$
$I_{EBO}$	-	-	100	nA	$V_{EB}=5V, I_C=0$
$*V_{CE(sat)1}$	-	-	180	mV	$I_C=1.5A, I_B=30mA$
$*V_{CE(sat)2}$	-	230	350	mV	$I_C=3A, I_B=60mA$
$*V_{BE(sat)}$	-	-	0.95	1.2V	$I_C=1.5A, I_B=30mA$
$*h_{FE1}$	450	-	-	-	$V_{CE}=2V, I_C=500mA$
$*h_{FE2}$	400	-	800	-	$V_{CE}=2V, I_C=2A$
$*h_{FE3}$	200	-	-	-	$V_{CE}=2V, I_C=5A$
$f_T$	-	170	-	MHz	$V_{CE}=6V, I_C=50mA, f=100MHz$
Cob	-	25	-	pF	$V_{CB}=10V, f=1MHz$

\*Pulse Test: Pulse Width  $\leq 380\mu s$ , Duty Cycle  $\leq 2\%$

**Characteristic Curves**

Output Characteristics

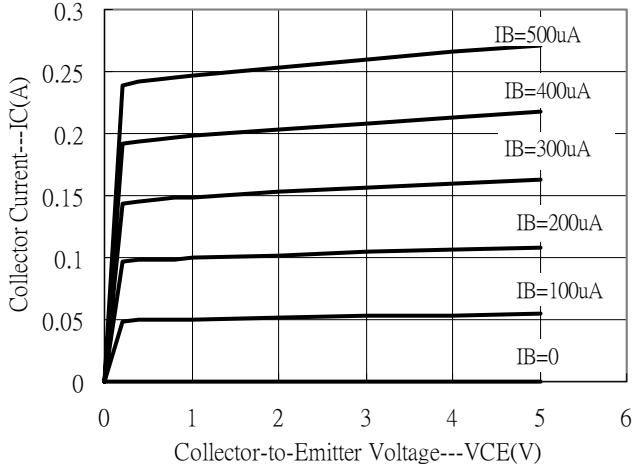

Output Characteristics

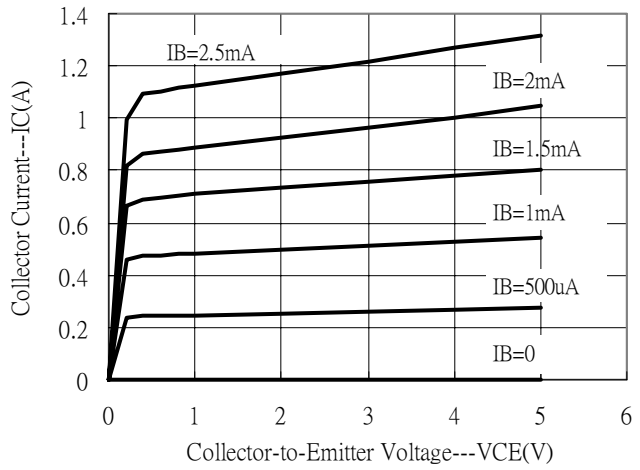

Output Characteristics

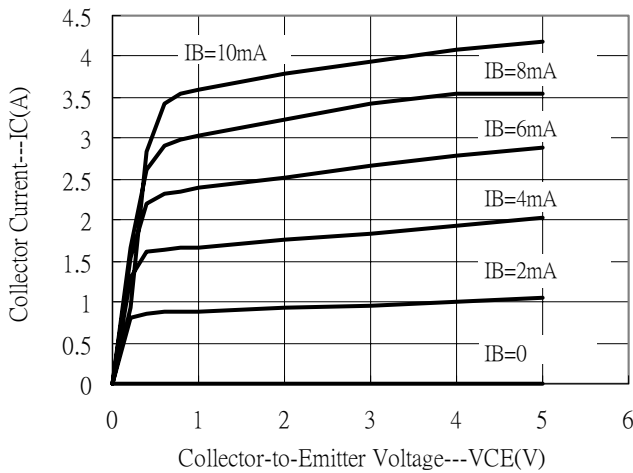

Output Characteristics

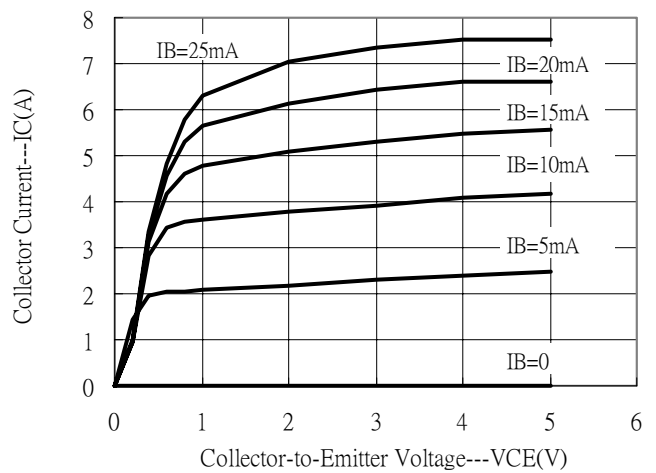

Current Gain vs Collector Current

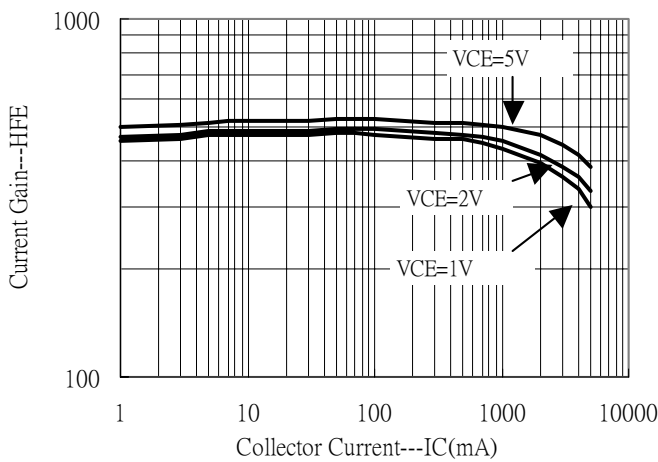

Saturation Voltage vs Collector Current

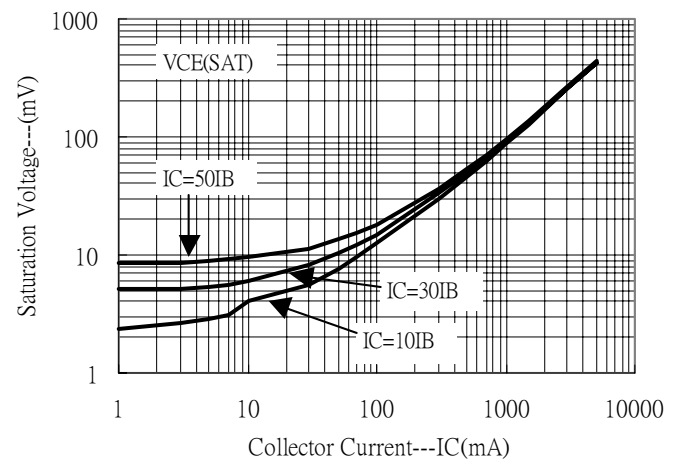



Saturation Voltage vs Collector Current

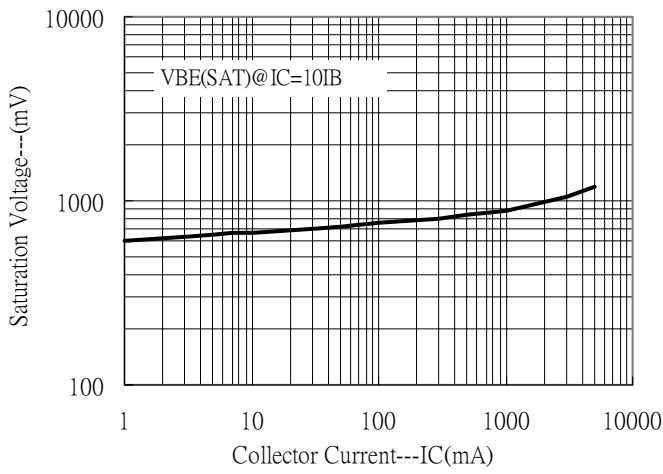

Power Derating Curve

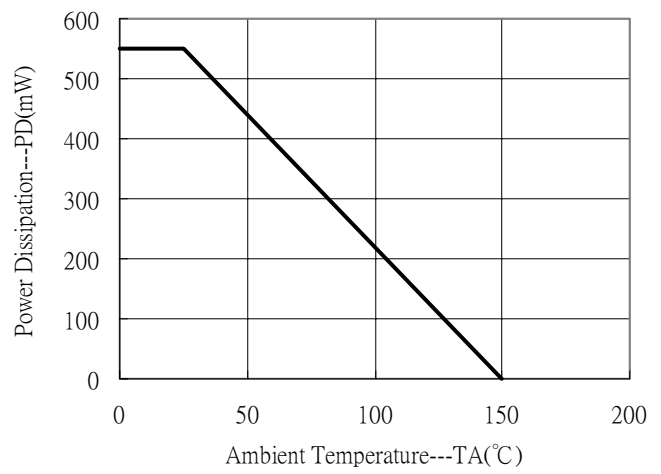

**TO-92SP Dimension**

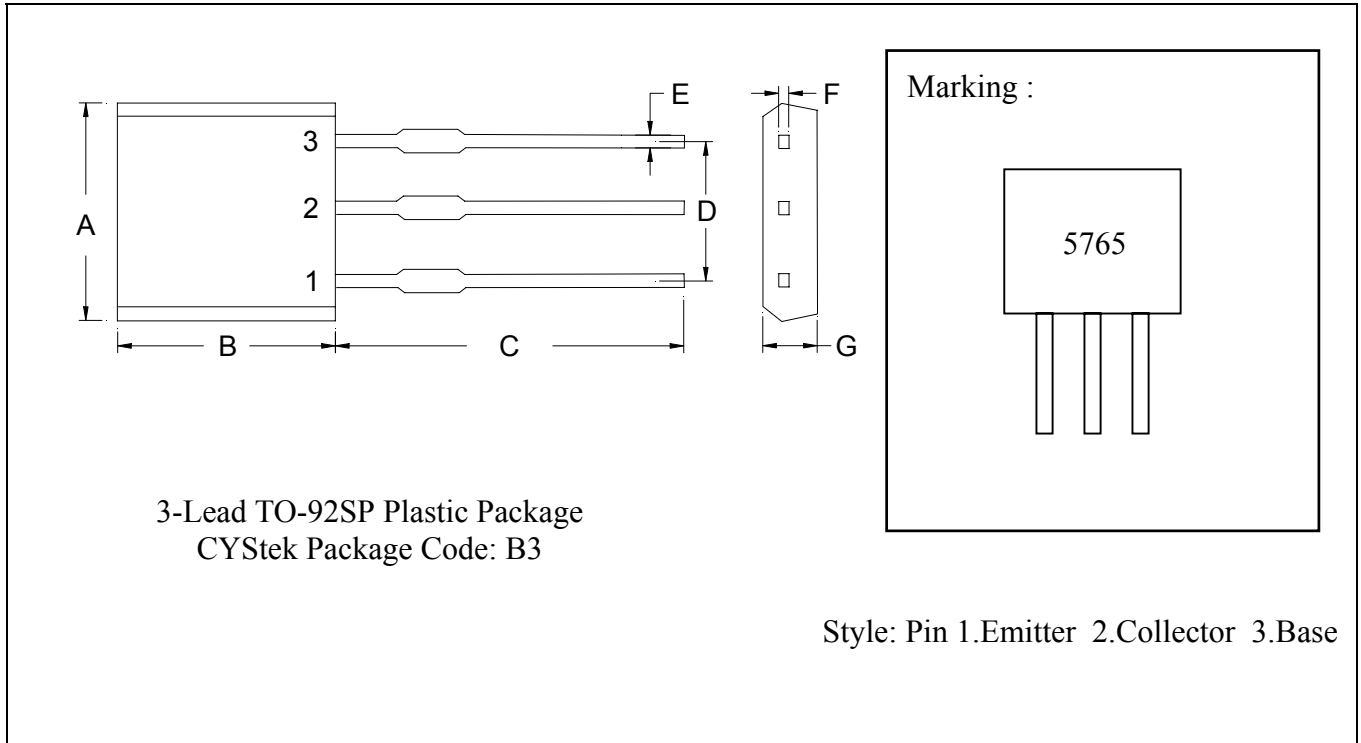

\*: Typical

DIM	Inches		Millimeters		DIM	Inches		Millimeters	
	Min.	Max.	Min.	Max.		Min.	Max.	Min.	Max.
A	0.1450	0.1650	3.70	4.20	E	0.0160	0.0240	0.41	0.61
B	0.1063	0.1300	2.70	3.30	F	-	*0.0150	-	*0.38
C	0.5000	-	12.7	-	G	0.0800	0.1050	2.03	2.67
D	-	*0.1000	-	*2.54					

**Notes:** 1. Controlling dimension: millimeters.  
 2. Maximum lead thickness includes lead finish thickness, and minimum lead thickness is the minimum thickness of base material.  
 3. If there is any question with packing specification or packing method, please contact your local CYStek sales office.

**Material:**

- Lead: 42 Alloy; solder plating
- Mold Compound: Epoxy resin family, flammability solid burning class: UL94V-0

**Important Notice:**

- All rights are reserved. Reproduction in whole or in part is prohibited without the prior written approval of CYStek.
- CYStek reserves the right to make changes to its products without notice.
- CYStek **semiconductor products are not warranted to be suitable for use in Life-Support Applications, or systems.**
- CYStek assumes no liability for any consequence of customer product design, infringement of patents, or application assistance.