

General Purpose NPN Epitaxial Planar Transistor

BTNA42N3

Description

- High breakdown voltage. ($V_{CE0}=300V$)
- Low collector output capacitance. (Typ. 3pF at $V_{CB} = 30V$)
- Ideal for chroma circuit.

Symbol

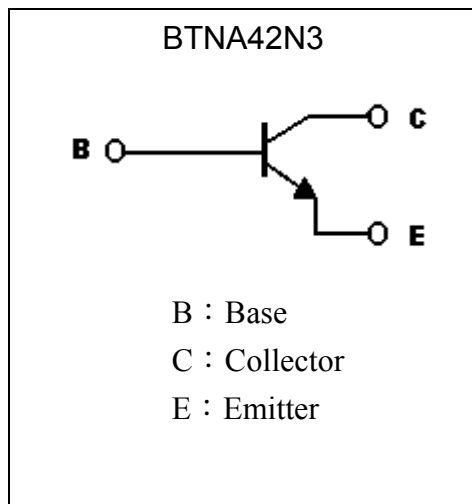

Outline

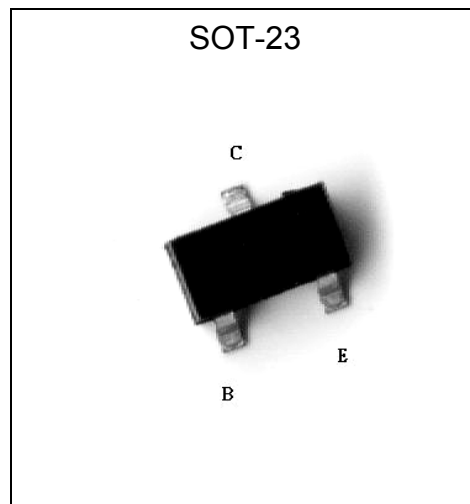

Absolute Maximum Ratings ($T_a=25^{\circ}C$)

Parameter	Symbol	Limits	Unit
Collector-Base Voltage	V_{CB0}	300	V
Collector-Emitter Voltage	V_{CE0}	300	V
Emitter-Base Voltage	V_{EB0}	6	V
Collector Current	I_C	500	mA
Power Dissipation	P_d	225 (Note)	mW
Thermal Resistance, Junction to Ambient	$R_{\theta JA}$	556	$^{\circ}C/W$
Junction Temperature	T_j	150	$^{\circ}C$
Storage Temperature	T_{stg}	-55~+150	$^{\circ}C$

Note : When mounted on a FR-5 board with area measuring 1.0×0.75×0.062 in.

Characteristics (Ta=25°C)

Symbol	Min.	Typ.	Max.	Unit	Test Conditions
BV _{CB0}	300	-	-	V	I _c =50μA
BV _{CEO}	300	-	-	V	I _c =1mA
BV _{EBO}	6	-	-	V	I _E =50μA
I _{CB0}	-	-	100	nA	V _{CB} =200V
I _{EBO}	-	-	100	nA	V _{EB} =6V
*V _{CE(sat)1}	-	0.1	0.5	V	I _c =20mA, I _B =2mA
*V _{CE(sat)2}	-	-	2.	V	I _c =30mA, I _B =1.5mA
*V _{BE(sat)}	-	-	0.9	V	I _c =20mA, I _B =2mA
*h _{FE1}	25	-	-	-	V _{CE} =10V, I _c =1mA
*h _{FE2}	52	-	270	-	V _{CE} =10V, I _c =10mA
*h _{FE3}	40	-	-	-	V _{CE} =10V, I _c =30mA
f _T	50	-	-	MHz	V _{CE} =20V, I _c =10mA, f=100MHz
C _{ob}	-	2	3.0	pF	V _{CB} =20V, f=1MHz

*Pulse Test: Pulse Width ≤380μs, Duty Cycle≤2%

Classification Of hFE2

Rank	K	P	Q
Range	52~120	82~180	120~270

Characteristic Curves

Current Gain vs Collector Current

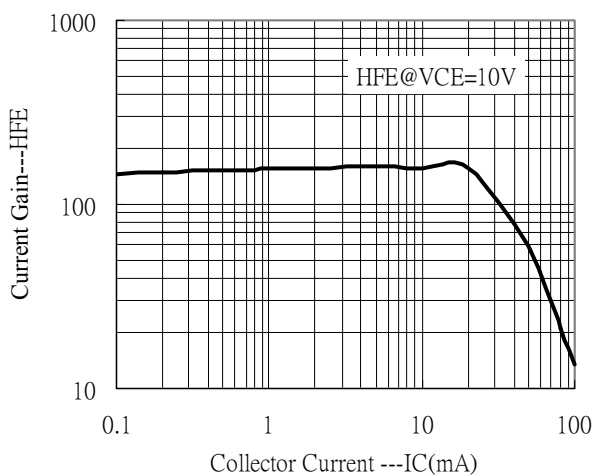

Saturation Voltage vs Collector Current

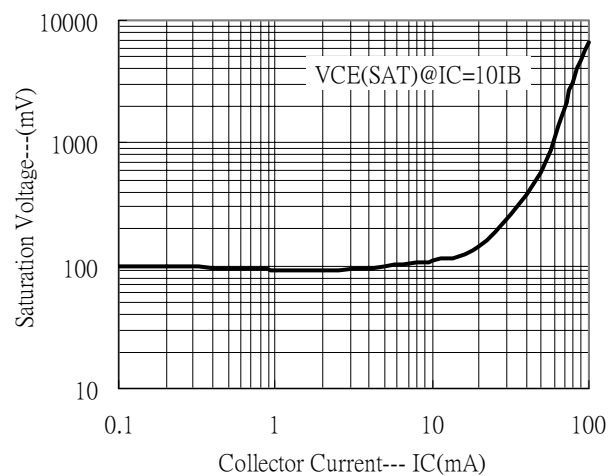

Saturation Voltage vs Collector Current

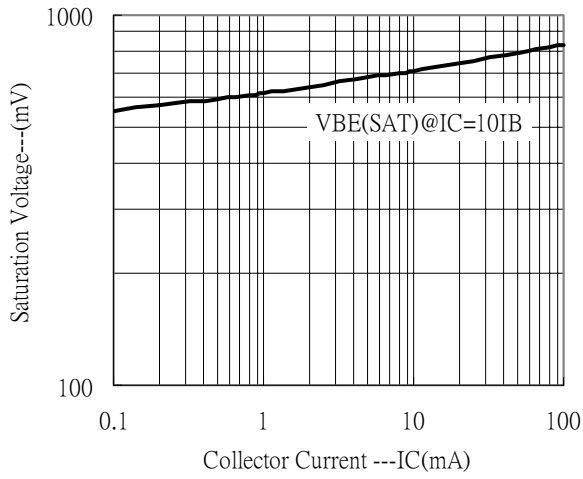

Cutoff Frequency vs Collector Current

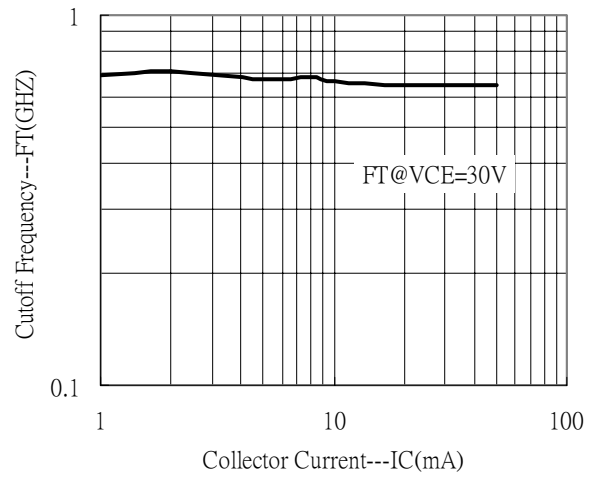

Power Derating Curve

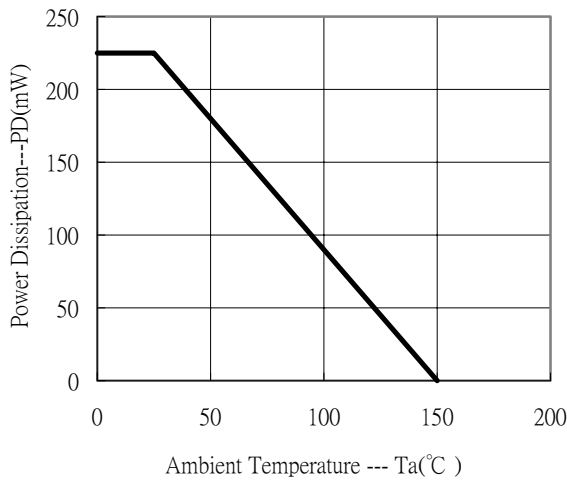

SOT-23 Dimension

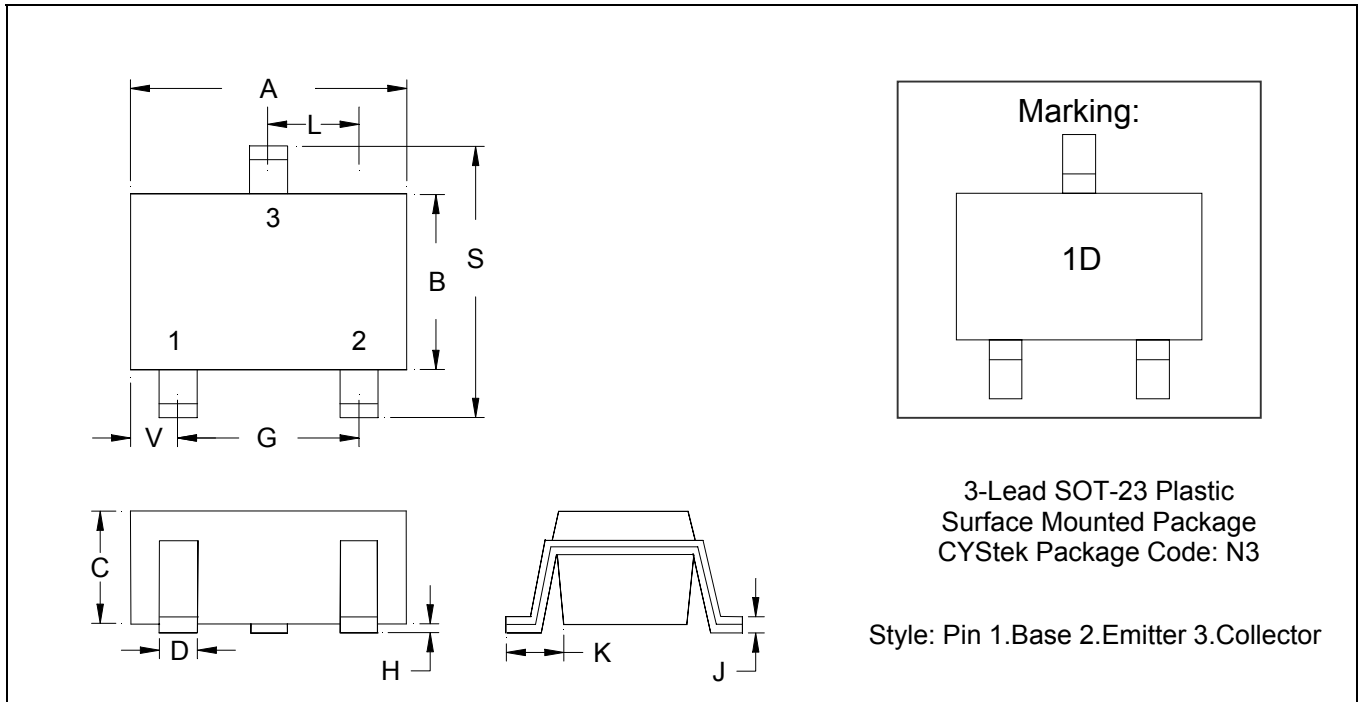

*: Typical

DIM	Inches		Millimeters		DIM	Inches		Millimeters	
	Min.	Max.	Min.	Max.		Min.	Max.	Min.	Max.
A	0.1102	0.1204	2.80	3.04	J	0.0034	0.0070	0.085	0.177
B	0.0472	0.0630	1.20	1.60	K	0.0128	0.0266	0.32	0.67
C	0.0335	0.0512	0.89	1.30	L	0.0335	0.0453	0.85	1.15
D	0.0118	0.0197	0.30	0.50	S	0.0830	0.1083	2.10	2.75
G	0.0669	0.0910	1.70	2.30	V	0.0098	0.0256	0.25	0.65
H	0.0005	0.0040	0.013	0.10					

- Notes: 1.Controlling dimension: millimeters.
 2.Maximum lead thickness includes lead finish thickness, and minimum lead thickness is the minimum thickness of base material.
 3.If there is any question with packing specification or packing method, please contact your local CYStek sales office.

Material:

- Lead: 42 Alloy ; solder plating
- Mold Compound: Epoxy resin family, flammability solid burning class: UL94V-0

Important Notice:

- All rights are reserved. Reproduction in whole or in part is prohibited without the prior written approval of CYStek.
- CYStek reserves the right to make changes to its products without notice.
- CYStek **semiconductor products are not warranted to be suitable for use in Life-Support Applications, or systems.**
- CYStek assumes no liability for any consequence of customer product design, infringement of patents, or application assistance.