

BriLux 1W Light Source

BTP-187XXCQ-XX-XX

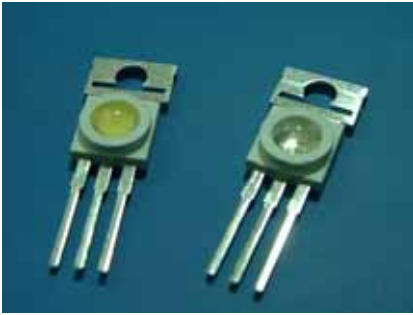

[Note 1]

Package Dimension

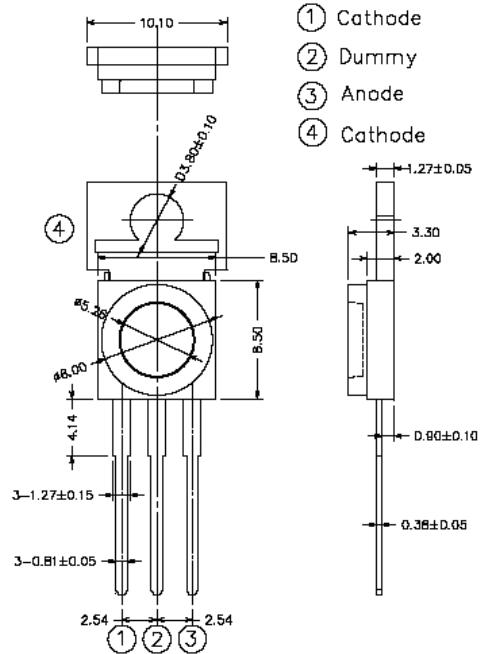

Tolerance: ± see spec

Unit: ± mm

Features

- Highest Lumen Per Watt
- Long Operational Life
- More Energy Efficient
- IC Compatible
- Low DC Voltage
- Superior ESD Protection
- Smallest Footprint

Applications

- Accent Lighting
- Automotive Exterior/Interior Light
- High Power Back Light
- Reading Light
- Marine/Miner's Lighting
- Portable Lighting

Optical Characteristics at $T_a=25^{\circ}\text{C}$, $I_F=350\text{mA}$

PART NUMBER	LED CHIP	Lens Color	Wavelength/CCT Range (nm/K)		Drive Voltage	Luminous Flux @350mA(lm)	VIEW ANGLE
	MATERIAL		Min/Max	Typ.	Typ.	2θ _{1/2} (deg)	
BTP-187NRCQ-XX-17	AllnGaP	Water Clear	620~635		2.60V	17 lm ^[2]	90
BTP-187YECQ-XX-17	AllnGaP	Water Clear	585~595		2.60V	17 lm ^[2]	90
BTP-187BLCQ-XX-08	AllnGaN	Water Clear	460~470		3.60V	6 lm ^[2]	90
BTP-187GBCQ-XX-10	AllnGaN	Water Clear	470~480		3.60V	10 lm ^[2]	90
BTP-187PGCQ-XX-15	AllnGaN	Water Clear	520~530		3.60V	15lm ^[2]	90
BTP-187WHCQ-XX-30	AllnGaN	Water Clear	3000K	8000K	3.60V	30 lm ^[2]	90

Note:

1) Picture for illustration purpose only. Please refer to outline dimension for actual package size.

2) Due to the CIE eye response curve in the wavelength range, the minimum luminous flux will vary over the wavelength range of λ_D . For example, luminous flux will vary from a minimum of 4.5lm at 460 to a typical of 15 lm at 480nm nm due to this effect.



BriLux 1W Light Source

BTP-187XXCQ-XX-XX

Absolute Maximum Ratings at $T_a=25^{\circ}\text{C}$

Parameter	Red/Yellow	White/Blue
DC Forward Current (mA) ^[1]	300	350
Peak Pulsed Forward Current (mA)	350	500
Average Forward Current (mA)	300	300
Reverse Voltage (V)	5	5
LED Junction Temperature ($^{\circ}\text{C}$) ^[3]	120	120
Thermal Resistance without heatsink ($^{\circ}\text{C}/\text{W}$)	80	80
Storage Temperature ($^{\circ}\text{C}$)	-20 to +80	-20 to +80
Operating Temperature ($^{\circ}\text{C}$)	-10 to +70	-10 to +70

Application Notes:

1. Proper forward current must be observed to maintain the junction temperature below maximum rating
2. Although all products listed are class one ESD protection (+/- 1KV by HBM mode), care must be fully taken when handling products
3. Specification is subjected to change for improvements without notice.



WARNING

This range of LEDs is produced with die having a high radiant flux. Care must be taken when viewing the product at close range as the light may be intense enough to cause damage to the human eye.

Note: Industry standard procedures regarding static must be observed when handling this product.

BriLux 1W Light Source

BTP-187XXCQ-XX-XX

Typical Electro-Optical Characteristics Curves at $T_a=25^\circ\text{C}$

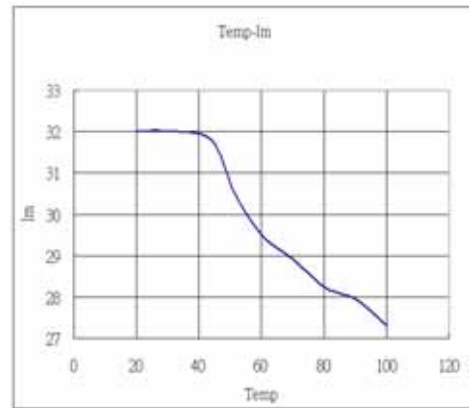
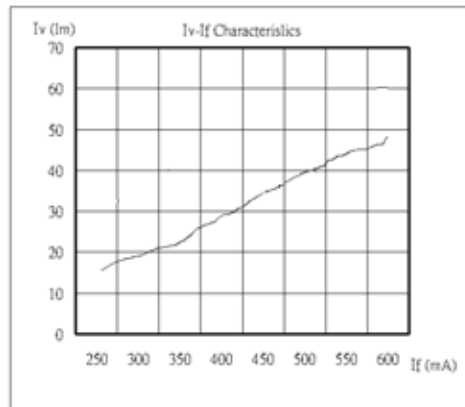
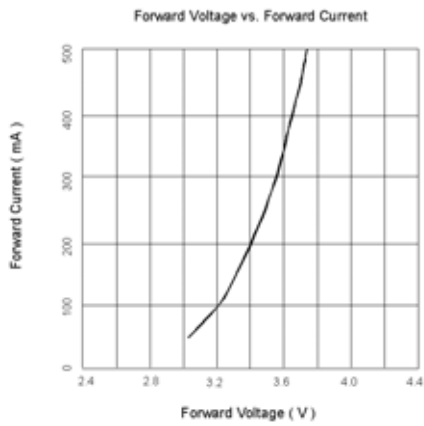
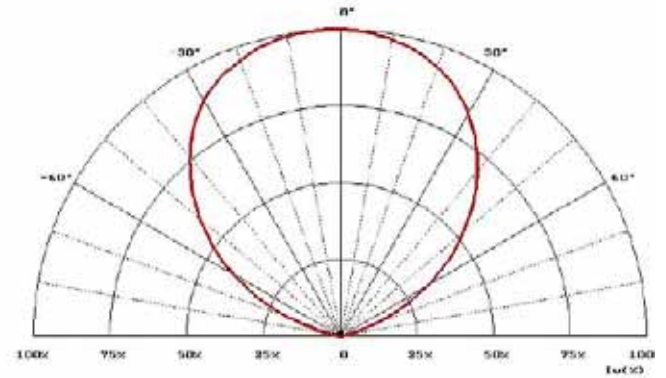
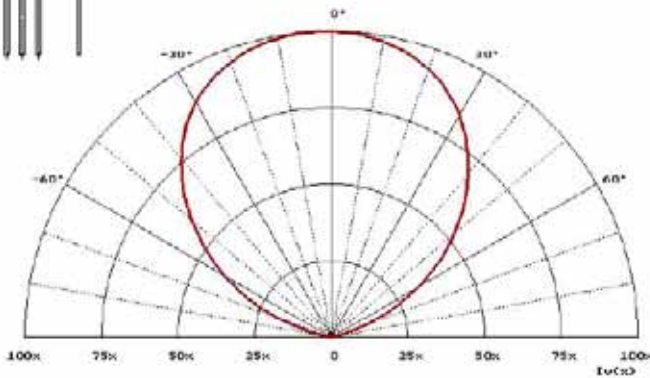
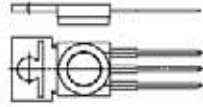

BriLux 1W Light Source

BTP-187XXCQ-XX-XX

Recommended Soldering Pattern

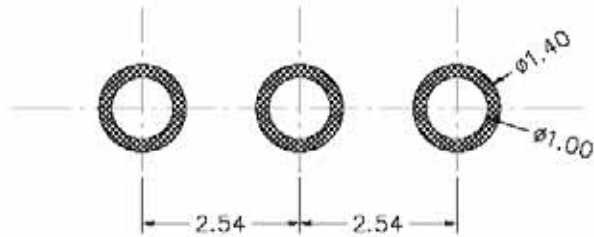

Unit: mm

Important Notes:

- The information contained herein is presented only as a Guide for the application of our products. Brilliance Technologies assumes no responsibility for any infringement of intellectual property or other rights of the third parties which may result from its use.
- Brilliance Technologies continually improves the quality of our products. Nevertheless, semiconductor devices in general can malfunction or fail due to their inherent electrical sensitivity and vulnerability to physical stress. It is the responsible of the customer, when using Brilliance Technologies products, to comply with the standard of safety in making a safe design for the entire system, and to avoid situations in which a malfunction or failure of such Brilliance Technologies products cause loss of human life, bodily injury or damage to property.
- Brilliance Technologies products listed in this data sheet are intended for usage in general electronics and/or non-commercial or industrial lighting products. These products are neither intended nor warranted for usage in equipment that requires extraordinarily high quality and/or reliability or a malfunction or failure of which may cause loss of human life or bodily injury.
- In developing your design, please ensure that Brilliance Technologies products are used within specified operating ranges as set forth in the most recent Brilliance Technologies data sheets.

BT-Rev. 1.0B20040917

Specifications are subject to change for improvement without notice.

Copyright © 2003 Brilliance Technologies Co., Ltd. All rights reserved.