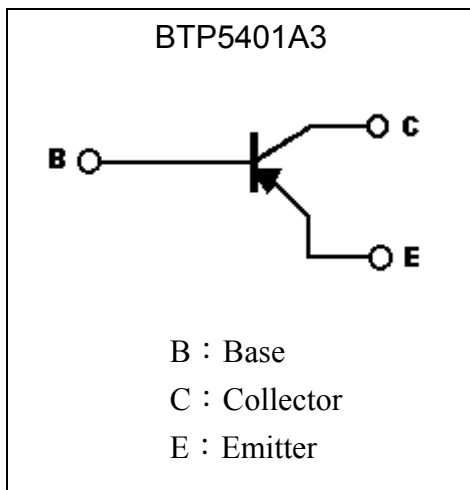
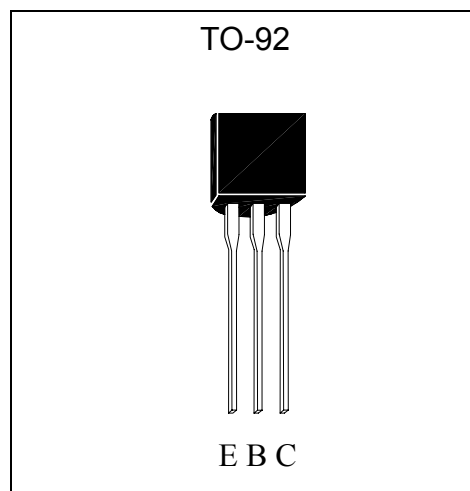

General Purpose PNP Epitaxial Planar Transistor

BTP5401A3

Description

- The BTP5401A3 is designed for general purpose amplification.
- Large I_C , $I_{C(Max)} = -0.6A$
- High BV_{CEO} , $BV_{CEO} = -150V$
- Complementary to BTN5551A3.

Symbol

Outline

Absolute Maximum Ratings ($T_a = 25^\circ C$)

Parameter	Symbol	Limits	Unit
Collector-Base Voltage	V_{CBO}	-160	V
Collector-Emitter Voltage	V_{CEO}	-150	V
Emitter-Base Voltage	V_{EBO}	-5	V
Collector Current	I_C	-0.6	A
Power Dissipation	P_d	625	mW
Thermal Resistance, Junction to Ambient	$R_{\theta JA}$	200	$^\circ C/W$
Junction Temperature	T_j	150	$^\circ C$
Storage Temperature	T_{stg}	-55~+150	$^\circ C$

**Characteristics (Ta=25°C)**

Symbol	Min.	Typ.	Max.	Unit	Test Conditions
BVCBO	-160	-	-	V	IC=-100μA
BVCEO	-150	-	-	V	IC=-1mA
BVEBO	-5	-	-	V	IE=-10μA
ICBO	-	-	-50	nA	VCB=-120V
IEBO	-	-	-50	nA	VEB=-3V
*VCE(sat) 1	-	-	-0.2	V	IC=-10mA, IB=-1mA
*VCE(sat) 2	-	-	-0.5	V	IC=-50mA, IB=-5mA
*VBE(sat) 1	-	-	-1	V	IC=-10mA, IB=-1mA
*VBE(sat) 2	-	-	-1	V	IC=-50mA, IB=-5mA
hFE 1	50	-	-	-	VCE=-5V, IC=-1mA
hFE 2	56	-	390	-	VCE=-5V, IC=-10mA
hFE 3	50	-	-	-	VCE=-5V, IC=-50mA
fT	100	-	300	MHz	VCE=-10V, IC=-10mA, f=100MHz
Cob	-	-	6	pF	VCB=-10V, f=1MHz

*Pulse Test: Pulse Width ≤380μs, Duty Cycle ≤2%

Classification Of hFE 2

Rank	K	P	Q	R
Range	56~120	82~180	120~270	180~390



Characteristic Curves

Current Gain vs Collector Current

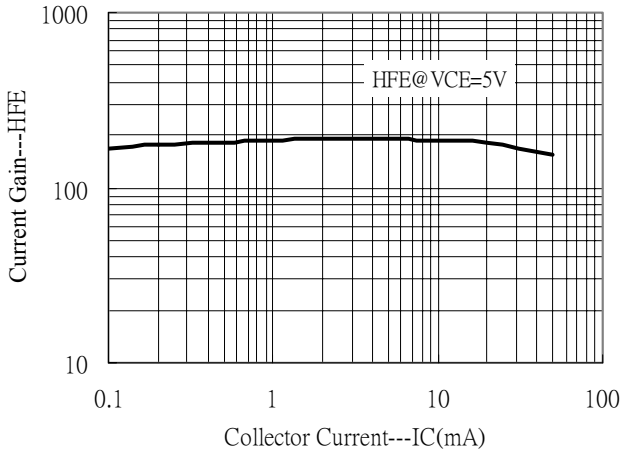

Saturation Voltage vs Collector Current

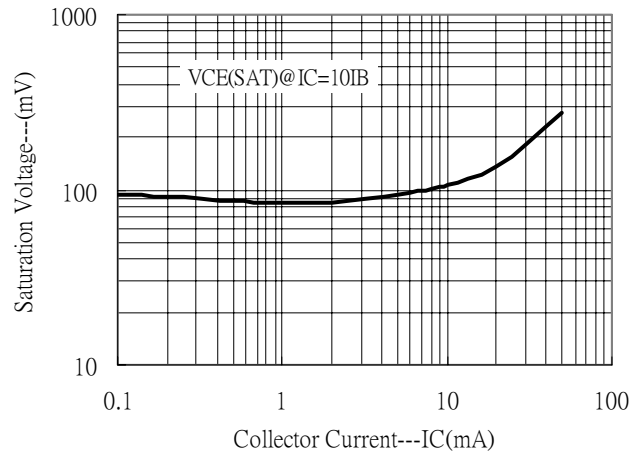

Saturation Voltage vs Collector Current

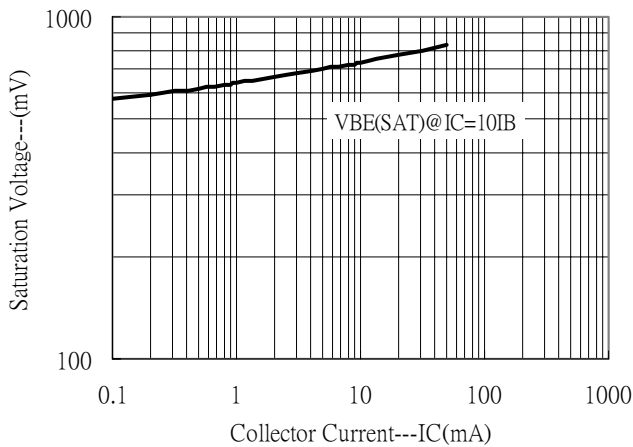

Cutoff Frequency vs Collector Current

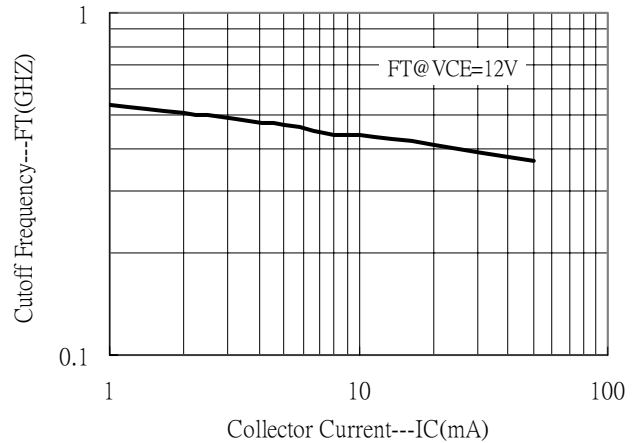

Power Derating Curve

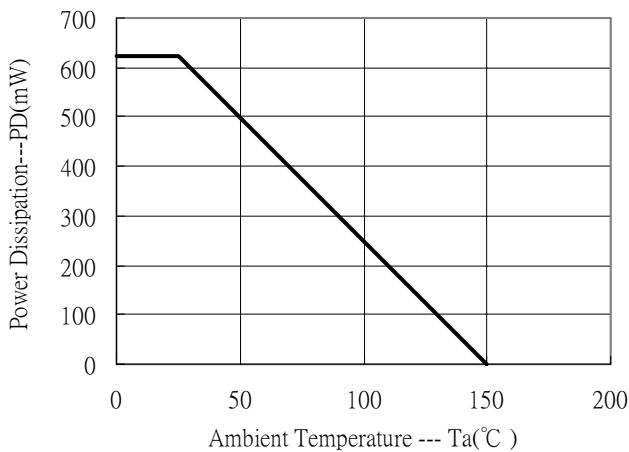

TO-92 Dimension

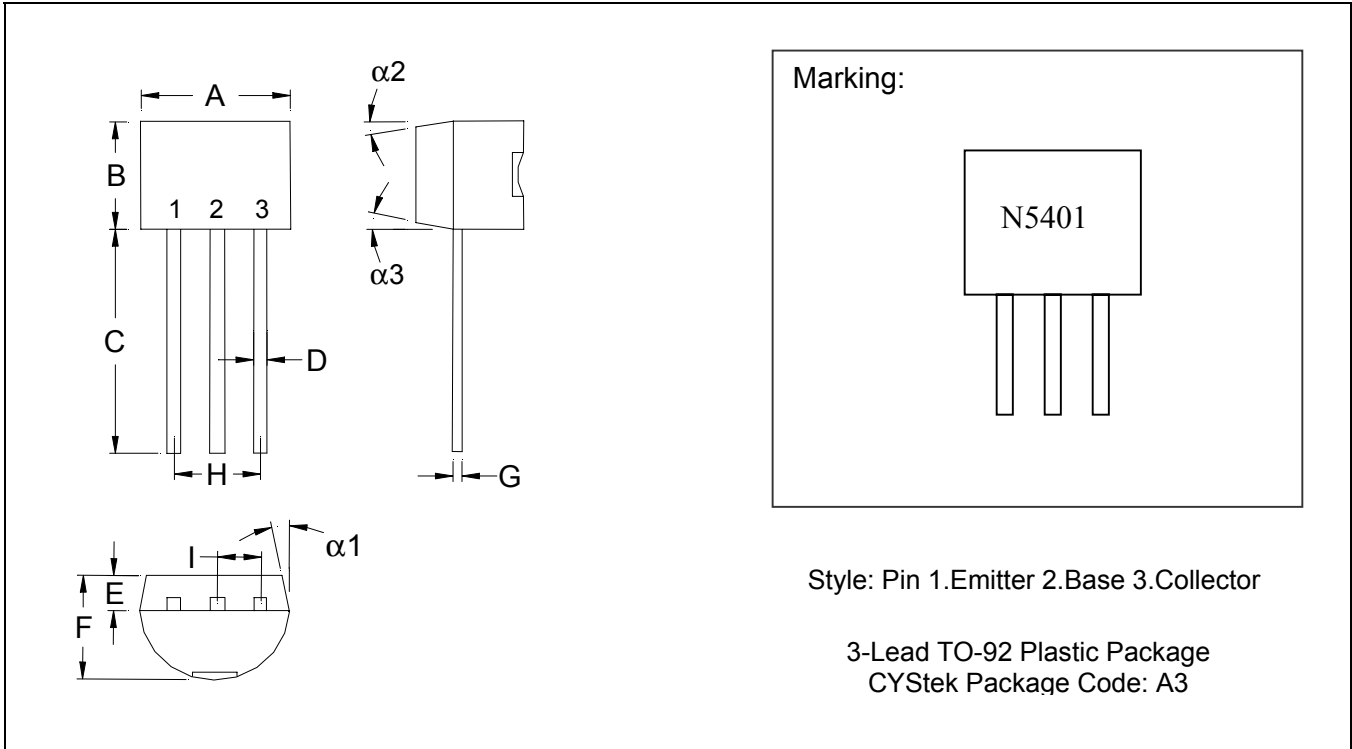

*: Typical

DIM	Inches		Millimeters		DIM	Inches		Millimeters	
	Min.	Max.	Min.	Max.		Min.	Max.	Min.	Max.
A	0.1704	0.1902	4.33	4.83	G	0.0142	0.0220	0.36	0.56
B	0.1704	0.1902	4.33	4.83	H	-	*0.1000	-	*2.54
C	0.5000	-	12.70	-	I	-	*0.0500	-	*1.27
D	0.0142	0.0220	0.36	0.56	$\alpha 1$	-	*5°	-	*5°
E	-	*0.0500	-	*1.27	$\alpha 2$	-	*2°	-	*2°
F	0.1323	0.1480	3.36	3.76	$\alpha 3$	-	*2°	-	*2°

Notes: 1. Controlling dimension: millimeters.
 2. Maximum lead thickness includes lead finish thickness, and minimum lead thickness is the minimum thickness of base material.
 3. If there is any question with packing specification or packing method, please contact your local CYStek sales office.

Material:

- Lead: 42 Alloy ; solder plating
- Mold Compound: Epoxy resin family, flammability solid burning class: UL94V-0

Important Notice:

- All rights are reserved. Reproduction in whole or in part is prohibited without the prior written approval of CYStek.
- CYStek reserves the right to make changes to its products without notice.
- CYStek **semiconductor products are not warranted to be suitable for use in Life-Support Applications, or systems.**
- CYStek assumes no liability for any consequence of customer product design, infringement of patents, or application assistance.