

FAST SWITCHING SCR**FEATURES**

- HIGH di/dt AND dV/dt RATINGS
- $t_q \leq 12\mu s$ AND $20\mu s$ FOLLOWING V_{DRM}/V_{RRM}
- HIGH STABILITY AND RELIABILITY

DESCRIPTION

The BTW30 Silicon Controlled Rectifier Family uses a high performance glass passivated technology.

This fast switching Silicon Controlled Rectifier Family is designed for high frequency power switching applications.

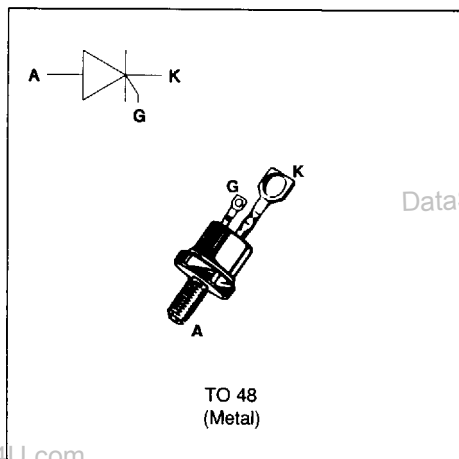
**ABSOLUTE RATINGS** (limiting values)

Symbol	Parameter		Value	Unit
$I_T(RMS)$	RMS on-state current (180° conduction angle)	$T_c=80^\circ C$	25	A
$I_T(AV)$	Average on-state current (180° conduction angle, single phase circuit)	$T_c=80^\circ C$	16	A
I_{TSM}	Non repetitive surge peak on-state current (T_j initial = $25^\circ C$)	$t_p=8.3$ ms	210	A
		$t_p=10$ ms	200	
I_2^t	I_2^t value	$t_p=10$ ms	200	A^2s
di/dt	Critical rate of rise of on-state current Gate supply : $I_G = 1$ A $di_G/dt = 10$ A/ μs		200	A/ μs
T_{stg} T_j	Storage and operating junction temperature range		- 40 to + 150	$^\circ C$
			- 40 to + 125	$^\circ C$
T_l	Maximum lead temperature for soldering during 10 s at 4.5 mm from case		230	$^\circ C$

Symbol	Parameter	BTW 30-				Unit
		600	800	1000	1200	
V_{DRM} V_{RRM}	Repetitive peak off-state voltage $T_j = 125^\circ C$	600	800	1000	1200	V

THERMAL RESISTANCES

Symbol	Parameter	Value	Unit
Rth (c-h)	Contact (case to heatsink)	0.4	°C/W
Rth (j-c) DC	Junction to case for DC	1.0	°C/W

GATE CHARACTERISTICS (maximum values)

PG (AV) = 1W PGM = 40W (tp = 20 μs) IFGM = 4A (tp = 20 μs) VFGM = 16V (tp = 20 μs) VRGM = 5 V.

ELECTRICAL CHARACTERISTICS

Symbol	Test Conditions			Value	Unit	
IGT	VD=12V (DC) RL=33Ω	TJ=25°C	MAX	200	mA	
VGT	VD=12V (DC) RL=33Ω	TJ=25°C	MAX	1.5	V	
VGD	VD=VDRM RL=3.3kΩ	TJ= 125°C	MIN	0.2	V	
tgt	VD=VDRM IG = 500mA dIG/dt = 3A/μs	TJ=25°C	TYP	1	μs	
IL	IG= 1.2 IGT	TJ=25°C	TYP	140	mA	
IH	IT= 500mA gate open	TJ=25°C	TYP	70	mA	
VTM	ITM= 50A tp= 380μs	TJ=25°C	MAX	3	V	
IDRM IRRM	VDRM Rated VRRM Rated	TJ=25°C	MAX	0.05	mA	
		TJ= 100°C		6		
dV/dt	Linear slope up to VD=67%VDRM gate open	TJ= 125°C	MIN	200	V/μs	
Tq	VD=67%VDRM ITM= 50A VR= 50V dITM/dt=10 A/μs dVD/dt=50V/μs	VRRM=600/800V	TJ= 125°C	MAX	12	μs
		VRRM=1000/1200V			20	

SINUSOIDAL CURRENT PULSE DATA

Fig. 1 : Energy per pulse for sinusoidal pulses.

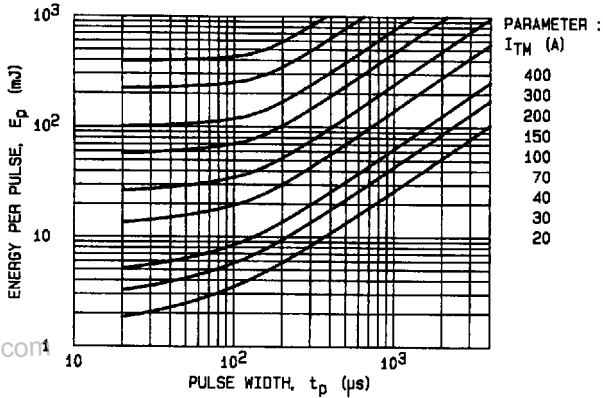
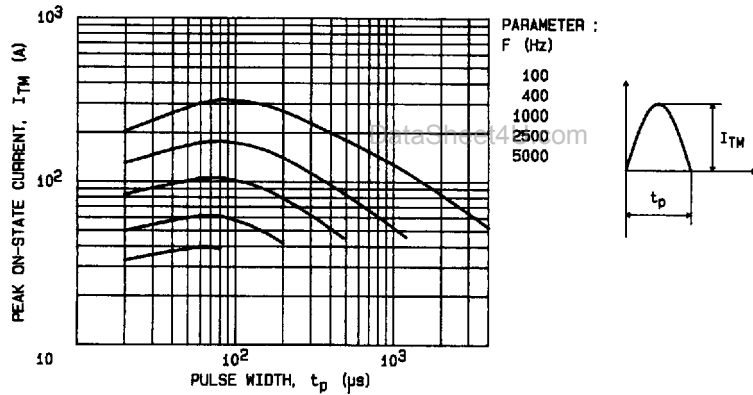
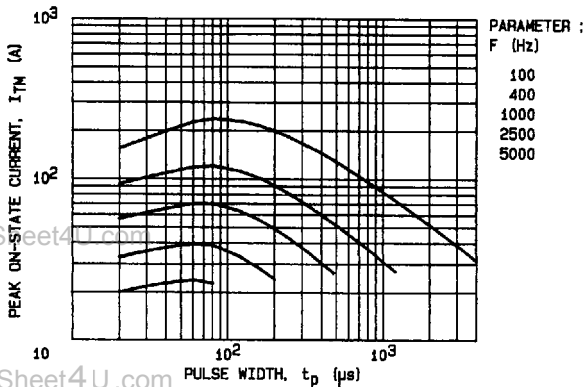
Fig. 2 : Maximum allowable peak on-state current versus pulse width for $T_c = 85^\circ\text{C}$.Fig. 3 : Maximum allowable peak on-state current versus pulse width for $T_c = 90^\circ\text{C}$.

NOTES :

1. $V_D = V_R = 600$ Volts.
2. R.C Snubber, $C = 0.1\ \mu\text{F}$,
 $R = 33\ \Omega$.

TRAPEZOIDAL CURRENT PULSE DATA

Fig.4 : Energy per pulse for trapezoidal pulses.

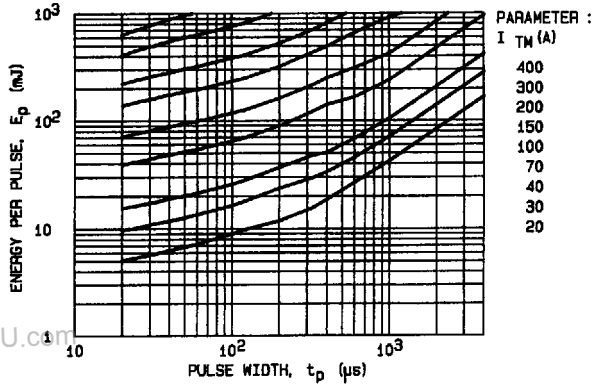
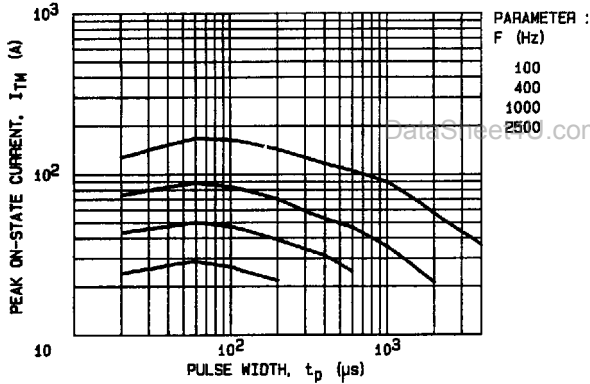
Fig.5 : Maximum allowable peak on-state current versus pulse width for $T_c = 85^\circ\text{C}$.

$$di/dt = 100 \text{ A}/\mu\text{s}$$

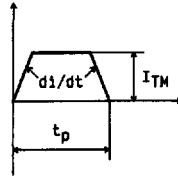
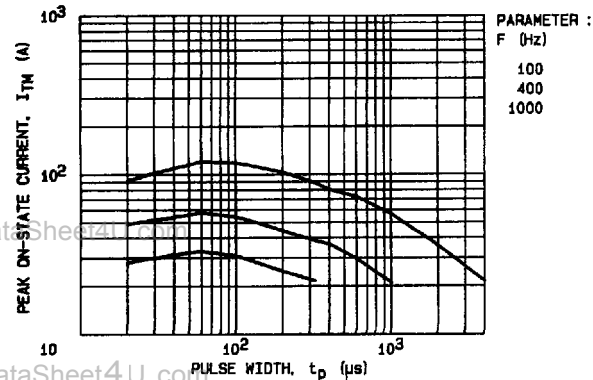
Fig.6 : Maximum allowable peak on-state current versus pulse width for $T_c = 90^\circ\text{C}$.

NOTES :

- $V_D = V_R = 800$ Volts.
- R.C Snubber, $C = 0.1 \mu\text{F}$,
 $R = 33 \Omega$.

Fig.7 : Non repetitive surge peak on-state current versus number of cycles.

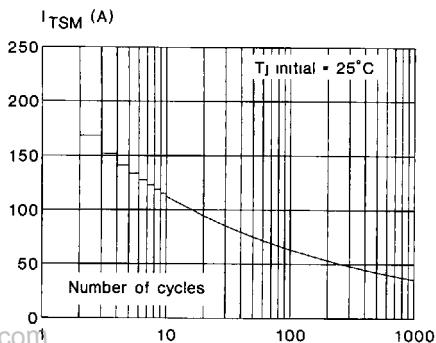

Fig.8 : Transient thermal impedance junction to ambient.

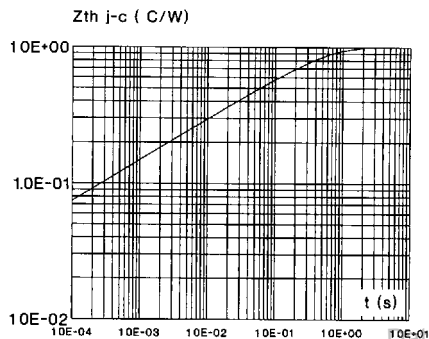

Fig.9 : Relative variation of gate trigger current and holding current versus junction temperature.

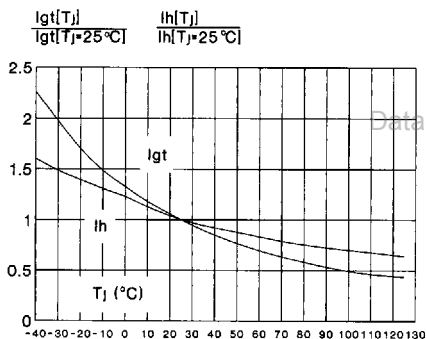

Fig.10 : Non repetitive surge peak on-state current for a sinusoidal pulse with width : $t \leq 10$ ms, and corresponding value of I^2t .

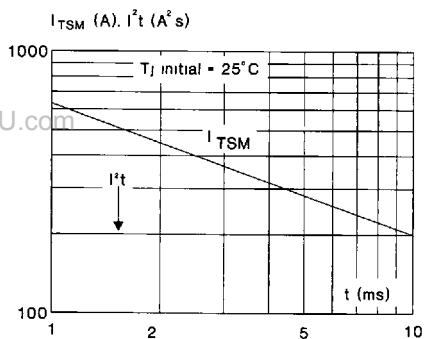
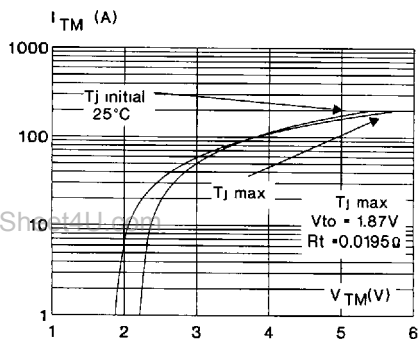
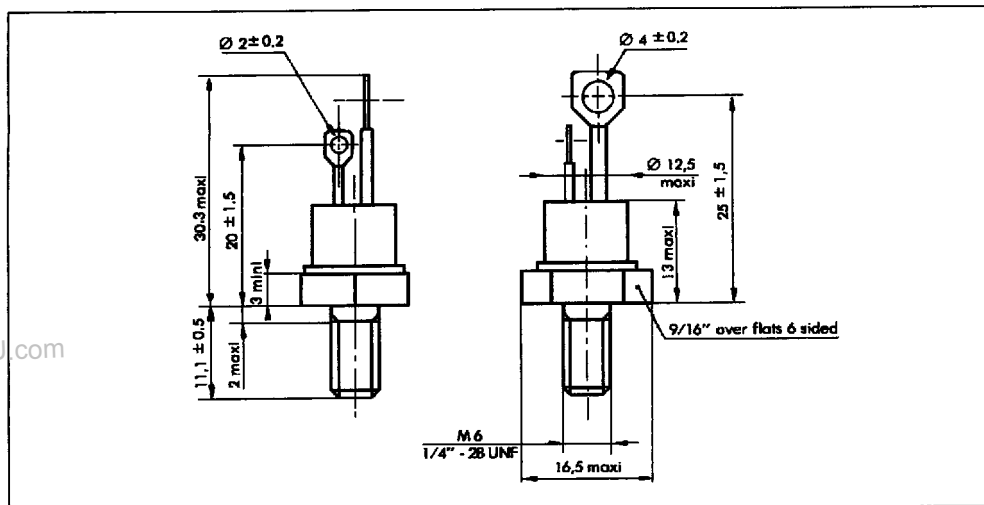

Fig11 : On-state characteristics (maximum values).



PACKAGE MECHANICAL DATA (in millimeters)

TO 48 Metal



Cooling method : A

Marking : type number

Weight : 13.5 g

Polarity : Anode (or A2) to case

Stud torque : 3.5 mAN min / 3.8 mAN max

DataSheet4U.com