

Microcontroller for simple-key remote controllers

BU2463/BU2464/BU2465/BU2466

The BU2463 series are four-bit, single-chip microcomputers on which all of the functions required for a remote control transmitter can be configured on a single chip, which can be used as a microcontroller for a remote control encoder.

These are ideal for keeping system sizes compact, keeping prices low, and building sophisticated functions.

●Applications

Remote control encoders

Specifications

| Series | BU2463 / BU2464 / BU2465 | BU2466 |
|-------------------------------|---------------------------|---------------------------|
| Program memory (ROM) (bytes) | 640 | 640 |
| Data memory (RAM) (bits) | 16×4 | 16×4 |
| Subroutine nesting levels | 2 | 2 |
| Instruction sets | 40 | 40 |
| Large-current output port | 1 | 1 |
| Input ports | 4 | 4 |
| Output ports | 8 | 6 |
| Instruction cycle (μ s) | 13.2 ($f_{osc}=455kHz$) | 13.2 ($f_{osc}=455kHz$) |
| Power supply voltage (V) typ. | 3 | 3 |

●Features

- 1) Program memory (ROM) of 640 bytes
- 2) Data memory (RAM) of 16×4 bits
- 3) 2 levels of subroutine nesting
- 4) 4-bit input ports (for key scanning)
- 5) 8-bit individual output ports (for key scanning)
- 6) Large-current output port (for remote control signals)
- 7) Clock frequency : 300kHz ~ 1MHz
- 8) Instruction cycle of 13.2 μ s (when $f_{osc} = 455kHz$)
- 9) HALT function (through internal instructions)
- 10) HALT cancel function using key input (mask option)
- 11) Internal carrier generator circuit for infrared remote control signals
- 12) Four carrier signal modes selectable (mask option)
- 13) Internal capacitor can be added for ceramic oscillation circuit (mask option)
- 14) Internal watchdog timer
- 15) Internal Power On Reset function

●Absolute maximum ratings (Ta=25°C)

| Parameter | Symbol | Limits | Unit |
|----------------------|------------------|---|------|
| Power supply voltage | V _{DD} | -0.3~6.0 | V |
| Power dissipation | P _d | 550*1 (BU2463) 600*2 (BU2464 / BU2465) 550*3 (BU2466) | mW |
| Storage temperature | T _{stg} | -55~+125 | °C |
| Input voltage | V _{IN} | -0.3~V _{DD} +0.3 | V |
| Output voltage | V _{OUT} | -0.3~V _{DD} +0.3 | V |

*1 Reduced by 5.5mW for each increase in Ta of 1°C over 25°C.

*2 Reduced by 6mW for each increase in Ta of 1°C over 25°C.

*3 Reduced by 5mW for each increase in Ta of 1°C over 25°C.

●Recommended operating conditions

| Parameter | Symbol | Limits | Unit |
|-----------------------------|-----------------|---------|------|
| Power supply voltage | V _{DD} | 2.0~4.0 | V |
| Operating temperature range | Topr | -25~+75 | °C |

●Block diagram

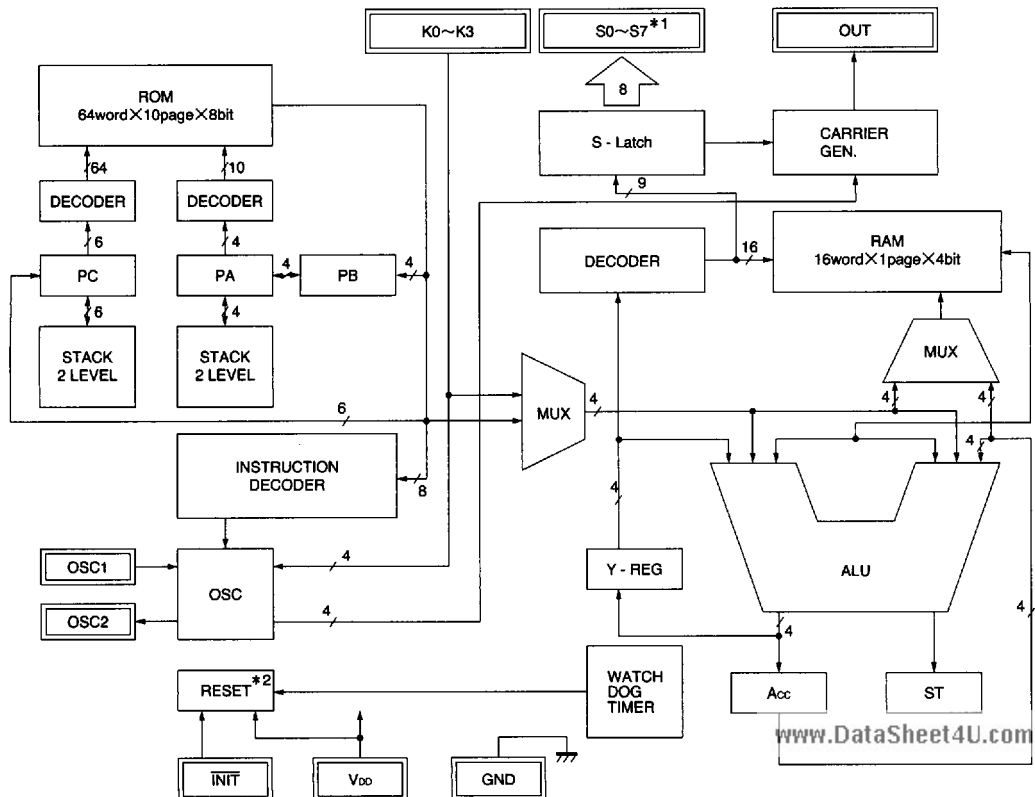

*1 The S4 and S5 port does not extend to the exterior on the BU2466.

*2 The BU2466 does not have a Power On Reset function.

● Pin assignments

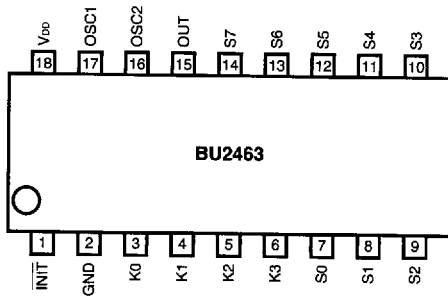

BU2463 pin layout

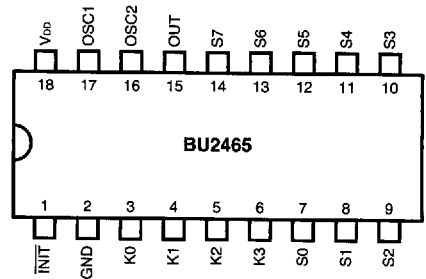

BU2465 pin layout

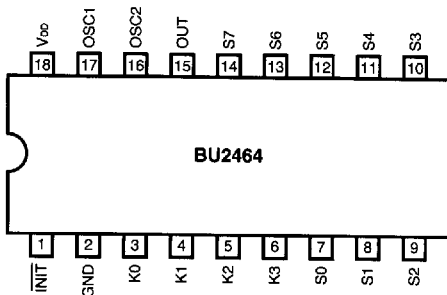

BU2464 pin layout

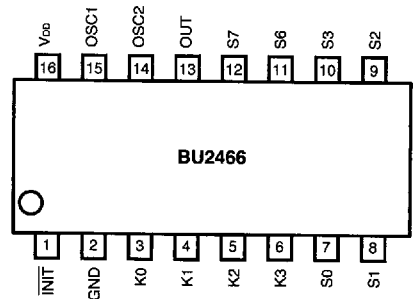

BU2466 pin layout

● Pin descriptions

| Pin name | I/O | Function |
|-----------------|--------|--|
| V _{DD} | — | Used to connect 2.0 V ~ 4.0 V power supply. |
| GND | — | Reference voltage for all inputs and outputs (0 V). |
| INIT | Input | Manual reset input. Setting this pin to LOW initializes the S output ports and OUT output ports to LOW and sets the ROM address to 0 page, 0 address. |
| K0~K3 | Input | 4-bit input ports. Internal pull-up resistance. A mask option can be used to select whether or not the HALT cancel function is to be effective for each individual bit (when the HALT function is effective, the HALT status is cancelled by setting this to LOW). |
| S0~S7 | Output | Each of these can be set and reset independently (or all at once). The output format is Nch open drain. * |
| OUT | Output | Remote control signal output port which can be used to drive large currents. The output format is CMOS output. The output HIGH current side can be used to drive large currents. |
| OSC1 | Input | OSC1 A ceramic resonator is connected between this pin and OSC2. There is internal feedback resistance between this pin and OSC2. |
| OSC2 | Output | OSC2 A ceramic resonator is connected between this pin and OSC1. |

Note: There is no S4 or S5 port on the BU2466.

● Input/output circuits

| Pin Name | I/O | I/O Circuit | Notes |
|--------------------------|--------|-------------|---|
| $\overline{\text{INIT}}$ | Input | | Hysteresis input Internal pull-up resistance About. 400 k Ω |
| K0~K3 | Input | | Internal MOS Tr for pull-up About. 120 k Ω |
| S0~S7 | Output | | Open drain output LOW on reset No S4 or S5 in the BU2466 |
| OUT | Output | | CMOS output LOW on reset Output HIGH current side can drive large currents |
| OSC1 | Input | | Internal MOS Tr for feedback Rf: about. 1 M Ω Internal damping resistance Rd: about. 6 k Ω (optional) Internal capacitors can be provided for oscillation C1: about. 100 pF C2: about. 100 pF |
| OSC2 | Output | | |

* Circled items are mask options.

●Electrical characteristics (Unless otherwise noted, Ta=25°C, VDD=3V)

| Parameter | Symbol | Min. | Typ. | Max. | Unit | Conditions |
|---------------------------------|--------------------|------|------|------|------|--|
| INIT input current (HIGH) | I _{IHT} | — | — | 1 | μA | V _I =V _{DD} |
| INIT input current (LOW) | I _{ILT} | -3 | -7.5 | -16 | μA | V _I =GND |
| K input current (HIGH) | I _{IHK} | — | — | 1 | μA | V _I =V _{DD} |
| K input current (LOW) | I _{ILK} | -9 | -25 | -50 | μA | V _I =GND |
| K input voltage (HIGH) | V _{IHK} | 2.1 | — | 3 | V | — |
| K input voltage (LOW) | V _{ILK} | 0 | — | 0.9 | V | — |
| INIT input voltage (HIGH) | V _{IHI} | 2.25 | — | 3 | V | — |
| INIT input voltage (LOW) | V _{ILI} | 0 | — | 0.75 | V | — |
| S output voltage (LOW) | V _{OLS} | — | 0.15 | 0.4 | V | I _{OL} =1mA |
| OUT output voltage (LOW) | V _{OLOT} | — | 0.15 | 0.4 | V | I _{OL} =100 μA |
| OUT output voltage (HIGH) | V _{OHOT} | 2.1 | 2.5 | — | V | I _{OH} =-8mA |
| OSC2 output voltage (LOW) | V _{OLOS} | — | 0.4 | 0.9 | V | I _{OL} =70 μA |
| OSC2 output voltage (HIGH) | V _{OHOS} | 2.1 | 2.5 | — | V | I _{OH} =-70 μA |
| S output leakage current | I _{LS} | — | — | 1 | μA | V _O = V _{DD} , output OFF |
| OSC1 feedback current | I _{OSC1} | 1 | 3 | 7 | μA | When V _{OSC1} = GND, V _{OSC2} = V _{DD} , in HALT mode |
| Static current consumption | I _{DBST} | — | — | 1 | μA | In HALT mode |
| Operating current consumption 1 | I _{DDOP1} | — | 0.3 | 1.0 | mA | f _{osc} =455kHz |
| Operating current consumption 2 | I _{DDOP2} | — | 0.25 | — | mA | External clock of 1 MHz |
| Operating frequency | f _{OSC} | 300 | — | 1000 | kHz | — |
| Oscillation capacitance 1 | C1 | — | 100 | — | pF | When using internal capacitor |
| Oscillation capacitance 2 | C2 | — | 100 | — | pF | When using internal capacitor |
| Calculation speed | | — | 30 | — | μs | f _{osc} =1MHz |

● Measurement circuits

Fig.1 ① Input current (HIGH) measurement circuit
② Input current (LOW) measurement circuit

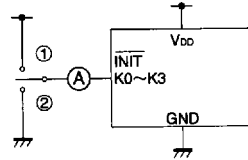

Fig. 2 ① S output voltage (LOW) measurement circuit
② OSC2 output voltage (LOW) measurement circuit
③ OUT output voltage (LOW) measurement circuit
(When measuring, Nch transistor should be on.)

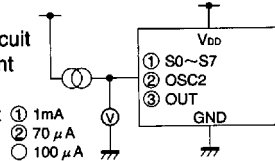

Fig. 3 ① OUT output voltage (HIGH) measurement circuit
② OSC2 output voltage (HIGH) measurement circuit
(When measuring, Pch transistor should be on.)

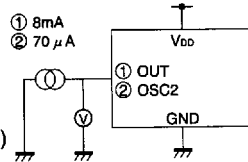

Fig. 4 S output leakage current measurement circuit
(When measuring, Nch transistor should be on.)

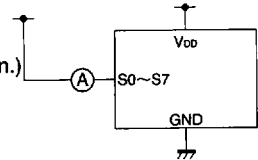

Fig. 5 OSC1 feedback current measurement circuit

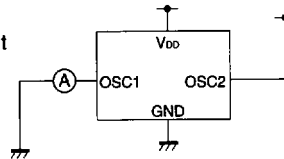

Fig. 6 Static current consumption measurement circuit
(Measurement in HALT mode, using HALT instruction to enter mode.)

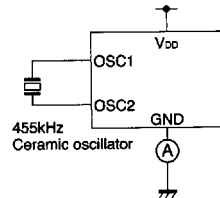
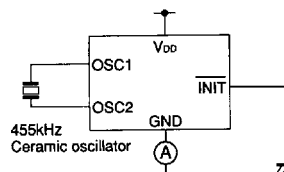

Fig.7 Operating current consumption measurement circuit



(Note) The BU2466 does not have S4 and S5 pins.

●Application example

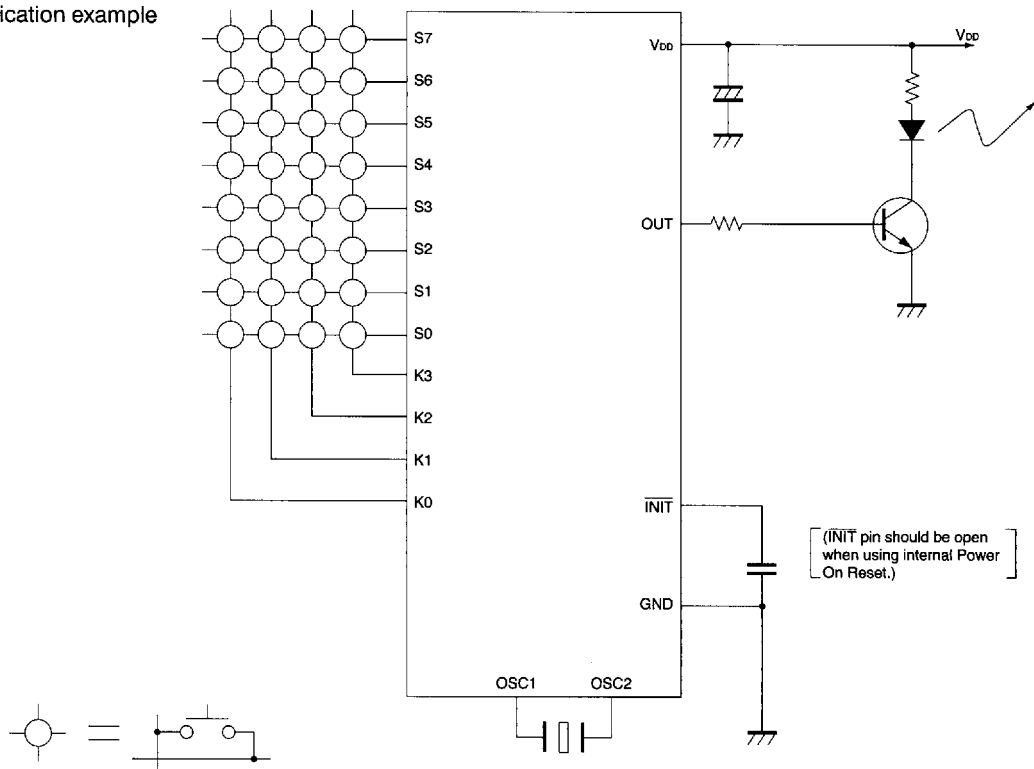

Fig. 8

Example: When using 32-key (8×4)

This circuit is an example that substantiates the function of the IC and not to guarantee the characteristics.

External constant and circuit must be considered carefully.

As the oscillation circuit constant must be determined by the make of the oscillator to be used.

Note: There are no S4 or S5 pins in the BU2466.

●Mask options

With the BU2463, BU2464, BU2465, and BU2466, the following options can be selected :

- 1) Carrier signal mode (A, B, C, D)
- 2) The watchdog timer can be reset (or not reset) using the OUT output signal.
- 3) The following input pins are equipped with a HALT cancel function : K0, K1, K2, K3.
- 4) An internal capacitor can be provided (or not) for a ceramic oscillation circuit.
- 5) Output states in HALT mode

S6 : LOW state (values prior to HALT state are retained)

S7 : LOW state (values prior to HALT state are retained)

●HALT function

The HALT state can be initiated by executing the HALT instruction. In the HALT state, the following apply :

- 1) Oscillation stops, enabling an extremely low current consumption.
- 2) The watchdog timer (WDT) is reset, and the S and OUT outputs go to LOW state.
- 3) All values other than the WDT, S output and OUT output retain the values in effect prior to the HALT state.

※However, the state of the S6 output and S7 output in the HALT mode can be selected using the mask options.

Ⓐ : Sets LOW state.

Ⓑ : The values in effect prior to the HALT state are maintained.

The HALT cancel function can be specified independently for each bit of the K inputs, using the mask options.

If even one of the K inputs has been set to LOW, the HALT state is cancelled.

If the HALT state is cancelled, the following occur :

- 1) The S output and OUT output values return to the values in effect prior to the HALT state.
- 2) In order to prevent operation before oscillation has

stabilized, a wait timer is activated, and normal operation is then initiated after 1024×6 effective clock pulses.

- 3) At the point where normal operation is resumed, the WDT begins to count again from 0. For K inputs equipped with the HALT cancel function, if a LOW state has been input, the HALT instruction has the same effect as the NOP instruction.

●Configuration

(1) Block diagram

1) Program memory (ROM)

An internal ROM of 640 words (64 words×10 pages×8 bits) for application software programs can be provided.

The scope of the program memory consists of the program counter PC ($A_0 \sim A_5$) and the page address register PA ($A_6 \sim A_9$), which are used to specify the address of the program register containing the next instruction (8 bits) to be executed.

The program memory is configured with one page consisting of 64 words, so that a maximum of 64 instructions can be stored on one page.

With evaluation chips, the ROM is attached externally, which makes it possible to carry out debugging and simulations of the pertinent system program. The program memory configuration is shown in Figure 9.

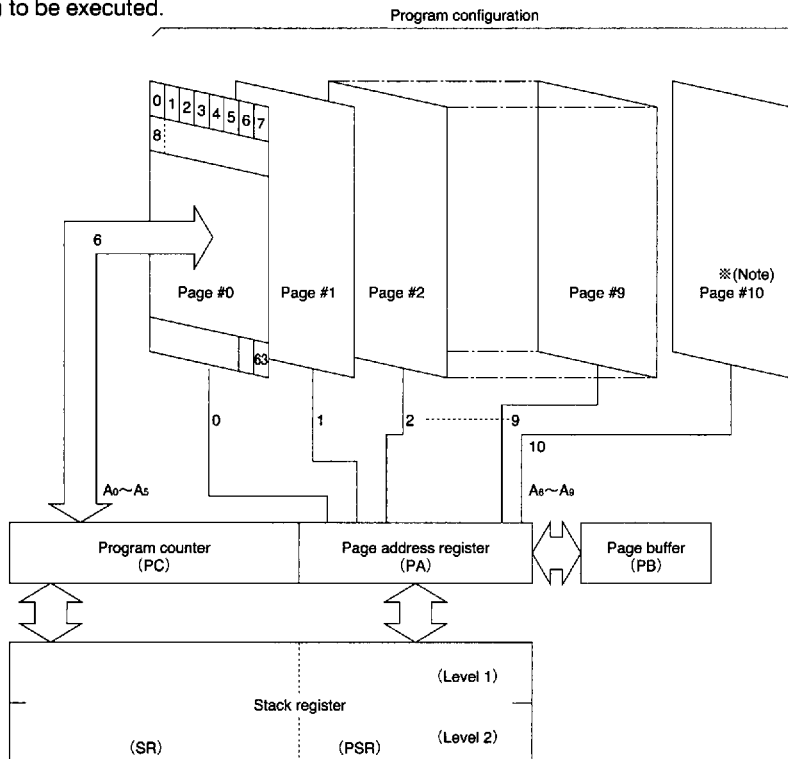

Fig. 9 Program memory configuration

※(Note) Page #10 cannot be used as a program memory, but it can be used as a delay timer function during programming.
(See →2-1-14 Delay timer function)

2) ROM address registers

The following registers are available to specify ROM addresses.

●Page address register (PA)

This contains the page numbers for the specified address in the ROM. The contents of the PA (4 bits) are decoded by a page decoder as one of 11 address lines.

●Page buffer register (PB)

New addresses are loaded into the PB, and are then shifted to the PA when the correct branch (BR) and subroutine call (CAL) are executed. The LPC instruction is used to load the PB.

●Program counter (PC)

This is used for word addresses on ROM pages. One instruction is selected by the page decoder from among the contents of the PC (6 bits).

●Stack register (SR)

This stores return word addresses in the Call Subroutine mode.

(1) Page address register and page buffer register

The range of 0 ~ 10 pages in the ROM is defined by latching the four bits specifying the ROM page address.

The page address register differs from the program counter in that normally it does not change. As long as the Page Change instruction is not executed, the program continues to remain on the same page.

To change the page address requires a two-step operation : ① write the page to which the program execution is to jump in the page buffer (execute the LPC instruction), and ② execute the BR or CAL instruction.

This is necessary because the instruction code consists of 8 bits, and the page and word cannot be specified at the same time.

If the return instruction (RTN) from a subroutine in a subroutine called from another page is executed, the page address is changed at the same time.

(2) Program counter

The program counter is a 6-bit binary counter which is incremented each time an instruction is fetched, and specifies the address on the current page of the ROM containing the instruction which has to be executed next.

To facilitate programming, the program counter is reset to a location of zero each time the power supply is turned on, and the page address is set to 0. Next, the program counter specifies the next ROM address, us-

ing a random sequence. When the BR, CAL, and RTN instructions are decoded (in other words, when the MSB of the eight bits, which is $I_0 = 1$, is detected), the switches are turned off between the various stages, and the address is not updated. Instead, for the BR and CAL instructions, the address data is read from the instruction operand ($I_2 \sim I_7$), and for the RTN instruction, the address is read from the stack register (Level 1).

(3) Stack register

The stack register, which retains the return address when a subroutine is executed, is equipped with three levels for both the program counter (6 bits) and the page address register (4 bits). This enables subroutine nesting at two levels.

3) Data memory (RAM)

An internal RAM enables up to 16 words×4 bits to be stored.

The scope of the entire data memory is specified indirectly by the data pointer Y, with the word being specified by the four bits of the Y register.

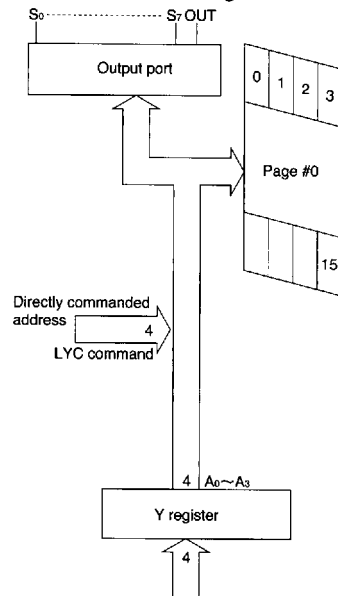

Fig. 10 Data memory configuration

4) Y register (Y)

The Y register consists of four bits. It acts as a data pointer or a general-purpose register.

The Y register specifies the address of the page in the data memory, and at the same time is used to specify the output port. It can also be handled as a general-purpose register in the program.

5) Accumulator (Acc)

This is a 4-bit register used when carrying out calculations. Data and data resulting from calculations are stored in this register.

6) Arithmetic logic unit (ALU)

The arithmetic logic unit is configured of the addition and comparison units, which are connected in a 4-bit series, and a status logic (flag).

(1) Calculation circuit (ALU)

The basic function of the addition / comparison unit is to carry out all addition and comparison operations. Subtraction is handled by reversing the Acc output [Acc + 1] and creating a complement.

(2) Status logic

The status logic creates the ST, which is the flag that controls the program flow. If the calculation overflow and the two inputs are not equivalent, this flag is issued when the specified instruction is executed.

7) Instruction decoder

Of the 40 types of instructions provided in the BU2463 series, 29 types are converted by the instruction decoding PLA into 16 types of micro-instructions, and when an instruction is executed, the instruction decoder handles operations such as connecting the data buses. Eight of the remaining 11 types of instructions, excluding the BR, CAL, and RTN instructions, are decoded by a decoder configured of only an AND matrix. This method works because the execution of these types of instructions does not require a large number

of micro-instructions, and they operate in fairly isolated locations where they are not involved with other instructions. If the instruction is the BR, CAL, or RTN instruction, the following instruction is invalid. Therefore, these three instructions are not decoded using a decoder, but are decoded and executed directly by the hardware logic as the instruction code is read from the ROM. This avoids subsequent instructions being invalidated, so that the jump in program execution can be made to the pertinent address.

8) Input/output circuits

The $K_0 \sim K_3$ ports are 4-bit input ports, and are pulled up by an MOS Tr resistance.

The $S_0 \sim S_7$ ports are output ports which can be set and reset independently. The output configuration is an Nch open drain circuit.

The OUT port can be used to drive large currents, and is a CMOS circuit (large current on the HIGH side).

9) State counter (SC)

Figure 11 shows the basic machine cycle timing. All instructions consist of one byte, with the same execution time.

Execution of one instruction consists of six clock pulses for the reading (Fetch) cycle and six clock pulses for the execution (Execute) cycle, for a total of 12 pulses, but in actuality, the two cycles overlap and are executed at the same time, so that it appears that the cycle execution (one machine cycle) is being completed in six clock pulses.

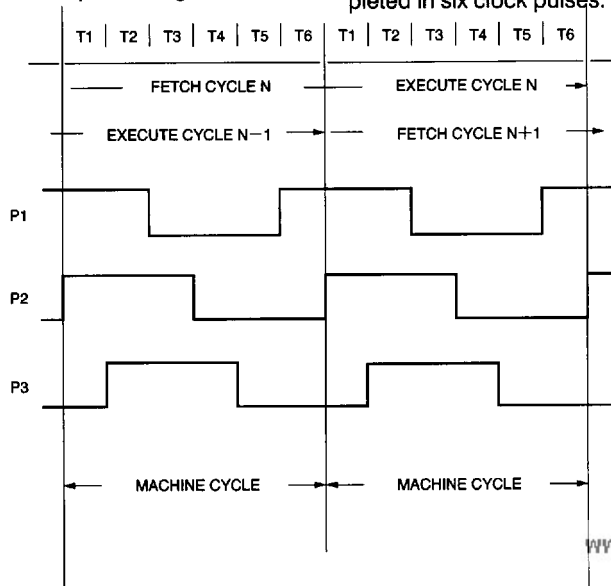

Fig. 11 Basic timing chart

Execution of one instruction consists of six clock pulses for the reading (Fetch) cycle and six clock pulses for the execution (Execute) cycle, for a total of 12 pulses, but in actuality, the two cycles overlap and are executed at the same time, so that it appears that the cycle execution (one machine cycle) is being completed in six clock pulses.

The exceptions to the execution time are the BR, CAL, and RTN instructions. With these three instructions, the subsequent command is invalidated because of the time required to change the address sequence. Therefore, the instruction is read in advance, so that execution can be completed within the fetch cycle.

10) Clock generator

The BU2463 series has an internal clock generator. The oscillation circuit can be configured by attaching an external ceramic resonator (if an optional internal oscillation capacitor is used).

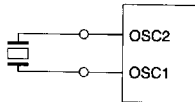

Fig. 12

* Depending on the resonator, an external capacitor may be necessary. Please consult the pertinent manufacturer for recommended values.

11) Reset function

Two reset functions are available to initialize the CPU. When the CPU is initialized, the program counter executes instructions from 0 page, 0 address.

(1) Reset through an external pin

A reset can be executed by setting the INIT pin to LOW, which is done by specifying an interval of four or more machine cycles. (One machine cycle = $1 / f_{osc} \times 6$)

If a reset is executed by turning on the power supply, a capacitor can be connected between the INIT pin and the GND and an integrated circuit configured with the internal pull-up resistance (approximately 400kΩ). This generates a reset pulse when the power supply is turned on.

However, this method is effective only when a valid reset pulse is input while the power supply voltage is within the operating voltage range and the clock oscillation has stabilized.

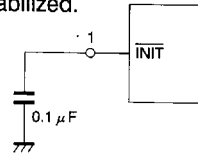

Fig. 13

* The capacitor value may need to be changed depending on the rise time of the power supply (this circuit example shows a power supply rise time of 10 ms or less).

(2) Reset using the internal Power On Reset circuit
The Power On Reset circuit is valid when the following conditions are satisfied. In this case, the external capacitor on the INIT pin may be omitted. (BU2463 / BU2466 only)

The BU2466 does not have this internal circuit. A reset should be initiated using an external pin.

(V_{DD}=3V, f_{osc}=455kHz)

| Parameter | Symbol | Min. | Typ. | Max. | Unit | Condition |
|-----------------------------|-----------------|------|------|------|------|-----------------------|
| Power supply rise time | t _{r1} | — | — | 1 | ms | |
| Rise time when interrupted | t _{r2} | — | — | 1 | ms | V _{Min.} =1V |
| Power supply interrupt time | t _w | 5 | — | — | ms | |

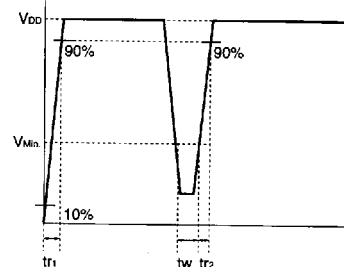

Fig. 14

12) Carrier generator

The carrier signal output from the OUT output port can be selected from among those listed in the table below, using a mask option.

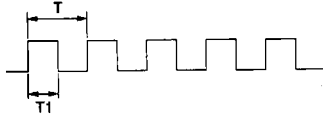

Fig. 15

| Option | OUToutput signal |
|--------|--|
| A | $T=1 / f_{CAR}=12 / f_{osc}$ $T1 / T=1 / 2$ |
| B | $T=1 / f_{CAR}=12 / f_{osc}$ $T1 / T=1 / 3$ |
| C | $T=1 / f_{CAR}=8 / f_{osc}$ $T1 / T=1 / 2$ |
| D | No carrier output (same operation as S0 ~ S7) |

* f_{osc} : Oscillation frequency, f_{CAR} : Carrier frequency

13) Watchdog timer

The watchdog timer is configured of a 14-bit binary counter, and a clock signal of $f_{osc} / 6$ is input as the initial stage input. When this counter overflows, an internal reset signal is issued automatically, and the internal circuits are initialized. The detection time is set to $6 \times 12^{13} / f_{osc}$ (108.0ms when $f_{osc} = 455\text{kHz}$). Normally, this counter has to be reset prior to the overflow of the binary counter, and in addition to the WDTR instruction, a mask option makes it possible to use the OUT output signal to do this (when Y - reg = 8 and the SEO instruction is executed). A reset is carried out forcibly in the HALT state, and the counter resumes when the HALT state has been cancelled.

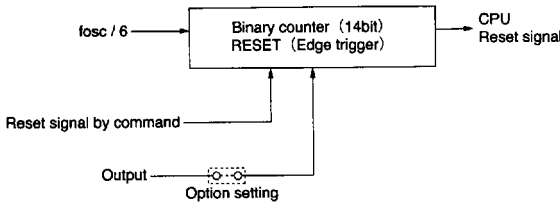

Fig. 16

14) Delay timer function

The tenth page of the ROM does not contain a program ROM, but can be used as a delay timer by specifying the ROM area in the program.

Setting the page buffer to 10 in the program and branching to an appropriate address using a subroutine call (CAL instruction) or a branch (BR instruction) in the subroutine enables a delay time of up to 64 machine cycles to be produced.

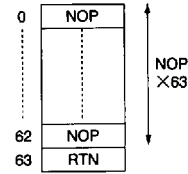

Fig. 17

● Instruction systems

(1) Abbreviations

Rohm's BU2463 series of 4-bit single-chip microcomputers has 40 types of basic instructions. These instructions are configured of the mnemonic abbreviations listed below.

1) Instructions related to operation

- L- : Load
- X- : Exchange
- SE- : Set
- RE- : Reset
- D- : Decrement
- I- : Increment
- CL- : Clear
- NEG- : Negate
- A- : Add
- S- : Subtract
- BR : Branch
- CAL : Call
- RTN : Return
- T- : Test
- E- : Exclusive

2) Instructions related to constants

C [I (C)] : Immediate Z : Zero

3) Instructions related to status

The status is set to "1" under the following conditions.

- aNEb : $a \neq b$
- aLEb : $a \leq b$
- C : Carryout on A or I
- N : Not Borrow Out on S or D
- Z : Zero on NEG
- TM : 1

4) Instructions related to architecture block

- P : Page Buffer Register
- A : Accumulator Register
- Y : Y-Register
- M : RAM
- $K_0 \sim K_3$: Input
- $S_0 \sim S_7$, OUT : Output

(2) Instruction formats

All instructions are composed of eight bits, including two fields : an operation code and an operand. Formats are classified by the type of operand.

1) Format I

This format has no operand; all of the 8-bits are operation codes.

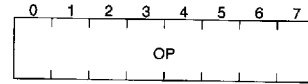

2) Format II

This format consists of 2-bits of operands and 6-bits of operation codes.

The 2-bits of operands are used to specify the bit address in the RAM word.

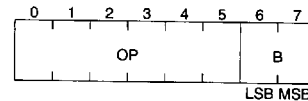

3) Format III

This format consists of 4-bits of operands and 4-bits of operation codes.

The 4-bits of operands are used to specify the constant loaded into the RAM, the word address in the Y register, the comparison values for the comparison instruction, or the ROM page address.

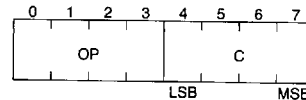

4) Format IV

This format consists of 6-bits of operands and 2-bits of operation codes.

The 6-bits of operands are used to specify the ROM address.

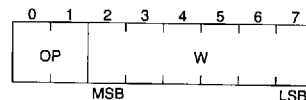

● Command functions

The BU2463 series is equipped with the 40 types of general commands shown below.

| | Class. | Mnemonic | Function | ST*1 | Instruction code | |
|----|---------------------------------------|----------|---|------|------------------|-------|
| 1 | Transfer from one register to another | LYA | $Y \leftarrow \text{Acc}$ | S | 0010 | 0100 |
| 2 | | LAY | $\text{Acc} \leftarrow Y$ | S | 0010 | 0011 |
| 3 | | CLA | $\text{Acc} \leftarrow 0$ | S | 0010 | 1111 |
| 4 | Transfer from register to RAM | LMA | $M(Y) \leftarrow \text{Acc}$ | S | 0000 | 0011 |
| 5 | | LMAIY | $M(Y) \leftarrow \text{Acc}, Y \leftarrow Y+1$ | S | 0010 | 0000 |
| 6 | | LMAZA | $M(Y) \leftarrow \text{Acc}, \text{Acc} \leftarrow 0$ | S | 0000 | 0100 |
| 7 | Transfer from RAM to register | LYM | $Y \leftarrow M(Y)$ | S | 0010 | 0010 |
| 8 | | LAM | $\text{Acc} \leftarrow M(Y)$ | S | 0010 | 0001 |
| 9 | | XMA | $\text{Acc} \leftarrow M(Y)$ | S | 0010 | 1110 |
| 10 | Set constant | LYC | $Y \leftarrow I(C)$ | S | 0100 | (C) |
| 11 | | LMCIY | $M(Y) \leftarrow I(C), Y \leftarrow Y+1$ | S | 0110 | (C) |
| 12 | RAM bit operation | SEM | $M(Y, B) \leftarrow 1$ | S | 0011 | 00(B) |
| 13 | | REM | $M(Y, B) \leftarrow 0$ | S | 0011 | 01(B) |
| 14 | | TM | When $M(Y, B) = 1$, set status | E | 0011 | 10(B) |
| 15 | RAM address specification | BR | When $ST = 1$, branch to specified address | S | 10 (W) | |
| 16 | | CAL | When $ST = 1$, call subroutine of specified address | S | 11 (W) | |
| 17 | | RTN | Return from subroutine to main routine | S | 0000 | 1111 |
| 18 | | LPC | $PB \leftarrow I(C)$ | S | 0001 | (C) |
| 19 | Calculation | AMAAC | $\text{Acc} \leftarrow \text{Acc} + M(Y)$ | C | 0010 | 0101 |
| 20 | | SAMAN | $\text{Acc} \leftarrow M(Y) - \text{Acc}$ | B | 0010 | 0111 |
| 21 | | IMAC | $\text{Acc} \leftarrow M(Y) + 1$ | C | 0010 | 1000 |
| 22 | | DMAN | $\text{Acc} \leftarrow M(Y) - 1$ | B | 0010 | 1010 |
| 23 | | IA | $\text{Acc} \leftarrow \text{Acc} + 1$ | S | 0000 | 1110 |
| 24 | | IYC | $Y \leftarrow Y + 1$ | C | 0010 | 1011 |
| 25 | | DAN | $\text{Acc} \leftarrow \text{Acc} - 1$ | B | 0000 | 0111 |
| 26 | | DYN | $Y \leftarrow Y - 1$ | B | 0010 | 1100 |
| 27 | | EMAA | $\text{Acc} \leftarrow M(Y) \oplus \text{Acc}$ | S | 0000 | 0001 |
| 28 | | NEGAZ | $\text{Acc} \leftarrow \bar{\text{Acc}} + 1$ | Z | 0010 | 1101 |
| 29 | Comparison | ALEM | When $\text{Acc} \leq M(Y)$, set status | E | 0010 | 1001 |
| 30 | | ALEC | When $\text{Acc} \leq I(C)$, set status | E | 0111 | (C) |
| 31 | | MNEZ | If $M(Y)$ is not equal to 0, set status | N | 0010 | 0110 |
| 32 | | YNEA | If Y is not equal to Acc , set status | N | 0000 | 0010 |
| 33 | | YNEC | If Y is not equal to $I(C)$, set status | N | 0101 | (C) |
| 34 | Input | KNEZ | If $K0 \sim K3$ is not equal to 0, set status | N | 0000 | 1001 |
| 35 | | LAK | $\text{Acc} \leftarrow K0 \sim K3$ | S | 0000 | 1000 |
| 36 | Output | SEO | $S(Y) \leftarrow 1 * 2$ | S | 0000 | 1101 |
| 37 | | REO | $S(Y) \leftarrow 0 * 2$ | S | 0000 | 1100 |
| 38 | Other | WDTR | Watch Dog Timer Reset | S | 0000 | 0001 |
| 39 | | HALT | Halt operation | S | 0000 | 0110 |
| 40 | | NOP | No operation | S | 0000 | 0000 |

* 1 ST : Indicates a condition for which the status (ST) changes, with the respective meanings noted below.

S : The status is set unconditionally when the instruction is executed.

C : The status is set if a carry or borrow condition occurs in the calculation results.

B : The status is set if a borrow condition does not occur in the calculation results.

E : The status is set if the result of a comparison is true.

N : The status is set if the result of a comparison is false.

Z : The status is set if the result of the calculation is zero.

* 2 The following are carried out based on the contents of the Y register.

BU2463 / BU2464 / BU2465

| Y register value | Operation |
|------------------|---|
| 0~7 | SEO instruction: S (Y) ← 1 (High-Z) REO instruction: S (Y) ← 0 |
| 8 | SEO instruction: The OUT output pin alternates repeatedly between HIGH and LOW, at the carrier frequency. (Option D: OUT ← 1) REO instruction: OUT ← 0 |
| 9 | SEO instruction: S ₀ ~ S ₇ ← 1 (High-Z) REO instruction: S ₀ ~ S ₇ ← 0 |
| 10~15 | No operation |

BU2466

| Y register value | Operation |
|------------------|---|
| 0~3, 6, 7 | SEO instruction: S (Y) ← 1 (High-Z) REO instruction: S (Y) ← 0 |
| 8 | SEO instruction: The OUT output pin alternates repeatedly between HIGH and LOW, at the carrier frequency. (Option D: OUT ← 1) REO instruction: OUT ← 0 |
| 9 | SEO instruction: S ₀ ~ S ₇ ← 1 (High-Z) REO instruction: S ₀ ~ S ₇ ← 0 |
| 4, 5, 10~15 | No operation |

●Notes about the instruction system

The following describes each of the 40 types of basic instructions in the BU2463 series, in greater detail.

(1) Notation format

Descriptions are noted using the mnemonic abbreviations listed in the "Instruction Functions" table at the beginning of the instruction. The basic items noted below are indicated to facilitate understanding, with additional notes concerning functions and other information.

●Notation format

Item

- ①Naming : Full name of mnemonic
- ②Binary operation code : Displayed in diagram
- ③Status : Check of status functions
- ④Format : Type of instruction format (I to IV)
- ⑤Operand : Omitted for Format I instructions
- ⑥Function : Description of function

(2) Descriptions of instructions

1) LYA

Naming : Load Y - Register from Accumulator

Binary operating code :

| | | | | | | | |
|---|---|---|---|---|---|---|---|
| 0 | 1 | 2 | 3 | 4 | 5 | 6 | 7 |
| 0 | 0 | 1 | 0 | 0 | 1 | 0 | 0 |

Status : Set

Format : I

Function : $Y \leftarrow Acc$

〈Description〉 The contents of the accumulator are transferred unconditionally to the Y register. The contents of the accumulator do not change.

2) LAY

Naming : Load Accumulator from Y - Register

Binary operating code :

| | | | | | | | |
|---|---|---|---|---|---|---|---|
| 0 | 1 | 2 | 3 | 4 | 5 | 6 | 7 |
| 0 | 0 | 1 | 0 | 0 | 0 | 1 | 1 |

Status : Set

Format : I

Function : $A \leftarrow Y$

〈Description〉 The four bits of the Y register are transferred unconditionally to the accumulator. The contents of the Y register do not change.

3) CLA

Naming : Clear Accumulator

Binary operating code :

| | | | | | | | |
|---|---|---|---|---|---|---|---|
| 0 | 1 | 2 | 3 | 4 | 5 | 6 | 7 |
| 0 | 0 | 1 | 0 | 1 | 1 | 1 | 1 |

Status : Set

Format : I

Function : $Acc \leftarrow 0$

〈Description〉 The contents of the accumulator are set unconditionally to 0.

4) LMA

Naming : Load Memory from Accumulator

Binary operating code :

| | | | | | | | |
|---|---|---|---|---|---|---|---|
| 0 | 1 | 2 | 3 | 4 | 5 | 6 | 7 |
| 0 | 0 | 0 | 0 | 0 | 0 | 1 | 1 |

Status : Set

Format : I

Function : $M(Y) \leftarrow Acc$

〈Description〉 The 4-bit contents of the accumulator are accumulated in the memory (RAM) location specified by the Y register. The contents of the accumulator do not change.

5) LMAIY

Naming : Load Memory from Accumulator and Increment Y-Register

Binary operating code :

| | | | | | | | |
|---|---|---|---|---|---|---|---|
| 0 | 1 | 2 | 3 | 4 | 5 | 6 | 7 |
| 0 | 0 | 1 | 0 | 0 | 0 | 0 | 0 |

Status : Set

Format : I

Function : $M(Y) \leftarrow Acc$ $Y \leftarrow Y + 1$

〈Objective〉 The Y register continuously addresses the pages of the 16 RAM words, and the addressed word is set as the accumulator value.

〈Description〉 The contents of the accumulator are accumulated in the RAM location addressed by Y register.

Next, the contents of the Y register are incremented by one. The contents of the

6) LMAZA

Naming : Load Memory from Accumulator and Load Accumulator Zero

Binary operating code :

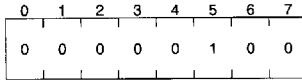

Status : Set

Format : I

Function : $M(Y) \leftarrow Acc$ $Acc \leftarrow 0$

〈Description〉 The contents of the accumulator are accumulated in the RAM location addressed by the Y register. The contents of the accumulator are then cleared to zero.

7) LYM

Naming : Load Y-Register from Memory

Binary operating code :

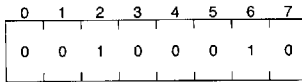

Status : Set

Format : I

Function : $Y \leftarrow M(Y)$

〈Description〉 The contents of the RAM location addressed by the Y register are loaded to the register. The contents of the memory do not change.

8) LAM

Naming : Load Accumulator from Memory

Binary operating code :

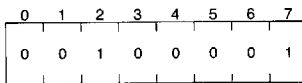

Status : Set

Format : I

Function : $Acc \leftarrow M(Y)$

〈Description〉 The contents of the RAM location addressed by the Y register are loaded to the accumulator. The contents of the memory do not change.

9) XMA

Naming : Exchange Memory and Accumulator

Binary operating code :

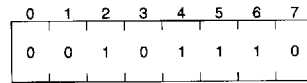

Status : Set

Format : I

Function : $M(Y) \leftrightarrow Acc$

〈Description〉 The contents of the memory addressed by the Y register are exchanged with the contents of the accumulator. For example, in order to carry out a calculation, this instruction can be used to read the memory words in the accumulator and save the current accumulator contents to the RAM. The contents can then be returned to the accumulator at the next XMA instruction.

10) LYC

Naming : Load Y-Register from Immediate

Binary operating code :

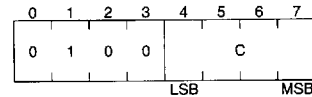

Status : Set

Format : III

Operand : Constant $0 \leq I(C) \leq 15$

Function : $Y \leftarrow I(C)$

〈Objective〉 This loads a constant to the Y register. In an ordinary usage example, Y is set in a specified RAM word address, an address for a selected output line is specified, or carrier signal to be output from the OUT output port is specified, by setting Y. It can also be used to initialize the Y register for loop control.

〈Description〉 A 4-bit value is transferred from the C field of the instruction to the Y register.

11) LMCYI

Naming : Load Memory from Immediate and Increment Y-Register

Binary operating code :

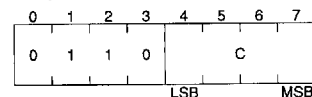

Status : Set

Format : III

Operand : Constant $0 \leq I(C) \leq 15$

Function : $M(Y) \leftarrow I(C)$, $Y \leftarrow Y + 1$

〈Description〉 A 4-bit value is transferred from the C field of the instruction and accumulated in the RAM location addressed by the Y register. Next, the contents of the Y register are incremented by 1.

12) SEM

Naming : Set Memory Bit

Binary operating code :

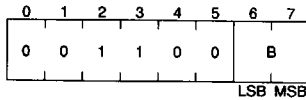

Status : Set

Format : II

Operand : Bit address $0 \leq I (B) \leq 3$

Function : $M (Y, B) \leftarrow 1$

〈Description〉 In accordance with the selection of the B field of the operand, the first bit of the 4 bits is set in the addressed RAM memory as a logic of 1, depending on the contents of the Y register.

13) REM

Naming : Reset Memory Bit

Binary operating code :

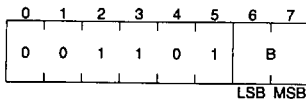

Status : Set

Format : II

Operand : Bit address $0 \leq I (B) \leq 3$

Function : $M (Y, B) \leftarrow 0$

〈Description〉 In accordance with the selection of the B field of the instruction, the first bit of the 4 bits is set in the addressed RAM memory as a logic of 0, depending on the contents of the Y register.

14) TM

Naming : Test Memory Bit

Binary operating code :

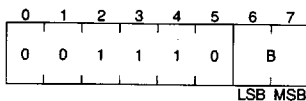

Status : To status of comparison results

Format : II

Operand : Bit address $0 \leq I (B) \leq 3$

Function : $M (Y, B) \leftarrow 1 ?$

$ST \leftarrow 1$ (when $M (Y, B) = 1$)

$ST \leftarrow 0$ (when $M (Y, B) = 0$)

〈Objective〉 This tests to see whether the logic of the selected memory bit is 1, and sets the status based on the result of the test.

15) BR

Naming : Branch on status 1

Binary operating code :

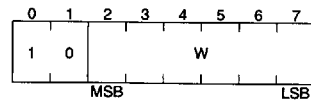

Status : Sets the status after executing the instruction, conditionally, depending on the status

Format : IV

Operand : Branch address (W)

Function :

If $ST = 1, PA \leftarrow PB, PC \leftarrow I (W)$

If $ST = 0, PC \leftarrow PC + 1, ST \leftarrow 1$

Note: In actuality, PC is a pseudo-random counter which specifies the next address in a fixed sequence.

〈Objective〉 Depending on the program, this can be used to change the order in which instructions are executed in a normally sequential program. The branch is conditional, based on the status of the results of executing the instruction.

〈Description〉

● This branching instruction is normally conditional, based on the status.

① If the status is "Reset" (the logic is 0), the next sequential instruction is executed, rather than branching being carried out.

② If the status is "Set" (the logic is "1"), the program is executed based on the following types of action.

● There are two types of branching, long and short. Short branching is used if the address is on the current page, and long branching is used if the address is on a different RAM page. The type of branching carried out is determined by the contents of the PB register. In order to execute long branching, the contents of the PB register must be modified with the desired page address, and this is done using the Load PB Register (LPC) instruction.

16) CAL

Naming : Subroutine Call on status 1

Binary operating code :

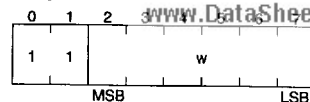

Status : Sets the status after executing the instruction, conditionally, depending on the status

Format : IV

Operand : Subroutine code less I (W)

Function :

If ST = 1, PC ← I (W) PA ← PB
 R1 ← PC + 1 PSR1 ← PA
 SR2 ← SR1 PSR2 ← PSR1
 If ST = 0, PC ← PC + 1 PB ← PA
 ST ← 1

Note: In actuality, PC has a pseudo-random counter in relation to the next instruction.

〈Description〉

● In the program, control can be shifted between common subroutines. The loaded instruction retains the return address, so subroutines can be called out from various locations throughout the program, and the Call Return instruction (RTN) can be used in the subroutine to return execution correctly to the loaded address. Loading of addresses and instructions is normally carried out conditionally, based on the status.

- ① If the status is "Reset", loading does not take place.
 - ② If the status is "Set", loading is carried out correctly.
- Because the subroutine stack (SR) has two levels, subroutines can be handled on two levels. Long subroutine calls (those in which another page is called out) can also be executed from any level.

● Long subroutine calls (those in which another page is called out) are enabled by executing the LPC instruction prior to CAL. Omitting the LPC instruction (and PA = PB) serves as a short subroutine call (calling a subroutine on the same page).

17) RTN

Naming : Return from Subroutine

Binary operating code :

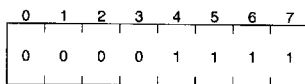

Status : Set

Format : I

Function : PC ← SR1 PA, PB ← PSR1
 SR1 ← SR2 PSR1 ← PSR2
 SR2 ← SR2 PSR2 ← PSR2
 ST ← 1

〈Objective〉 This returns execution from the called-out subroutine to the program from which control was called.

〈Description〉 Information about the return address taken from the stack register (SR1) is sent to PC, and execution returns to the main routine. At the same time, the contents of the page stack register (PSR1) are sent to PA and PB.

18) LPC

Naming : Load Page Buffer Register from Immediate

Binary operating code :

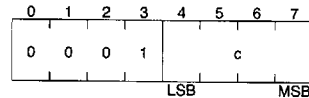

Status : Set

Format : III

Operand : ROM page address $0 \leq I (C) \leq 10$

Function : PB ← I (C)

〈Objective〉 This loads a new ROM page address to the page buffer (PB) register. This operation is necessary when an instruction is used to call a long branch.

〈Description〉 The PB register is loaded in accordance with the four bits from the C field of the instruction.

19) AMAAC

Naming : Add Accumulator to Memory

Binary operating code :

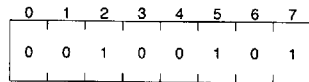

Status : Carry to status

Format : I

Functions : Acc ← M (Y) + Acc

ST ← 1 (when total > 15)

ST ← 0 (when total ≤ 15)

〈Description〉 The contents of the memory location addressed by the Y register are added to those of the accumulator, and the results are accumulated in the accumulator. The carry information is then sent to the status as the result. If the total is larger than 15, a carry operation occurs, and "1" is set as the status. The contents of the memory do not change.

20) SAMAN

Naming : Subtract Accumulator to Memory

Binary operating code :

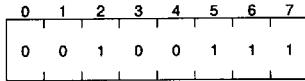

Status : Carry to status

Format : I

Functions : $Acc \leftarrow M(Y) - Acc$

$ST \leftarrow 1$ (when $A \leq M(Y)$) } Initial
 $ST \leftarrow 0$ (when $A > M(Y)$) } conditions

〈Description〉 Two's complement addition is carried out on the contents of the accumulator, and the contents of the accumulator subtracted from the memory word addressed by the Y register, with the results being accumulated in the accumulator. If the value in the accumulator is smaller than the memory word, or is equivalent to it, the status is "Set", to indicate that a borrow operation was not carried out. If the value in the accumulator is larger than the memory word, a borrow operation occurs, and the status is reset to 0.

21) IMAC

Naming : Increment Memory

Binary operating code :

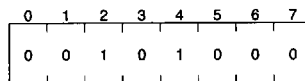

Status : Carry to status

Format : I

Functions : $Acc \leftarrow M(Y) + 1$

$ST \leftarrow 1$ (when $M(Y) = 15$) } Initial
 $ST \leftarrow 0$ (when $M(Y) < 15$) } conditions

〈Description〉 The contents of the memory addressed by the Y register are read out. "1" is added to this word, and the results are accumulated in the accumulator. The carry information is sent to the status as the result. If the total is greater than 15, the status is "Set". The memory does not change.

22) DMAN

Naming : Decrement Memory

Binary operating code :

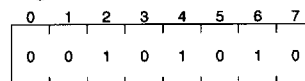

Status : Carry to status

Format : I

Functions : $Acc \leftarrow M(Y) - 1$

$ST \leftarrow 1$ (when $M(Y) \geq 1$) } Initial
 $ST \leftarrow 0$ (when $M(Y) = 0$) } conditions

〈Description〉 The contents of the memory addressed by the Y register are read out. "1" is subtracted from this word (FH addition), and the results are accumulated in the accumulator. The carry information is sent to the status as the result. If the memory is greater than 1, the status is "Set", to indicate that a borrow operation was not carried out. The contents of the memory do not change.

23) IA

Naming : Increment Accumulator

Binary operating code :

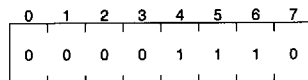

Status : Set

Format : I

Function : $Acc \leftarrow Acc + 1$

〈Description〉 "1" is added to the contents of the accumulator, and the result is returned to the accumulator. There is no influence on the carry status.

24) IYC

Naming : Increment Y-Register and 1 on Carry

Binary operating code :

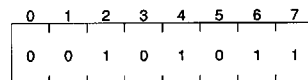

Status : Carry to status

Format : I

Functions : $Y \leftarrow Y + 1$

$ST \leftarrow 1$ (when $Y = 15$) } Initial
 $ST \leftarrow 0$ (when $Y < 15$) } conditions

〈Description〉 "1" is added to the contents of the Y register, and the result is returned to the Y register. The carry information is sent to the status as the result. If the total is greater than 15, the status is "Set".

25) DAN

Naming : Decrement Accumulator and Status 1 Borrow

Binary operating code :

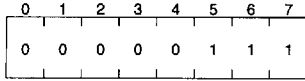

Status : Carry to status

Format : I

Functions : $Acc \leftarrow Acc + 1$

$ST \leftarrow 1$ (when $A \geq 1$) } Initial
 $ST \leftarrow 0$ (when $A = 0$) } conditions

〈Description〉 “1” is subtracted from the contents of the accumulator, and if the result (FH addition) produces a borrow operation, the status is reset to a logic of 0. If the contents of the accumulator are greater than 1, no borrow operation is carried out, and the status is set to 1.

26) DYN

Naming : Decrement Y-Register and Status 1 on Not Borrow

Binary operating code :

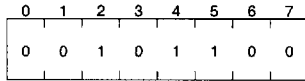

Status : Carry to status

Format : I

Functions : $Y \leftarrow Y - 1$

$ST \leftarrow 1$ (when $Y \geq 1$) } Initial
 $ST \leftarrow 0$ ($Y = 0$) } conditions

〈Objective〉 This subtracts only “1” from the contents of the Y register.

〈Description〉 “1” is subtracted from the contents of the Y register. This is done by adding a negative 1 (F+). The carry information is sent to the status as the result. If the result is not equal to 15, the status is reset to 0, to indicate that a borrow operation was carried out.

27) EMAA

Naming : Exclusive OR Memory and Accumulator

Binary operating code :

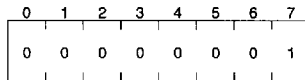

Status : Set

Format : I

Function : $Acc \leftarrow M(Y) \oplus + Acc$

〈Description〉 An exclusive logical OR is carried out on the contents of the memory addressed by the Y register and the contents of the accumulator, and the results are accumulated in the accumulator.

28) NEGAZ

Naming : Negative Accumulator and Status 1 on Zero

Binary operating code :

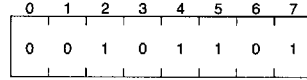

Status : Carry to status

Format : I

Functions : $Acc \leftarrow \overline{Acc} + 1$

$ST \leftarrow 1$ (when $A = 0$) } Initial
 $ST \leftarrow 0$ (when A is not equal to 0) } conditions

〈Objective〉 This makes the word in the accumulator a two's complement.

〈Description〉 The two's complement of the accumulator is calculated by adding “1” to the one's complement of the accumulator, and the results are accumulated in the accumulator. The carry information is sent to the status. If the contents of the accumulator are 0, a carry operation occurs, and the status is set to 1.

29) ALEM

Naming : Accumulator Less Equal Memory

Binary operating code :

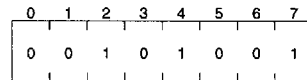

Status : Carry to status

Format : I

Functions :

$Acc \leq M(Y) ?$
 $ST \leftarrow 1$ (when $Acc \leq M(Y)$)
 $ST \leftarrow 0$ (when $Acc > M(Y)$)

〈Description〉 The value in the accumulator is subtracted from the contents of the memory location addressed by the Y register using complement addition. The carry information is sent to the status as the result. A status of 1 indicates that the value in the accumulator is less than or equal to the memory word. Neither the contents of the memory nor those of the accumulator change.

30) ALEC

Naming : Accumulator Less Equal Immediate

Binary operating code :

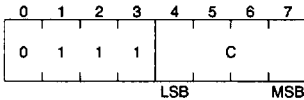

Status : Carry to status

Format : III

Operand : Constant value $0 \leq I (C) \leq 15$

Functions : $Acc \leq I (C) ?$

$ST \leftarrow 1$ (when $Acc \leq I (C)$)

$ST \leftarrow 0$ (when $Acc > I (C)$)

〈Objective〉 This compares the contents of the accumulator and the constant value arithmetically.

〈Description〉 The value in the accumulator is subtracted from the constant (which is in the C field of the instruction), using complement addition. The carry information is sent to the status as the result. If the accumulator contents are less than or equal to the constant, the status is "Set". The contents of the accumulator do not change.

31) MNEZ

Naming : Memory Not Equal Zero

Binary operating code :

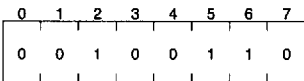

Status : Comparison result to status

Format : I

Functions : $M (Y) \neq 0 ?$

$ST \leftarrow 1$ (when $M (Y) \neq 0$)

$ST \leftarrow 0$ (when $M (Y) = 0$)

〈Objective〉 This compares the memory word to 0.

〈Description〉 The contents of the memory addressed by the Y register are compared logically to 0. The comparison information is sent to the status as the result. If the memory value is not 0, the status is "Set".

32) YNEA

Naming : Y-Register Not Equal Accumulator

Binary operating code :

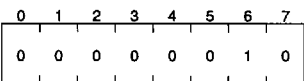

Status : Comparison result to status

Format : I

Functions : $Y \neq Acc ?$

$ST \leftarrow 1$ and (when $Y \neq Acc$)

$ST \leftarrow 0$ and (when $Y = Acc$)

〈Objective〉 This compares the contents of the Y register to those of the accumulator, to see if they match.

〈Description〉 The contents of the Y register are compared logically to the contents of the accumulator. The comparison information is sent to the status as the result. If the contents do not match, the status is "Set".

33) YNEC

Naming : Y-Register Not Equal Immediate

Binary operating code :

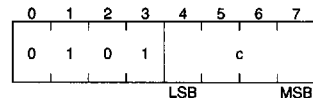

Status : Comparison result to status

Format : III

Operand : Constant value $0 \leq I (C) \leq 15$

Functions : $Y \neq C ?$

$ST \leftarrow 1$ (when $Y \neq C$)

$ST \leftarrow 0$ (when $Y = C$)

〈Description〉 The constant in the Y register is compared logically the four bits in the C field of the instruction. The comparison result is sent to the status. If the operand and the contents of the Y register do not match, the status is set to 1.

34) KNEZ

Naming : K Not Equal Zero

Binary operating code :

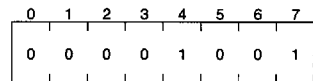

Status : Status set only if comparison results do not match

Format : I

Function : When $K_0 \sim K_3$ are not equal to 0, status is set

〈Objective〉 This tests to see whether or not $K_0 \sim K_3$ are 0.

〈Description〉 The data which is not 0 has been input, the status is set.

35) LAK

Naming : Load Accumulator from K

Binary operating code :

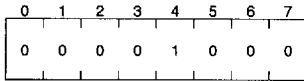

Status : Set

Format : I

Function : $Acc \leftarrow K_0 \sim K_3$

〈Description〉 The data in $K_0 \sim K_3$ are sent to the accumulator.

36) SEO

Naming : Set S-Output Register Latch

Binary operating code :

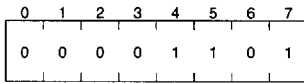

Status : Set

Format : I

Function : $S(Y) \leftarrow 1 \quad 0 \leq Y \leq 7$

OUT $\leftarrow 1$ (Option D) $Y = 8$

$S_0 \sim S_7 \leftarrow 1$ (High-Z) $Y = 9$

No operation $10 \leq Y \leq 15$

〈Objective〉 When $0 \leq Y \leq 7$, this sets one S output line to a logic of 1.

When $Y = 8$, the OUT output pin alternates between HIGH and LOW at the carrier frequency.

When $Y = 9$, this sets the $S_0 \sim S_7$ output lines to a logic of 1.

When $10 \leq Y \leq 15$, no operation takes place.

〈Description〉 When the contents of the Y register are between 0 and 7, the contents of the Y register select the appropriate S output ($S_0 \sim S_7$).

When the contents of the Y register are 8, the OUT output port is selected. When the contents of the Y register are 9, $S_0 \sim S_7$ are all selected.

When the contents of the Y register are between 10 ~ 15, the No Operation instruction is executed.

37) REO

Naming : Reset S-Output Register Latch

Binary operating code :

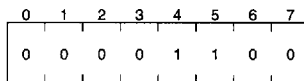

Status : Set

Format : I

Function : $S(Y) \leftarrow 0 \quad 0 \leq Y \leq 7$

OUT $\leftarrow 0 \quad Y = 8$

$S_0 \sim S_7 \leftarrow 0 \quad Y = 9$

No operation $10 \leq Y \leq 15$

〈Objective〉 When $0 \leq Y \leq 7$, this sets one S output line to a logic of 0.

When $Y = 8$, the OUT output pin is set to 0.

When $Y = 9$, this sets the $S_0 \sim S_7$ lines to a logic of 0.

When $10 \leq Y \leq 15$, no operation takes place.

〈Description〉 When the contents of the Y register are between 0 and 7, the contents of the Y register select the appropriate S output ($S_0 \sim S_7$).

When the contents of the Y register are the OUT output port is selected.

When the contents of the Y register are 9, $S_0 \sim S_7$ are all selected.

When the contents of the Y register are between 10 ~ 15, the No Operation instruction is executed.

38) WDTR

Naming : Watch Dog Timer Reset

Binary operating code :

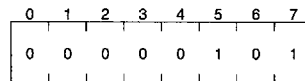

Status : Set

Format : I

Function : Resets the watchdog timer

〈Objective〉 Normally, the counter for the watchdog timer must be reset before it overflows, and this instruction is used to control the reset signal.

39) HALT

Naming : HALT

Binary operating code :

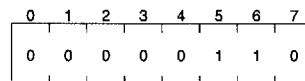

Status : Set

Format : I

Function : Implements the HALT function

〈Objective〉 This stops oscillation and sharply reduces the amount of current consumed.

40) NOP

Naming : No Operation

Binary operating code :

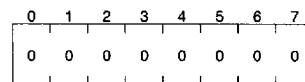

Status : Set

Format : I

Function : No operation

● Development support systems

(1) Software support (RDS-BU2)

In order to facilitate software development with the BU2463 series, the following software configuration has been provided as a development support tool.

1) Software development support tools

The following software development support tools are available.

1. Personal computer system (RDS-BU2)

The personal computer system requires the ability to run MS-DOS* as the operating system (OS). A sample system configuration is shown for reference in Figure 18.

2) Software configuration

The following are available as software development support programs. These software programs require the ability to run MS-DOS* as the OS.

1. Text editor

This software program allows source programs to be created and modified. It can be used as a general-purpose screen editor.

2. Assembler

This is used to convert source programs written as mnemonics to objects, and to create assembly lists and object files. The general-purpose cross-assembler PROASM-II** is used.

3. BUS2463 instruction library

This can be used by including the BU2463 macro library in the general-purpose cross-assembler PROASM-II**.

4. Simulator

Using objects which have been created, target machines can be run in simulated operation in the host machine, in order to monitor port and register statuses. This is used to run programs in the CPU in advance and to debug them, before running them with the evaluation board.

When object files confirmed with the above software programs have been completed, trial production of microcomputers for the pertinent system can be carried out at Rohm.

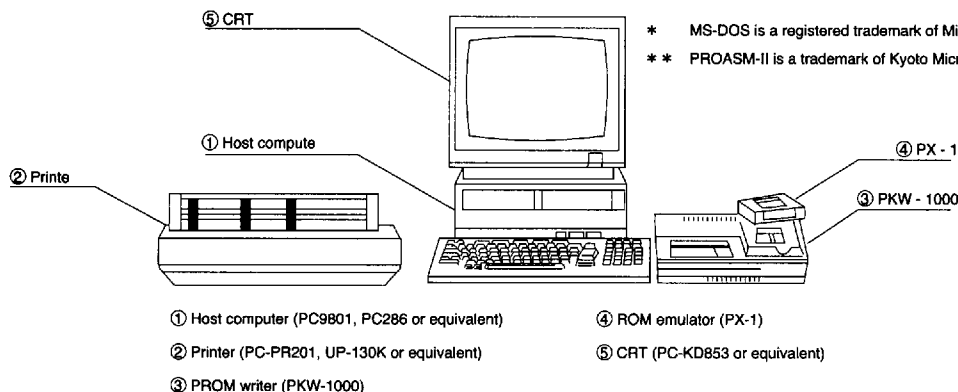

Fig. 18 Personal computer system (RDS-BU2)

● Development support system software

This section explains the various syntaxes used to activate this development support system, and the ways in which the various software programs are used.

1. Source program formats

Source programs are created using a screen editor in MS-DOS*. Source program statements consist of the following four fields.

| Label field | Operation field | Operand field | Comment field |
|-------------|-----------------|---------------|---------------|
|-------------|-----------------|---------------|---------------|

These fields must be lined up in the configuration shown above.

Blanks or tabs are used as delimiters between fields. Consequently, the next field begins with the first character following the blank. The first character in a label or operation field must be an English alphabetic character. Also, if the first column is blank, it indicates that the label field is not limited.

Figure 19 shows an example of a source program, and Figure 20 shows an example of the assembly output for this program.

```

INCLUDE BU2463. LIB
      ORG    $000
      LYC    0
AAA   LMCiy  0
      YNEC   0
      BR     AAA
      END
    
```

Fig. 19 Example of source program

IA80 Ver.2.08(C) 1985 by IWASAKI / K.M.C PAGE 1

```

1 0000          INCLUDE BU2463. LIB
2 0000          list
3 0000          ORG    $000
4 0000  40  +   LYC    0
5 0001  60  + AAA  LMCiy  0
6 0003  50  +     YNEC   0
7 0007  83  +     BR     AAA
8 000f          END
    
```

No Fatal error(s)

Fig. 20 Example of assembly output

(1) Label field

The label field is designed to indicate the location of one instruction in the program in a way that is easy to reference and easy to remember, and is configured of between 1 and 128 English alphabetic letters. Label fields must be clearly differentiated, so that locations are also clearly differentiated.

(2) Operation field

Operation fields are configured of operation codes which indicate the function which the instruction implements. There must be at least one blank or tab between an operation field and a label field.

(3) Operand field

Operand fields are configured of operands which indicate the target of the action being implemented. There must be at least one blank or tab between an operation code and an operand.

(4) Comment field

Comments begin with a semi-colon and end with a carriage return, line and field.

●Hardware support

The following hardware support systems are available, to make it faster and easier to develop target systems for the BU2463 series.

1. BU2495 (Evaluation chip for the BU2463 series)

(1) Overview

The BU2495 is an IC designed for evaluation of the BU2463 series of 4-bit, single-chip microcomputers. Basically, it is configured of the same IC chips as the BU2463, but instead of the internal mask ROM unit used to write programs, it is configured so that a program memory (ROM or RAM) can be externally attached.

By writing programs to this externally attached program ROM, the user can treat the system in the same way as the ICs of the BU2463 series for the target system. Therefore, incorporating the BU2495 and the

EV2403C evaluation board with the externally attached program memory into user system makes program and system debugging easier.

(2) Features

- Emulation of the BU2463 series of 4-bit, single-chip microcomputers is enabled.
- The system is configured of a CMOS processor which allows comprehensive evaluation of the BU2463 series.
- The instruction system is the same as that of the BU2463 series.
- External attachment of a program ROM (2732, 2764, 27128, or 27256) on the BU2495 enables the system to be handled just like the BU2463 series.
- Using the PA₀ ~ PA₃ and PC₀ ~ PC₅ which control up to 640 words of ROM addresses (8 bits/word) and the ROM data outputs I₀ ~ I₇ enables linking with an external program ROM.

(3) Block diagram

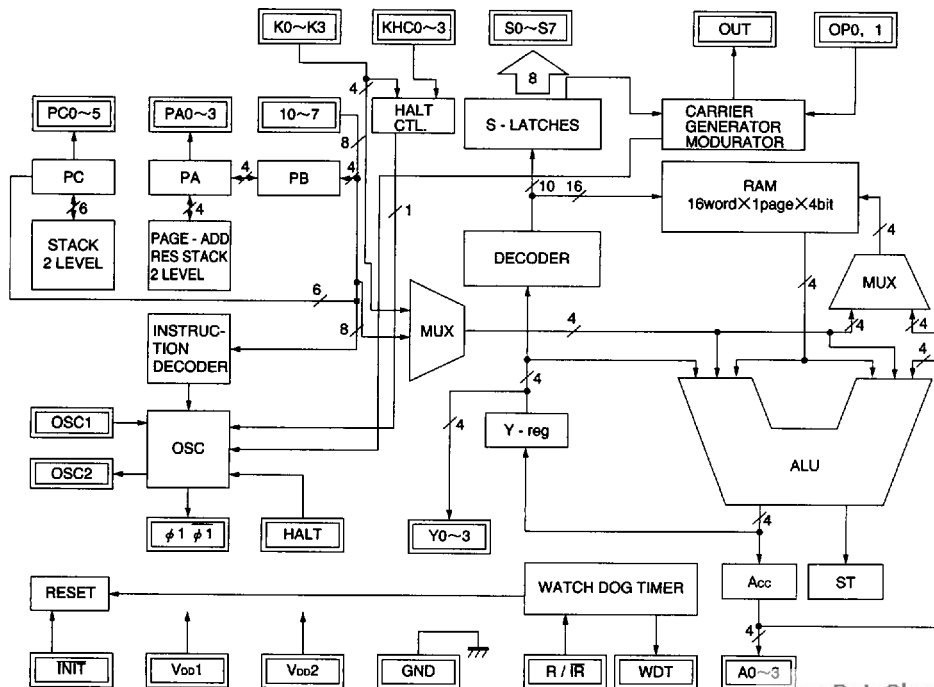

Fig. 21

(6) Description of pin functions

| Pin Name | I/O | Function | | |
|------------------|--------|--|-----------------|-------------------------|
| V _{DD1} | | Used to connect 2.0 V ~ 4.0 V power supply. | | |
| GND | | Reference voltage for all inputs and outputs (0 V). | | |
| INIT | Input | Manual reset input. Setting this pin to LOW initializes the S output port and sets the ROM address to 0 page, 0 address. | | |
| K0~K3 | Input | 4-bit input ports. Internal pull-up resistance. Setting this pin to LOW cancels the HALT function. (The HALT cancel function can be set using the KHC pin.) | | |
| S0~S7 | Output | Each of these can be set and reset independently (or all at once). The output format is Nch open drain. | | |
| OUT | Output | Remote control signal output port which can be used to drive large currents. The output format is CMOS output (output HIGH current side). | | |
| OSC1 | Input | A ceramic resonator is connected between this pin and OSC2. Built-in feed back resistor between this pin and OSC2. | | |
| OSC2 | Output | A ceramic resonator is connected between this pin and OSC1. | | |
| KHC0~3 | Input | The HALT cancel function is turned on and off by means of the K input to these pins. Setting these pins to HIGH makes the HALT cancel function effective-based on the corresponding K input. | | |
| OP0~1 | Input | Carrier mode selection pins. Four different carrier modes can be set. | | |
| | | OP ₀ | OP ₁ | Carrier mode |
| | | 0 | 0 | A : 12 / fosc 1 / 2Duty |
| | | 0 | 1 | B : 12 / fosc 1 / 3Duty |
| | | 1 | 0 | C : 8 / fosc 1 / 2Duty |
| | | 1 | 1 | D : No carrier |
| HALT | Input | External HALT input; however, HALT activation using an instruction takes precedence. | | |
| φ1, φ2 | Output | Timing signal outputs | | |
| A0~A3 | Output | These are used to output the accumulator contents. | | |
| Y0~Y3 | Output | These are used to output the contents of the Y register. | | |
| V _{DD2} | — | Power supply for interface block with EPROM. A power supply of 4.5 ~ 5.5 is connected. | | |
| R/IR | Input | Watchdog timer mode setting pins. | | |
| WDT | Output | Monitor output for the reset signal of the watchdog timer. | | |
| PC0~5, PA0~3 | Output | These are used to output addresses to an external EPROM. | | |
| I0~I7 | Input | These are used to input data from an EPROM. | | |

(7) Absolute maximum constants (Ta=25°C)

| Parameter | Symbol | Maximum rating | Unit |
|-----------------------|------------------|----------------|------|
| Power supply voltage | V _{DD} | -0.3~7.0 | V |
| Power dissipation | P _d | 700* | mW |
| Operating temperature | T _{opr} | -10~+70 | °C |
| Storage temperature | T _{stg} | -55~+125 | °C |

* Reduced by 7mW for each increase in Ta of 1°C over 25°C.

(8) Electrical characteristics (Unless otherwise noted, Ta=25°C, VDD1=3.0V, VDD2=5.0V)

| Parameter | Symbol | Min. | Typ. | Max. | Unit | Conditions |
|-----------------------------------|---------------------|---------------------|------|---------------------|------|---|
| INIT input current (HIGH) | I _{IHIT} | — | 0.1 | 5 | μA | V ₁ =V _{DD1} |
| INIT input current (LOW) | I _{ILIT} | — | 15 | — | μA | V ₁ =GND |
| K input current (HIGH) | I _{IHK} | — | 0.1 | 5 | μA | V ₁ =V _{DD1} |
| K input current (LOW) | I _{ILK} | — | 40 | — | μA | V ₁ =GND |
| KHC input voltage (HIGH) | V _{IHKHC} | 0.7V _{DD1} | — | V _{DD1} | V | — |
| KHC input voltage (LOW) | V _{ILKHC} | 0 | — | 0.3V _{DD1} | V | — |
| OP input voltage (HIGH) | V _{IHOP} | 0.7V _{DD1} | — | V _{DD1} | V | — |
| OP input voltage (LOW) | V _{ILOP} | 0 | — | 0.3V _{DD1} | V | — |
| R/ \bar{R} input voltage (HIGH) | V _{IHRIR} | 0.7V _{DD1} | — | V _{DD1} | V | — |
| R/ \bar{R} input voltage (LOW) | V _{ICRIR} | 0 | — | 0.3V _{DD1} | V | — |
| HALT input voltage (HIGH) | V _{IHHALT} | 0.7V _{DD1} | — | V _{DD1} | V | — |
| HALT input voltage (LOW) | V _{ILHALT} | 0 | — | 0.3V _{DD1} | V | — |
| I input voltage (HIGH) | V _{IHI} | 0.7V _{DD2} | — | V _{DD2} | V | — |
| KHC input current (HIGH) | I _{IHKHC} | — | — | 1 | μA | V ₁ =V _{DD1} |
| KHC input current (LOW) | I _{ILKHC} | — | — | -1 | μA | V ₁ =GND |
| OP input current (HIGH) | I _{IHOP} | — | — | +1 | μA | V ₁ =V _{DD} |
| OP input current (LOW) | I _{ILOP} | — | — | -1 | μA | V ₁ =GND |
| R/ \bar{R} input current (HIGH) | I _{IHRIR} | — | — | +1 | μA | V ₁ =V _{DD1} |
| R/ \bar{R} input current (LOW) | I _{ILRIR} | — | — | -1 | μA | V ₁ =GND |
| HALT input current (HIGH) | I _{IHHALT} | — | — | +1 | μA | V ₁ =V _{DD1} |
| HALT input current (LOW) | I _{ILHALT} | — | — | -1 | μA | V ₁ =GND |
| I input current (LOW) | I _{ILI} | — | — | -1 | μA | V ₁ =GND |
| PC, PA output voltage (HIGH) | V _{OHP} | — | 0.2 | — | V | I _{OH} =1mA |
| PC, PA output voltage (LOW) | V _{OLP} | — | 0.2 | — | V | I _{OL} =1mA |
| A output voltage (HIGH) | V _{OHA} | — | 0.2 | — | V | I _{OH} =1mA |
| A output voltage (LOW) | V _{OLA} | — | 0.2 | — | V | I _{OL} =1mA |
| Y output voltage (HIGH) | V _{OHY} | — | 0.2 | — | V | I _{OH} =1mA |
| Y output voltage (LOW) | V _{OLY} | — | 0.2 | — | V | I _{OL} =1mA |
| O output voltage (HIGH) | V _{OHP} | — | 0.2 | — | V | I _{OH} =1mA |
| O output voltage (LOW) | V _{OLO} | — | 0.2 | — | V | I _{OL} =1mA |
| WDT output voltage (HIGH) | V _{OHWDT} | — | 0.2 | — | V | I _{OH} =1mA |
| WDT output voltage (LOW) | V _{OLWDT} | — | 0.2 | — | V | I _{OL} =1mA |
| S output voltage (LOW) | V _{OLS} | — | 0.2 | — | V | I _{OL} =1mA |
| OUT output voltage (HIGH) | V _{OHRM} | — | 2.5 | — | V | I _{OH} =8mA |
| OSC2 output voltage (LOW) | V _{OLOSC} | — | 0.5 | — | V | I _{OL} =160 μA |
| OSC2 output voltage (HIGH) | V _{OHOOSC} | — | 2.5 | — | V | I _{OH} =160 μA |
| S output leakage current | I _{LS} | — | — | 5 | μA | V ₀ =V _{DD1} , output Tr: OFF |
| OUT output current (HIGH) | I _{OLRM} | — | 25 | — | μA | V ₀ =V _{DD1} , output Tr: OFF |
| OSC1 feedback current | I _{OSC1} | — | 3 | — | μA | V _{OSC1} =V _{DD1} |
| Static current consumption | I _{DDST} | — | — | 10 | μA | I _n standby state |
| Operating current consumption | I _{DDOP} | — | 0.3 | — | mA | f _{ck} =455kHz |
| Operating frequency | f _{opr} | 300 | — | 1000 | kHz | — |

2. EV2403C evaluation board for the BU2463 series

(1) Overview

The EV2403C is an evaluation board for use with the BU2463 series of 4-bit, single-chip microcomputers. It is designed to provide an environment as close as possible to the final product at the application program development stage, so that system operation functions can be evaluated. The main features are listed below.

- The BU2495 is used as the evaluation ship.
- The board and the application system are connected by means of an emulation cable (18-pin DIP).
- An EPROM is used as the program memory (2732, 2764, 27128, or 27256).
- The instruction system and the I/O specifications are basically the same as those of the BU2463 series.

(2) Product specifications

〈Product composition〉

- EV2403C board module (glass epoxy resin PWB)

External dimensions : 67 × 60 (mm)

Power supply voltage : 2.0 ~ 4.0 (V)

Operating temperature : 0 ~ 50°C

- 18-pin DIP emulation cable

(3) Connection settings

Emulation can be carried out using the connectors listed below. (See Fig. 22.)

【J1】 Emulation socket

This connects the cable to the target system. Power is also supplied to the evaluation board through this cable.

| Pin No. | Signal | Pin No. | Signal |
|---------|--------------------------|---------|--------|
| 1 | $\overline{\text{INIT}}$ | 10 | S3 |
| 2 | GND | 11 | S4 |
| 3 | K0 | 12 | S5 |
| 4 | K1 | 13 | S6 |
| 5 | K2 | 14 | S7 |
| 6 | K3 | 15 | OUT |
| 7 | S0 | 16 | OSC2 |
| 8 | S1 | 17 | OSC1 |
| 9 | S2 | 18 | VDD |

【J2】 EPROM power supply

The J2 connector is used if power is supplied to the EPROM from a separate source. Switching is done through the S1 short post 1.

【J3】 Monitor pin

Internal operations in the BU2495 can be monitored. The following signals can be monitored : Acc0 ~ 3, Yreg0 ~ 3, ϕ 1, ϕ 2, WDT

【J4】 Oscillation monitor pin

Oscillation output signals can be monitored.

(4) Option settings

The following settings for options must be entered, depending on the specifications of the application.

【S1】 Setting the HALT cancel function

Shorting the HIGH sides of short posts 1 ~ 4 enables the HALT cancel function to be set, based on the corresponding K input. If the HALT cancel function is not to be set, the L side should be shorted.

| Set pin | K0 | K1 | K2 | K3 |
|------------------------------|----|----|----|----|
| Short post | 1 | 2 | 3 | 4 |
| HALT cancel function set | H | H | H | H |
| HALT cancel function not set | L | L | L | L |

【S2】 Setting the watchdog timer reset function using the carrier output and OUT output

- Setting the carrier output

Setting short posts 1 and 2 as indicated in the table below enables the carrier output to be set.

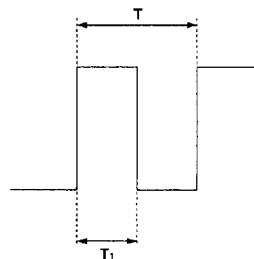

| Short post | | Carrier output |
|------------|---|---|
| 1 | 2 | |
| L | L | $T=1/f_{\text{CAR}}=12/f_{\text{OSC}}$, $T1/T=1/2$ |
| L | H | $T=1/f_{\text{CAR}}=12/f_{\text{OSC}}$, $T1/T=1/3$ |
| H | L | $T=1/f_{\text{CAR}}=8/f_{\text{OSC}}$, $T1/T=1/2$ |
| H | H | No carrier output |

f_{CAR} : Carrier frequency, f_{OSC} : Oscillation frequency.

- Setting the watchdog timer reset function using the OUT output

Setting short post 3 on the LOW side enables the OUT output signal to be used to reset the watchdog timer.

| | |
|--|---|
| Short post | 3 |
| Watchdog timer reset using OUT output signal | L |
| Watchdog timer not reset using OUT output signal | H |

【Options which cannot be set using the short posts】

Some of the mask options which can be set with the BU2463 chip cannot be set using the short posts. Each of these options is supported by an evaluation chip. When they are used, check to make sure the pertinent evaluation chip on the evaluation board has been set so that the desired option can be used.

○Options which cannot be set on the EV2403C

●Whether or not there is an internal oscillation circuit capacitance based on a ceramic resonator

●Selection of the S6 and S7 states in HALT mode

The EV2403C supports the following six types of evaluation chips.

| Evaluation chip | Oscillation capacitance | State in HALT mode | |
|-----------------|-------------------------|--------------------|----------------|
| | | S6 | S7 |
| BU2495-1 | YES | L | L |
| BU2495-2 | | Previous state | L |
| BU2495-3 | | Previous state | Previous state |
| BU2495-4 | NO | L | L |
| BU2495-5 | | Previous state | L |
| BU2495-6 | | Previous state | Previous state |

(5) Usage environment settings

The following settings should be entered based on the environment in which the evaluation board is used.

【S3】 EPROM power supply switching, external HALT setting and clock input switching

●EPROM power supply switching

Shorting the short post 3 on the LOW side enables power to be supplied to the evaluation chip from J1, and enables power to be supplied to the EPROM from J2.

This makes it possible to run the EPROM on a 5V power supply and the evaluation chip on a 3V power supply.

If the evaluation chip and the EPROM are being supplied from the same power supply, 1 should be shorted on the HIGH side. This causes a short between the V_{DD} pins of J1 and J2, one of which then supplies power, so that both units can be driven from the same power supply.

| | |
|---|---|
| Short post | 3 |
| J1 and J2 driven from separate power supply | L |
| J1 and J2 driven from same power supply | H |

●Setting an external HALT

Shorting short post 4 on the HIGH side enables a HALT state to be applied from an external source. Normally, this should be shorted on the LOW side.

●Switching the clock input

Switching between short posts 1 and 2 enables automatic oscillation to be initiated by the external clock input and the resonator.

| | | |
|--------------------------------|---|---|
| Short post | 1 | 2 |
| External clock input | L | L |
| Internal automatic oscillation | H | H |

When using the internal clock, the resonator should be mounted on the EV2403C. The oscillation circuit constant varies depending on the resonator, so the manufacturer of the resonator should be consulted regarding recommended values.

(See XTAL, C1, and C2 in Figure 22.)

【S4】 EPROM settings

Switching 6 enables mounting of the 2732, 2764, 27128, and 27256.

With the 2732, however, Pin 1 of the ROM chip should be mounted so that it fits under Pin 3 of the socket.

| | | |
|------------|---|---|
| Short post | 1 | 2 |
| 2732 | H | H |
| 2764 | H | L |
| 27128 | H | L |
| 27256 | L | L |

(6) Operation notes

●Of the functions available with this chip, the Power On Reset function is not supported by the evaluation board. When evaluating program operation functions with the evaluation board, therefore, always attach an external reset capacitor. The DS and ES should be used to evaluate the Power On Reset function.

●When evaluating BU2466 programs, the S4 and S5 pins (Pins 11 and 12 on J1) should be used in the open state.

●An 18-pin DIP IC socket must be provided in the application system. The emulation cable is inserted into this socket.

- Factors such as the wiring capacitance of the emulation cable can sometimes affect normal oscillation of the ceramic resonator in the application system. If this happens, mount the resonator on the emulation board.
- If power to the EV2403C is being supplied from the application system through the emulation cable, make sure the application system is capable of supplying sufficient power.

- The EV2403C is designed for evaluation of the operation functions of the program, and AC and DC characteristics may differ from those of the mass-produced chips. The DS and ES should be used for evaluation of electrical characteristics.

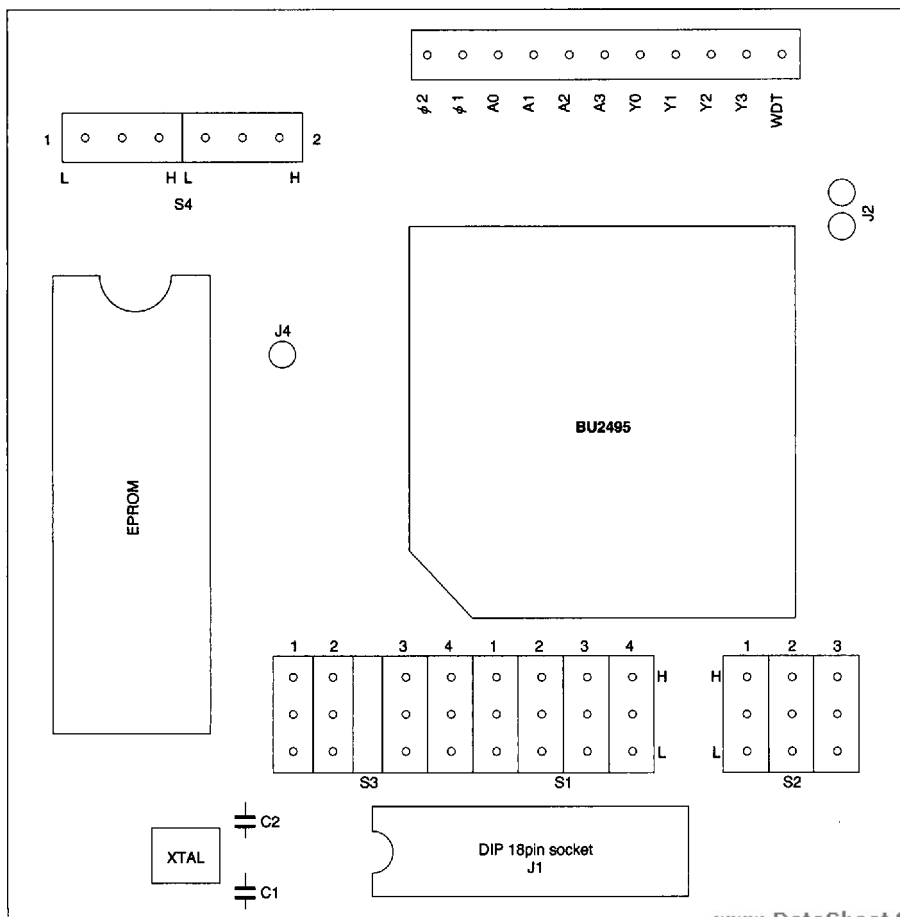

Fig. 22 Parts layout (EV2403C)

1 : Initial reset circuit

(1) Using the internal power on reset circuit

The BU2463 series is equipped with an internal Power On Reset circuit. The Power On Reset function works even if the INIT pin is in open state. The timing at which the reset signal is generated is proportional to the oscillation clock cycle (t_{osc}).

A clock of four or more stable machine cycles (24 clock pulses) must be input to the OSC1 pin during the valid reset period.

(2) Using an external capacitor

If a longer reset timing is required than that which can be provided with the internal Power On Reset circuit, such as for power supplies with a slow rise time and power supplies with strong chattering ($> 1\text{ms}$ at $f_{osc} = 455\text{kHz}$), a capacitor C_0 is connected between the INIT pin and the GND pin.

The CR integrated circuit is comprised of C_0 and the internal pull-up resistance of the IC (approximately $400\text{k}\Omega$). When the power is turned on, the integrated waveform of the power supply rise waveform is input through the INIT pin, and a reset is initiated which remains effective until the input threshold voltage of the internal inverter is exceeded. During the period in which the reset is valid, a clock with a stable cycle exceeding four machine cycles (24 clock pulses) must be input to the OSC1 pin.

The constant should be set high enough to accommodate the power supply rise time (including chattering) and the oscillation rise time subsequent to reaching the valid power supply voltage (the rise time for a crystal resonator is longer than that for a ceramic resonator).

If the power supply rise time is within 10ms , $0.1\ \mu\text{F}$ is an appropriate value for C_0 .

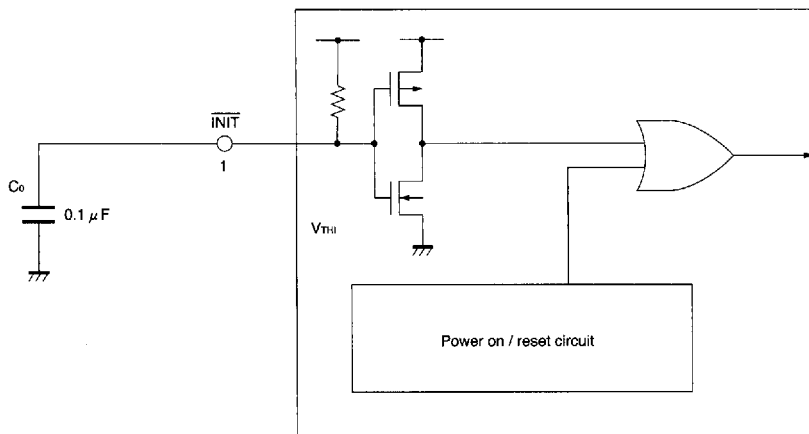

Fig. 23 Initial reset circuit

2. Oscillation circuit

Attaching an external ceramic (crystal) resonator between OSC1 and OSC2 enables configuration of a ceramic (crystal) oscillation circuit. In order to minimize effects on the board wiring and other elements, the

resonator should be placed as close to OSC1 and OSC2 as possible.

The circuit shown in Figure 24 can be used by using a mask option (internal capacitor).

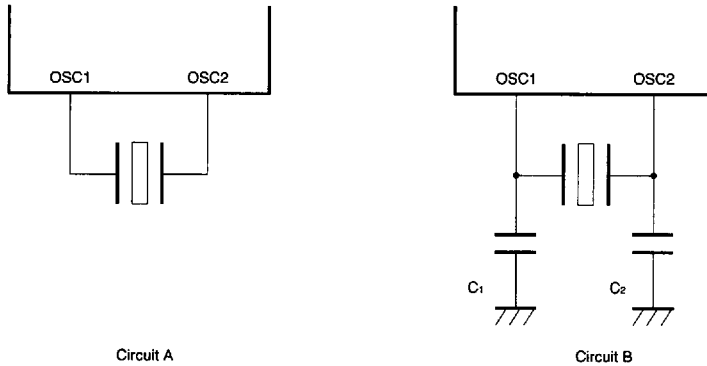

Fig. 24 Example of oscillation circuit (configuration)

a : Precautions regarding oscillation when the power is turned on

When using an external capacitor on the initial reset circuit, the setting should ensure that the valid INIT signal is longer than the power supply and oscillation rise times. If operation begins before the oscillation rise-

time has been completed, erroneous operation may occur. Generally, crystal resonators have a longer rise time than ceramic resonators, so special caution is required if using a crystal resonator.

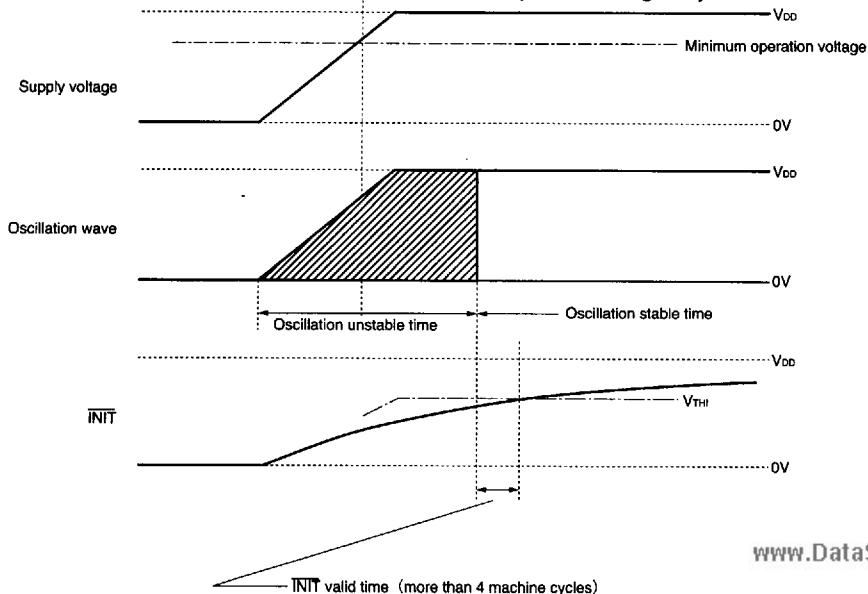

Fig. 25 Power supply waveform when power is turned on (expanded on time axis)

b : Precautions regarding oscillation when HALT is cancelled

When a HALT state is cancelled, oscillation is resumed. At this point, in order to assure sufficient time for the oscillation to stabilize, the BU2463 series is provided with an internal wait timer (6144 effective clock pulses / f_{osc}) based on the hardware counter. During that period, no clock pulses are supplied to internal circuits, so no program execution is carried out. Consequently, input which is faster than the wait timer timing cannot be read.

The oscillation rise time varies depending on the type

of resonator used. Please consult the manufacturer of the resonator for specific time information.

c : Correspondence table for resonators and application circuits

Currently, the resonators listed below can be used with the circuits and oscillation constants given in the table. For more detailed information, please consult the manufacturer of the resonator before selecting a certain circuit and constant.

$f_{osc}=400\text{kHz}$

| Prod. No. | Maker | Circuit | Osc. constant | Power supply voltage range |
|---------------|---------------------|---------|---------------|----------------------------|
| CSB400P | Murata Mfg. | A | — | 2.0~4.0 |
| KBR400BK70 | Kyocera corp. | A | — | 2.0~4.0 |
| FCR400K3 | TDK | A | — | 2.0~4.0 |
| EFO-A-400K04A | Matsushita Electric | A | — | 2.0~4.0 |

$f_{osc}=440\text{kHz}$

| Prod. No. | Maker | Circuit | Osc. constant | Power supply voltage range |
|---------------|---------------------|---------|---------------|----------------------------|
| CSB440E | Murata Mfg. | A | — | 2.0~4.0 |
| KBR440BK70 | Kyocera corp. | A | — | 2.0~4.0 |
| EFO-A-440K04A | Matsushita Electric | A | — | 2.0~4.0 |

$f_{osc}=455\text{kHz}$

| Prod. No. | Maker | Circuit | Osc. constant | Power supply voltage range |
|---------------|---------------------|---------|---------------|----------------------------|
| CSB455E | Murata Mfg. | A | — | 2.0~4.0 |
| KBR455BK70 | Kyocera corp. | A | — | 2.0~4.0 |
| FCR455K3 | TDK | A | — | 2.0~4.0 |
| EFO-A-455K04A | Matsushita Electric | A | — | 2.0~4.0 |

$f_{osc}=480\text{kHz}$

| Prod. No. | Maker | Circuit | Osc. constant | Power supply voltage range |
|---------------|---------------------|---------|---------------|----------------------------|
| CSB480E | Murata Mfg. | A | — | 2.0~4.0 |
| KBR480BK70 | Kyocera corp. | A | — | 2.0~4.0 |
| FCR480K3 | TDK | A | — | 2.0~4.0 |
| EFO-A-480K04A | Matsushita Electric | A | — | 2.0~4.0 |

fosc=432kHz

| Prod. No. | Maker | Circuit | Osc. constant | Power supply voltage range |
|-----------|-------------|---------|---------------|----------------------------|
| CSB432E | Murata Mfg. | A | — | 2.0~4.0 |

fosc=320kHz

| Prod. No. | Maker | Circuit | Osc. constant | Power supply voltage range |
|-----------|-------------|----------|----------------------|----------------------------|
| CSB320D | Murata Mfg. | B (Note) | C1=100pF C2=100pF | 2.0~4.0 |

(Note) An internal capacitor and external capacitor are required.

4 : Precautions regarding setting of mask options

When setting the mask options for the BU2463 series, the following precautions should be observed.

a : OUT output carrier signal mode

Select the required carrier mode. If using (A ~ C) normal output (no carrier) as the port, select Mode D.

If Mode A is selected, please be aware that there may be times when the HIGH state of the first pulse serves as the seventh clock (normal sixth clock).

b : HALT cancel function

When applying a HALT (oscillation stopped) state, at least one pin should be set to the HALT cancel function YES (Y) state, as a means of cancelling the HALT state. The HALT state will not be cancelled if a LOW state is input to a pin for which the HALT cancel function has been set to NO (N).

A HALT state can also be cancelled by inputting a valid reset signal.

c : S6 and S7 output states in HALT state

In applications where the HALT state is cancelled by shorting an input pin for which the HALT cancel function (see above) has been set (for example, with remote control transmitters), select (A), which produces a LOW state.

This ensures that the HALT state will be cancelled. (The pin will be LOW regardless of the program. However, the state is maintained internally, so recovery occurs following the cancel of the HALT state.)

If pull-up resistance has been added externally, current flows during a HALT state (output is LOW), so other means of retaining the values prior to the HALT state are required, such as selecting (B).

d : Resetting the watchdog timer using the OUT output signal

In applications where the OUT output signal is output periodically, such as in a remote control transmitter, selecting (Y), which resets the timer, can be used effectively.

If (N) is selected, so that the timer is not reset, the program must be designed so that the WDTR instruction is executed periodically (within 2¹³ machine cycles).

e : Capacitors for ceramic resonator circuits

Select whether the capacitor is internal (Y) or not (N), depending on the resonator and oscillation circuit being used.

5 : Precautions when creating programs

When developing programs for the BU2463 series, caution is required concerning the following items.

a : All of the instructions listed below must be stored in the ROM. (As long as they are in the ROM, they do not necessarily have to be used in the software.)

| | | | | |
|-----|-----|------|------|-------|
| CAL | CLA | IYC | LAK | LMAIY |
| LYA | LYM | LAM | NOP | RTN |
| SEO | REO | HALT | WDTR | LAY |
| LMA | IA | DAN | DYN | |

(Note) Of the instructions listed above, those requiring operands must have appropriate values added as the operands.

b : The following instructions should not be used as program start addresses (PAGE = 0, PC = 0).

| | | |
|----|-----|-----|
| BR | SEO | REQ |
|----|-----|-----|

6 : Precautions when evaluating programs

(1) For BU2463

Mass-produced chips can produce operations equivalent to those of evaluation chips (evaluation board : 2403C), but the table below lists differences between the two. If evaluation chips are being used, evaluation

should be carried out keeping these items in mind. Also, other fundamental characteristics are similar, but a sample should be used and testing carried out on mass-produced boards, to make sure the characteristics of final attachment circuits and other components match.

| Class | Item | Mass-production chips (BU2463 series) | Evaluation chip (EV2403C evaluation board) |
|----------------------------|------------------|--|--|
| Option settings | K input | HALT release function (※) can be selected individually for each bit, using mask option. | HALT release function can be selected individually for each bit by setting HALT release function, using setting switches (KHC0 ~ KHC3). |
| | S output | Output state for S6 and S7 in HALT state can be selected, using mask option. | Options for output states in HALT mode are supported by three types of evaluation chips. Note) Of the 4 available options, "S6 in standby, S7 LOW output" is not supported by an evaluation chip. |
| | OUT output | An internal carrier generator enables 4 types of carriers to be selected, using mask option. | An internal carrier generator enables 4 types of carriers to be selected, using carrier setting pins (OP0, OP1). |
| | OSC input/output | Oscillation capacitor can be added between GND pins, using mask option. | Oscillation capacitor options are supported by two types of evaluation chips (used/not used). |
| Electrical characteristics | Reset circuit | Internal Power On Reset circuit | No internal Power On Reset circuit. (External capacitor must be attached.) |
| | Power supply | Connected to 2.0 ~ 4.0 V power supply | [Power to EPROM supplied from separate power supply (5 V)] Connected to 2.5 ~ 4.0 V power supply. [Used with single power supply] Usable voltage range for EPROM must be taken into consideration. Be aware that current consumption increases. |
| | OSC input/output | Oscillation circuit can be configured by mounting ceramic resonator. | Setting selector switch and mounting a ceramic resonator enable configuration of oscillation circuit on evaluation board. In this case, the OSC pin (on emulation cable side) should be open. |
| | | Note) The wiring capacitance and other characteristics are different from those of boards configuring the oscillation circuit, so the oscillation of mass-produced boards must be evaluated. | |

※ HALT release function: If "L" is input to kat HALT, the Half state will be released.

www.DataSheet4U.com

(2) For BU2466

Mass-produced chips can produce operations equivalent to those of evaluation chips (evaluation board : 2403C), but the table below lists differences between the two. If evaluation chips are being used, evaluation should be carried out keeping these items in mind.

Also, other fundamental characteristics are similar, but a sample should be used and testing carried out on mass-produced boards, to make sure the characteristics of final attachment circuits and other components match.

| Class | Item | Mass production chip (BU2466 series) | Evaluation board EV2403C |
|----------------------------|--------------|---|---|
| Option setting | K input | By selecting the mask option, the HALT release function (※) can be selected for each bit. | The HALT release function can be selected for each bit, by using the HALT release function setting pin (KHCO - KHC3). |
| | S output | By selecting the mask option, the output state can be selected for S6 and S7 during HALT. | The output state option during HALT can be accommodated by 3 kinds of ever chips. (Note) Among 4 options "S6 retains the mode," and "S7 low output" cannot be supported by the ever chip. |
| | OUT output | A carrier generator is incorporated so that 4-kinds of carriers can be selected by selecting mask option. | Carrier generator is built in, so 4 kinds of carriers can be selected by the carrier setting pins (OP0 and OP1). |
| | OSC I/O | By selecting the mask option, oscillation capacitors can be added before grounds. | The options of oscillation capacitor can be accommodated depending on the 2-kinds of ever chips. |
| Electrical characteristics | S4,S5 output | None | Do not use pins in the open state. |
| | Power supply | Connect a supply voltage of between 2.0 V and 4.0 V. | [A power voltage of 5 V for EPROW should be supplied by a separated source.] Connect to a power voltage of between 2.5 V and 4.0 V. [Use single power source] The power supply voltage for EPROW should be considered. Note that current consumption increases. |
| | OSC I/O | | By selecting the setting switch and mounting ceramic oscillator, oscillation circuit can be configured on the ever board. In such case the OSC pin (on the side of the emulation cable .) becomes open. |
| | | Note: The wiring capacity of the board that consists of an oscillation circuit is different from that of quantity production circuit board, so to oscillation evaluation using the quantity production board must be carried out. | |

(※) HALT release function: If "L" is input to K at HALT, the HALT state will be released.

7 : Application circuit example

This shows a typical application example using the BU2458 as a base chip in a remote control encoder.

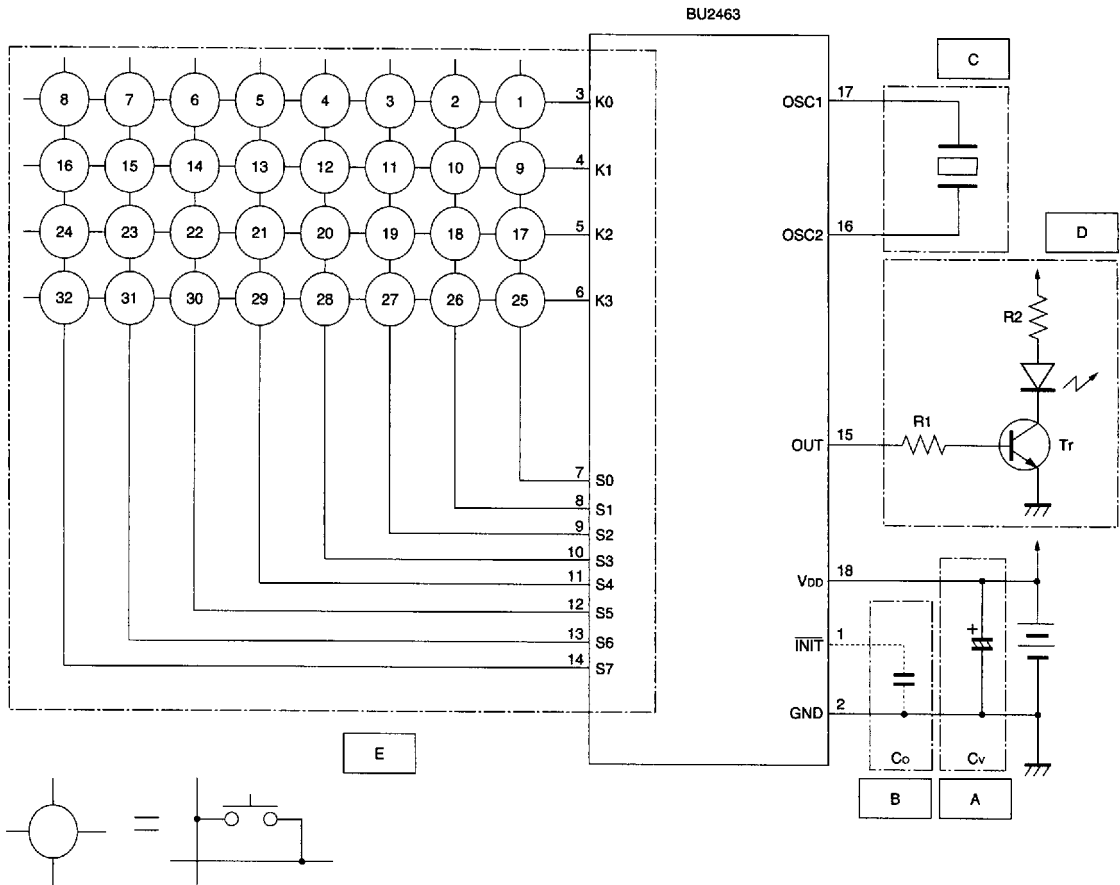

Fig. 26 Application circuit example (32-key remote control unit)

The following is a guide to peripheral circuits (A to E in the above diagram).

- A : Power supply circuit (page 15)
- B : Initial reset circuit (page 1)
- C : Oscillation circuit (pages 2 ~ 4)
- D : Infrared LED drive circuit (pages 16 ~ 17)
- E : Key scan circuit (pages 18 ~ 19)

(Note) There are no RC or RD pins in the BU2466.

● Operation notes

Although the application circuit example shown above is recommendable, it is requested that the circuit characteristics should be confirmed carefully. When using the circuit with the external circuit constant changed, consider the marginal difference of the static characteristics and transient characteristics about the attachments including Rohm ICs.

Please note that we have not confirmed about the patent.

A : Power supply circuit

If large current flows to the circuit, such as in infrared LED drive circuits, and there is high wiring impedance on the board and high power supply impedance (in cases where the battery wears down particularly quickly because the equivalent impedance of the battery is too high), the power supply voltage fluctuates, and the IC may malfunction because it is operating outside of the operating power supply voltage range.

To suppress fluctuation in the power supply voltage and assure stable operation, an electrolytic capacitor should be connected between V_{DD} and GND, as close to the IC pin as possible.

Depending on the settings entered for specifications such as the signal arrival distance and usage power supply voltage range, as well as conditions such as the type of battery used and the board design, a capacitance of 47 ~ 100 μF should be provided, with the appropriate value being determined through experimentation. If it is not possible to attach a large capacitor sufficiently close to the IC pin because of the mounting space or other considerations, a smaller capacitor (0.01 ~ 0.1 μF) may be added in close proximity to provide supplemental capacitance.

D : Infrared LED drive (OUT pin application) circuits
An infrared LED drive circuit can be configured by adding a single external NPN Tr to the OUT output.

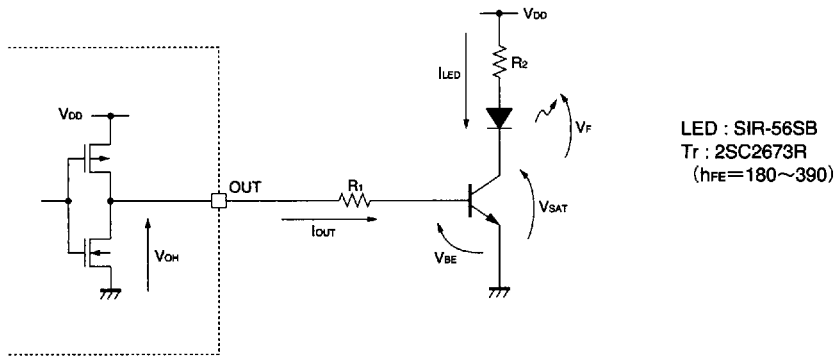

Fig. 27 Example of OUT pin attachment circuit

The following show examples of how the various constants in the circuit in Figure 27 are determined.

a : Setting the LED drive current (I_{LED})

This is set with the type of LED and the arrival distance of the infrared beam in mind.

Using an SIR-56SB as the LED, at V_{DD} = 3V, designing a circuit with a target value of I_{LED} = 700mA involves the following calculation examples.

b : Setting R₁

The Tr must be put in overdrive and a base current value must be set that cannot fail to cause saturation, taking dispersion and temperature characteristics into consideration.

Assuming an overdrive factor of K, the base current I_{OUT} is determined as shown in equation (1).

In equation (1), if h_{FE} = 270 typ. (see Tr specifications) and I_{LED} = 700mA, then setting K = 5 produces the following value for I_{OUT}.

$$I_{OUT} = \frac{5 \times 700\text{mA}}{270} \cong 13\text{mA}$$

Caution is required, because if K is excessively large, the accumulation time for Tr will be longer, resulting in a longer ON time.

Assuming an OUT output HIGH voltage of V_{OH} and a Tr base - emitter voltage of V_{BE}, resistance R₁ is determined by equation (2).

$$R_1 = \frac{V_{OH} - V_{BE}}{I_{OUT}} \dots \dots \dots (2)$$

$$I_{OUT} = \frac{K \times I_{LED}}{h_{FE}} \dots \dots \dots (1)$$

In equation (2), if $V_{OH} = 2.2V$ (at $I_{OUT} = 13mA$: see Figure 9) and the V_{BE} of Tr = $0.8V$, the following equation results.

$$R_1 = \frac{2.15 - 0.8}{13 \times 10^{-3}} = 103.8 (\Omega)$$

As a result, a value of $R_1 \cong 110 (\Omega)$ is appropriate. (At this point, it is assumed that I_{OUT} will fluctuate between 12.0mA and 14.0mA because of fluctuation of the IC.)

c : Setting R_2

Resistance R_2 is expressed by equation (3), assuming the saturation voltage when Tr is ON ($I_{LED} = 700mA$) is V_{SAT} and the forward voltage of the infrared LED is V_F .

$$R_2 = \frac{V_{DD} - V_F - V_{SAT}}{I_{LED}} \dots \dots (3)$$

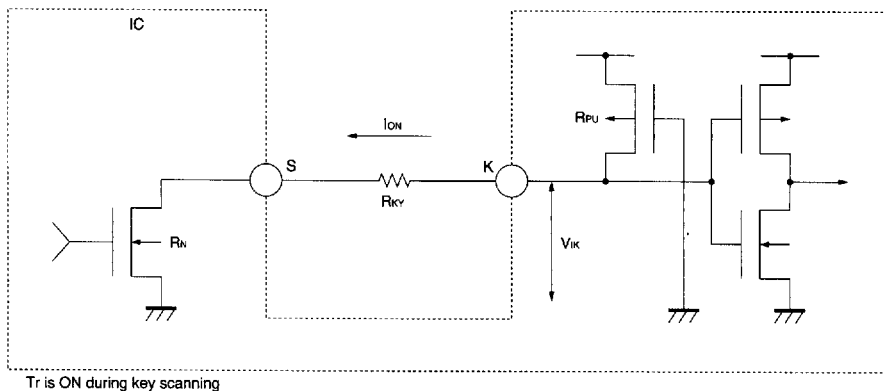

Fig. 28 Key scan circuit (equivalent circuit when key switch is ON)

When configuring a key scan circuit, the following precautions should be observed.

If a material with high ON resistance (R_{KY}) such as conductive rubber is used as the key switch, the input voltage V_{IK} to the K (R) pin will only drop as far as differential voltage between $R_{KY} + R_N$ and R_{PU} (see equation 4), even when a key is pressed. Key scanning cannot be carried out properly if this becomes higher than the K (R) input LOW voltage (V_{ILK}). Therefore, the design should ensure that R_{KY} stays lower than the value indicated below.

(R_{KY} indicates the resistance value between the two IC pins when the key is on, including the wiring resistance.)

The following calculation is carried out under the conditions $V_{DD} = 3V$ and $T_a = 25^\circ C$.

In equation (3), if $V_{SAT} = 0.25V$ and $V_F = 1.65V$ (see the specifications for Tr and LED), the following value results.

$$R_2 = \frac{3.0 - 1.65 - 0.25}{700 \times 10^{-3}} = 1.57 (\Omega)$$

Based on this result, $R_2 \cong 1.6 \Omega$ is an appropriate value. (At this point, V_{SAT} fluctuates because of the base current value (I_{OUT}) of (1), but since there is sufficient saturation, the fluctuation of V_{SAT} can be suppressed to around 0.1V or less. (See the specifications for Tr.)

E : Key scan circuit

The key scan circuit is configured as shown in Figure 28. (S output - K input)

Assuming that $R_N \ll R_{KY}$ and R_{PU} :

$$V_{IK} = \frac{R_{KY} + R_N}{R_{PU} + R_{KY} + R_N} \times V_{DD} \cong \frac{R_{KY}}{R_{PU} + R_{KY}} \dots (4)$$

$V_{IK} \leq V_{IL} (\text{max.})$ is the condition required in order for key scanning to be carried out correctly (the input pin voltage must be below the maximum input LOW voltage noted in the specifications). This gives us the following :

$$V_{IK} = \frac{R_{KY}}{R_{PU} + R_{KY}} \times V_{DD} \leq V_{IL} (\text{Max.}) \dots (5)$$

In equation (5), a worst-case scenario is assumed in which R_{PU} will be the minimum value (see specifications), so the setting range which determines R_{KY} is as follows :

$$R_{KY} \leq \frac{R_{PU} (\text{Min.}) \times V_{IL}}{V_{DD} - V_{IL}} \cong \frac{60k \times 0.9}{3 - 0.9} = 25.7 (\Omega)$$

www.DataSheet4U.com

In addition to the above, if keys are arranged in serial order and Di is inserted, please be aware that conditions will deteriorate further. We recommend that operation be evaluated using an actual board.

Also, aside from an increase in the input voltage caused by the resistance of the keys and wiring, if the circuit has a capacitance such as wiring, the effects of that capacitance must be taken into consideration as well.

This capacitance causes the rise and fall times of the key scan signals to be slower, throwing the key scan timing off far enough that the level does not reach the LOW state, or a HIGH state is not reached before the next input timing begins. These situations can make it impossible to obtain accurate key scan results. To prevent such problems, the program design must ensure that key pulses are output for a longer period of time than the delay time caused by the wiring impedance. Also, if using a program developed by Rohm, the initial delay timing (a and b in Figure 29) of the finished program must be within $200 \mu\text{s}$. (Rohm key scan programs are standardized to that timing.)

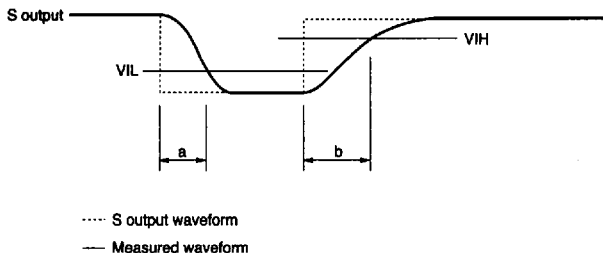
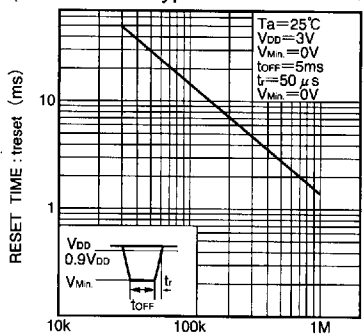

Fig. 29 Key scan signal and input timing

● Electrical characteristic curves

(Data indicate typical values and not guaranteed (rated) values.)



EXTERNAL CLOCK FREQUENCY : f_{ck} (Hz)
(Note: There is no Power On Reset circuit in the BU2466.)

Fig. 30 Frequency characteristic for BU2463 reset time

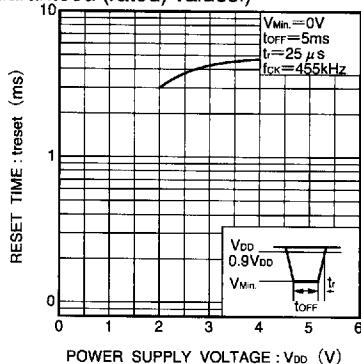

POWER SUPPLY VOLTAGE : V_{DD} (V)

Fig. 31 Power supply voltage characteristic for BU2466 reset time

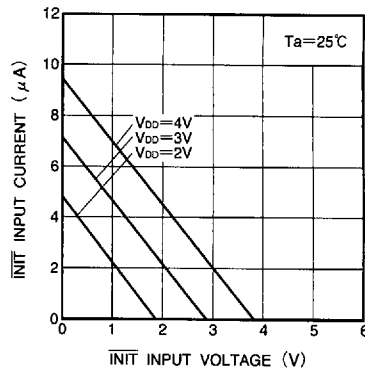

Fig. 32 \overline{INIT} input current characteristic (typical values)

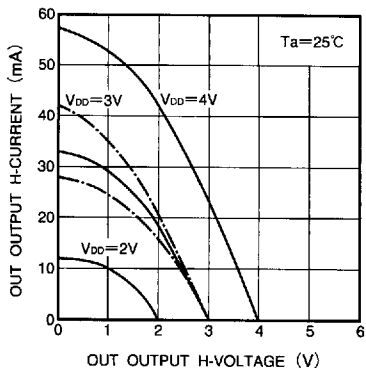

Fig. 33 OUT output "H" current characteristic (typical values)

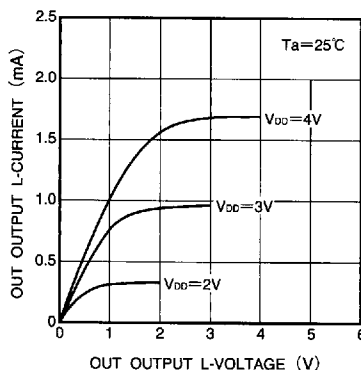

Fig. 34 OUT output "L" current characteristic (typical values)

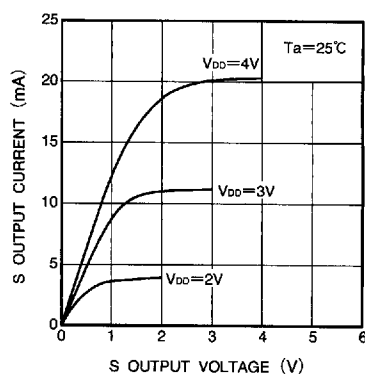

Fig. 35 S output current characteristic (typical values)

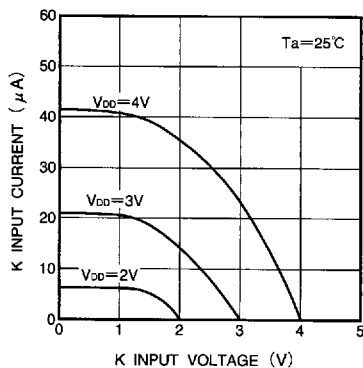

Fig. 36 K input current characteristic (typical values)

For simple-key remote controllers

Application-specific microcontrollers

www.DataSheet4U.com

● External dimensions (Units: mm)

BU2463

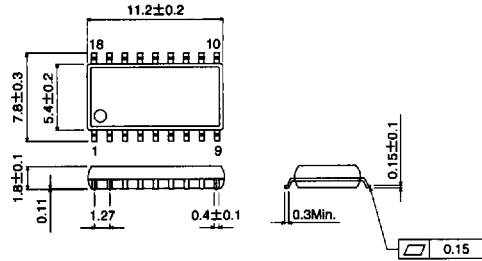

SOP18

BU2464

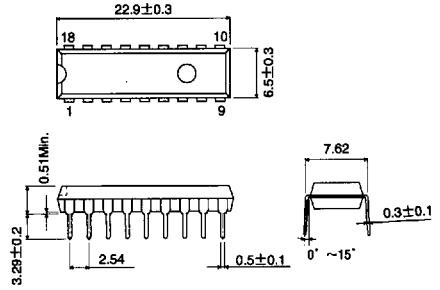

DIP18

BU2465

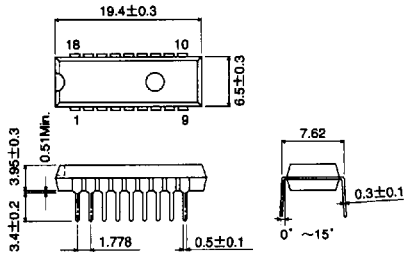

SDIP18

BU2466

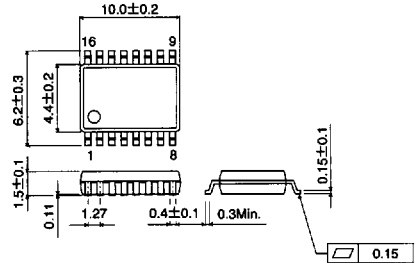

SOP16