

◆Si APN

◆RoHS COMPLIANT

## 1. APPLICATION

Charger、 Computer aided power、  
and Switch-mode power supplies

## 2. FEATURES

- High voltage capability
- Features of good high temperature
- High switching speed

## 3. PACKAGE

TO-126F

## 4. Electrical Characteristics

### 4.1 Absolute Maximum Ratings

$T_{amb}=25^{\circ}\text{C}$  unless specified

PARAMETER		SYMBOL	VALUE	UNIT
Collector-Base Voltage		$V_{CBO}$	1400	V
Collector-Emittor Voltage		$V_{CEO}$	800	V
Emittor- Base Voltage		$V_{EBO}$	9	V
Collector Current		$I_C$	1.5	A
Power Dissipation	$T_a=25^{\circ}\text{C}$	$P_{tot}$	1.25	W
	$T_c=25^{\circ}\text{C}$		20	
Junction Temperature		$T_j$	150	$^{\circ}\text{C}$
Storage Temperature		$T_{stg}$	-55~150	$^{\circ}\text{C}$

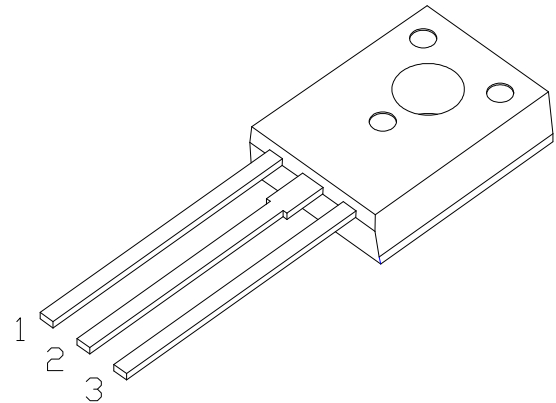

1 Base(B) 2 Collector(C) 3 Emitter(E)

### 4.2 Electrical Parameter

$T_{amb}=25^{\circ}\text{C}$  unless specified

PARAMETER	SYMBOL	TEST CONDITION	VALUE			UNIT
			MIN	TYP	MAX	
Collector-Base Voltage	$BV_{CBO}$	$I_C=1\text{mA}, I_E=0$	1400			V
Collector-Emittor Voltage	$BV_{CEO}$	$I_C=1\text{mA}, I_B=0$	800			V
Emittor-Base Voltage	$BV_{EBO}$	$I_E=1\text{mA}, I_C=0$	9			V
Collector-Base Cutoff Current	$I_{CBO}$	$V_{CB}=1400\text{V}, I_E=0$			10	$\mu\text{A}$
Collector-Emittor Cutoff Current	$I_{CEO}$	$V_{CE}=800\text{V}, I_B=0$			20	$\mu\text{A}$
Emittor-Base Cutoff Current	$I_{EBO}$	$V_{EB}=9\text{V}, I_C=0$			10	$\mu\text{A}$
DC Current Gain	$h_{FE}^*$	$V_{CE}=5\text{V}, I_C=1\text{mA}$	8			
		$V_{CE}=5\text{V}, I_C=100\text{mA}$	15		30	
Collector-Emittor Saturation Voltage	$V_{CE\text{ sat}}^*$	$I_C=1\text{A}, I_B=0.5\text{A}$			0.6	V
Base-Emittor Saturation Voltage	$V_{BE\text{ sat}}^*$	$I_C=1\text{A}, I_B=0.5\text{A}$			1.2	V
Rising Time	$t_r$	$I_C=500\text{mA} \quad (UI9600)$			3.0	$\mu\text{s}$
Falling Time	$t_f$				3.0	$\mu\text{s}$
Storage Time	$t_s$		1.5		3.5	$\mu\text{s}$
Typical Frequency	$f_T$	$V_{CE}=20\text{V}, I_C=20\text{mA}, f=1\text{MHz}$	5			MHz

\*: Pulse test  $t_p \leq 300 \mu\text{s}, \delta \leq 2\%$

## 5. Characteristic Curve

Fig1 SOA (DC)

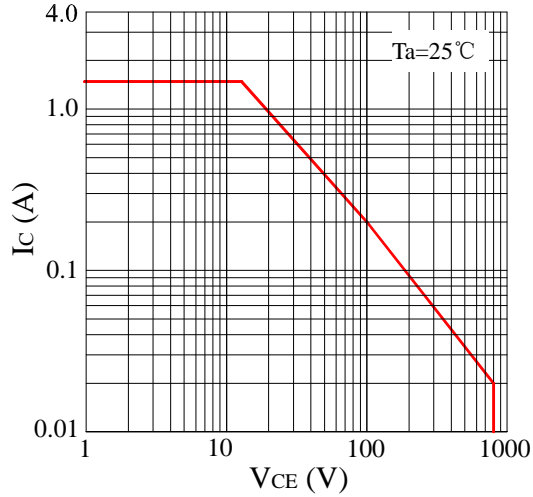

Fig2 Ptot - T

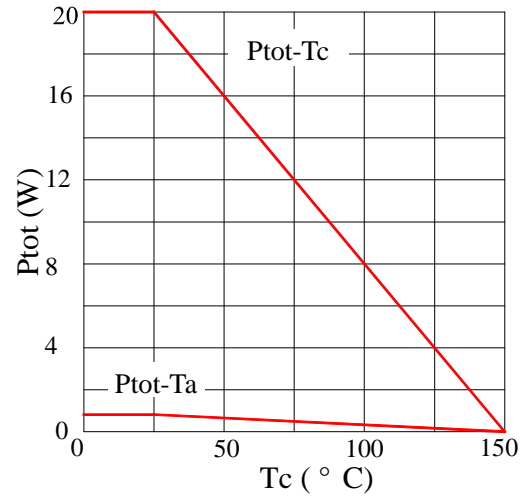

Fig3 Static Characteristic

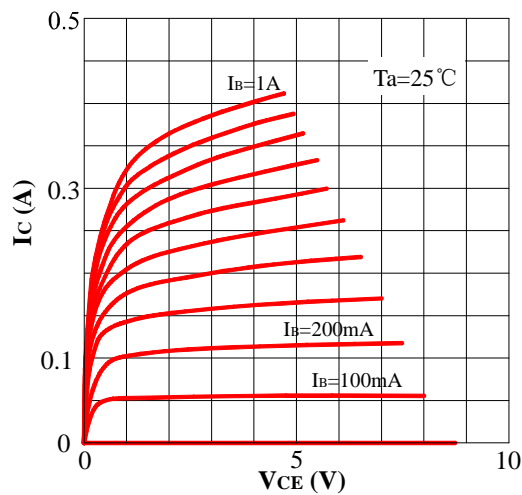

Fig4 hFE-Ic

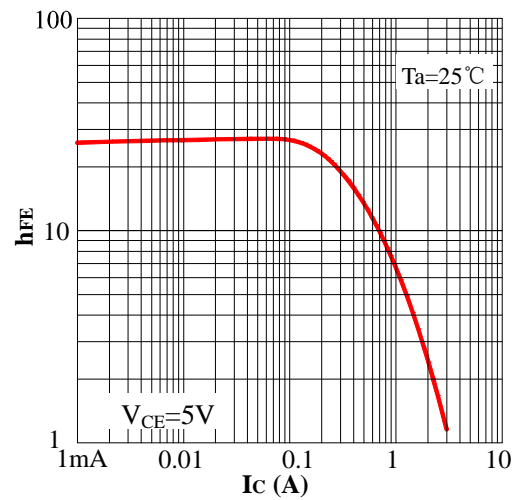

Fig5 V<sub>CEsat</sub>-I<sub>C</sub>

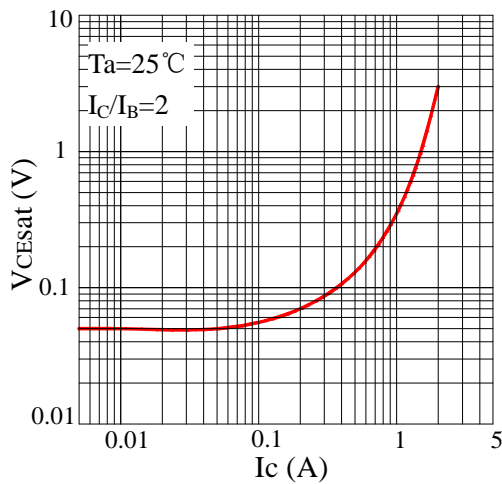
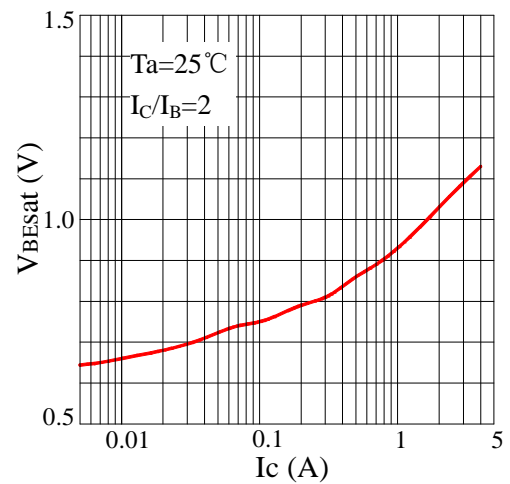

Fig6 V<sub>BESat</sub>-I<sub>C</sub>



## 6. Package Dimentions(Unit: mm)

T0-126F

