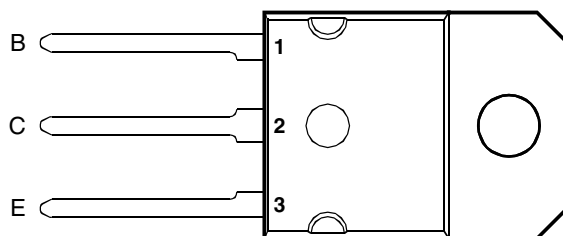

BOURNS®

- Rugged Triple-Diffused Planar Construction
- 900 Volt Blocking Capability

SOT-93 PACKAGE
(TOP VIEW)

Pin 2 is in electrical contact with the mounting base.

MDTRAAA

absolute maximum ratings at 25°C case temperature (unless otherwise noted)

RATING		SYMBOL	VALUE	UNIT
Collector-base voltage ($I_E = 0$)	BU426	V_{CB0}	800	V
	BU426A		900	
Collector-emitter voltage ($V_{BE} = 0$)	BU426	V_{CES}	800	V
	BU426A		900	
Collector-emitter voltage ($I_B = 0$)	BU426	V_{CEO}	375	V
	BU426A		400	
Continuous collector current		I_C	6	A
Peak collector current (see Note 1)		I_{CM}	10	A
Continuous base current		I_B	+2, -0.1	A
Peak base current (see Note 1)		I_{BM}	± 3	A
Continuous device dissipation at (or below) 50°C case temperature		P_{tot}	70	W
Operating junction temperature range		T_j	-65 to +150	°C
Storage temperature range		T_{stg}	-65 to +150	°C

NOTE 1: This value applies for $t_p \leq 2$ ms, duty cycle $\leq 2\%$.**PRODUCT INFORMATION**AUGUST 1978 - REVISED SEPTEMBER 2002
Specifications are subject to change without notice.

BU426, BU426A

NPN SILICON POWER TRANSISTORS

BOURNS®
electrical characteristics at 25°C case temperature (unless otherwise noted)

PARAMETER	TEST CONDITIONS			MIN	TYP	MAX	UNIT
$V_{CE(sus)}$ Collector-emitter sustaining voltage	$I_C = 100 \text{ mA}$	$L = 25 \text{ mH}$	(see Note 2)	BU426 BU426A	375 400		V
I_{CES} Collector-emitter cut-off current	$V_{CE} = 800 \text{ V}$	$V_{BE} = 0$		BU426		1	mA
	$V_{CE} = 900 \text{ V}$	$V_{BE} = 0$		BU426A		1	
	$V_{CE} = 800 \text{ V}$	$V_{BE} = 0$	$T_C = 125^\circ\text{C}$	BU426		2	
	$V_{CE} = 900 \text{ V}$	$V_{BE} = 0$	$T_C = 125^\circ\text{C}$	BU426A		2	
I_{EBO} Emitter cut-off current	$V_{EB} = 10 \text{ V}$	$I_C = 0$				10	mA
h_{FE} Forward current transfer ratio	$V_{CE} = 5 \text{ V}$	$I_C = 0.6 \text{ A}$	(see Notes 3 and 4)		30	60	
$V_{CE(sat)}$ Collector-emitter saturation voltage	$I_B = 0.5 \text{ A}$	$I_C = 2.5 \text{ A}$	(see Notes 3 and 4)			1.5	V
	$I_B = 1.25 \text{ A}$	$I_C = 4 \text{ A}$				3	
$V_{BE(sat)}$ Base-emitter saturation voltage	$I_B = 0.5 \text{ A}$	$I_C = 2.5 \text{ A}$	(see Notes 3 and 4)			1.4	V
	$I_B = 1.25 \text{ A}$	$I_C = 4 \text{ A}$				1.6	

NOTES: 2. Inductive loop switching measurement.

3. These parameters must be measured using pulse techniques, $t_p = 300 \mu\text{s}$, duty cycle $\leq 2\%$.

4. These parameters must be measured using voltage-sensing contacts, separate from the current carrying contacts.

thermal characteristics

PARAMETER	MIN	TYP	MAX	UNIT
$R_{\theta JC}$ Junction to case thermal resistance			1.1	$^\circ\text{C/W}$

resistive-load-switching characteristics at 25°C case temperature (unless otherwise noted)

PARAMETER	TEST CONDITIONS †			MIN	TYP	MAX	UNIT
t_{on} Turn on time	$I_C = 2.5 \text{ A}$ $V_{CC} = 250 \text{ V}$	$I_{B(on)} = 0.5 \text{ A}$ (see Figures 1 and 2)	$I_{B(off)} = -1 \text{ A}$		0.3	0.6	μs
t_s Storage time					2	3.5	μs
t_f Fall time					0.15		μs
t_f Fall time	$I_C = 2.5 \text{ A}$ $V_{CC} = 250 \text{ V}$	$I_{B(on)} = 0.5 \text{ A}$ $T_C = 95^\circ\text{C}$	$I_{B(off)} = -1 \text{ A}$		0.2	0.75	μs

† Voltage and current values shown are nominal; exact values vary slightly with transistor parameters.

PRODUCT INFORMATION

AUGUST 1978 - REVISED SEPTEMBER 2002
Specifications are subject to change without notice.



PARAMETER MEASUREMENT INFORMATION

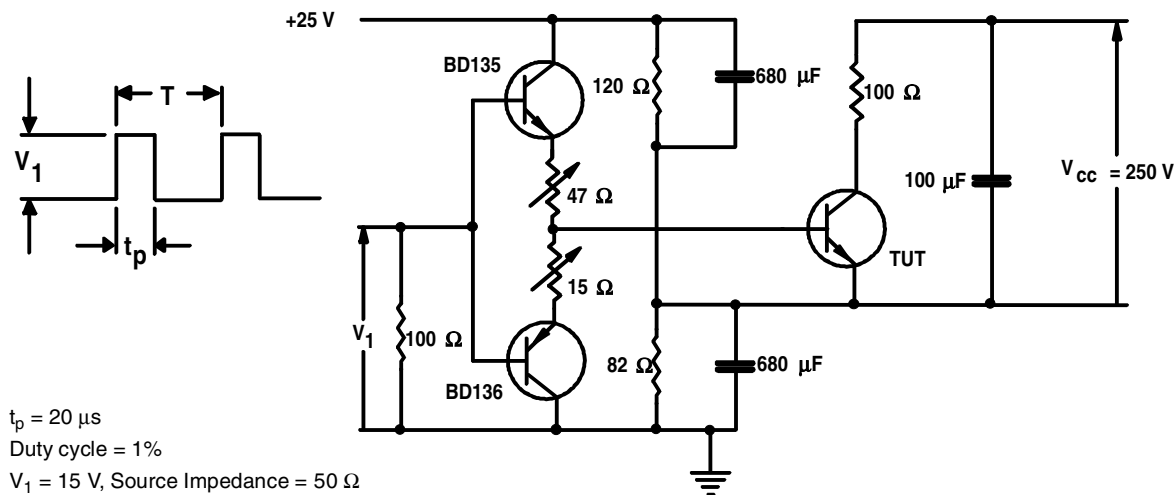

Figure 1. Resistive-Load Switching Test Circuit

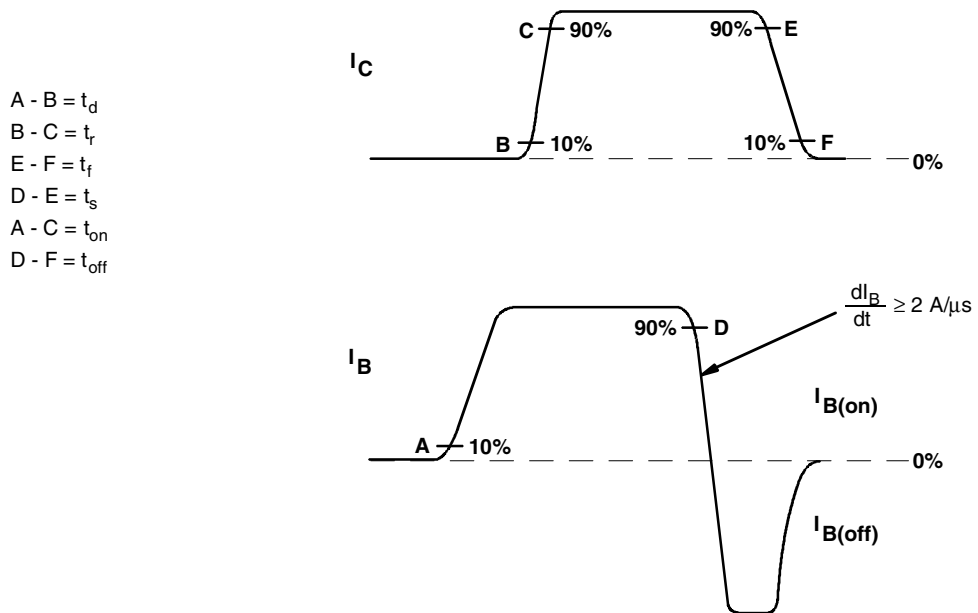

Figure 2. Resistive-Load Switching Waveforms

PRODUCT INFORMATION

AUGUST 1978 - REVISED SEPTEMBER 2002
Specifications are subject to change without notice.

TYPICAL CHARACTERISTICS

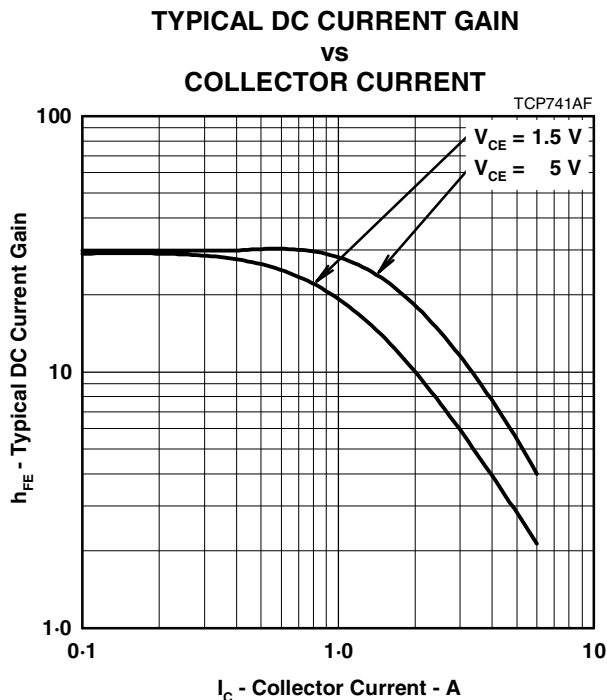

Figure 3.

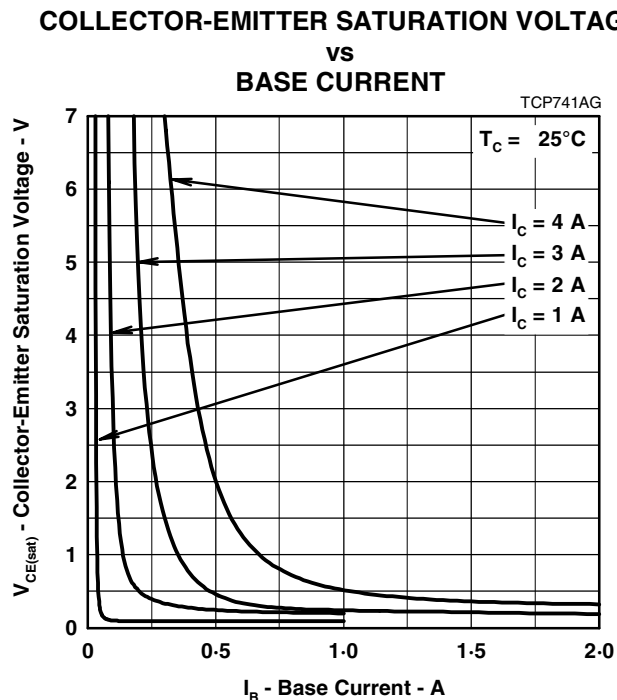

Figure 4.

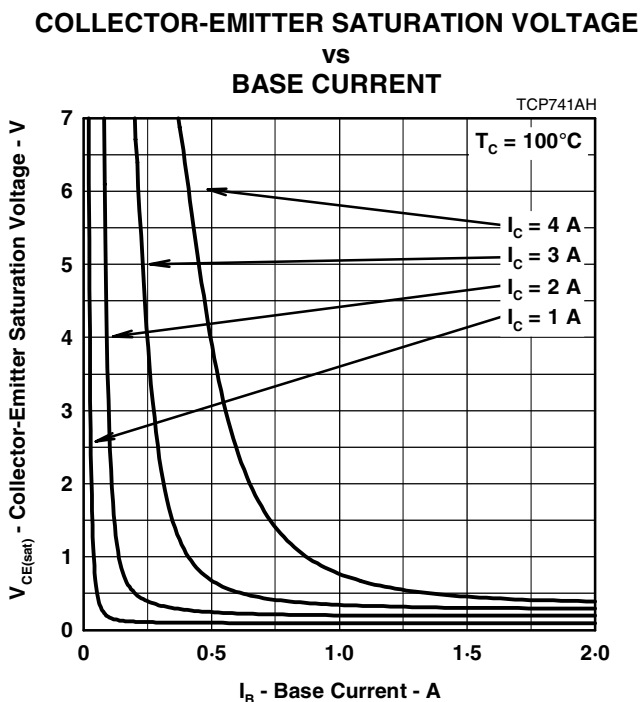

Figure 5.

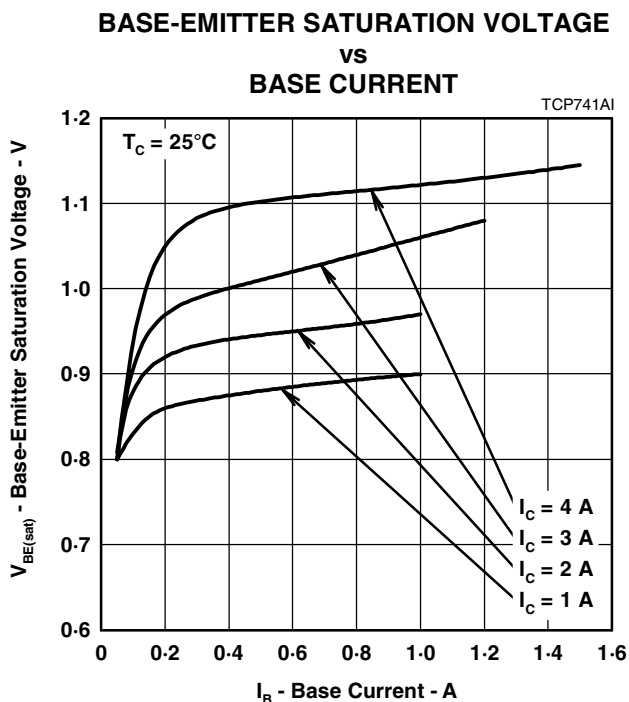

Figure 6.



MAXIMUM SAFE OPERATING REGIONS

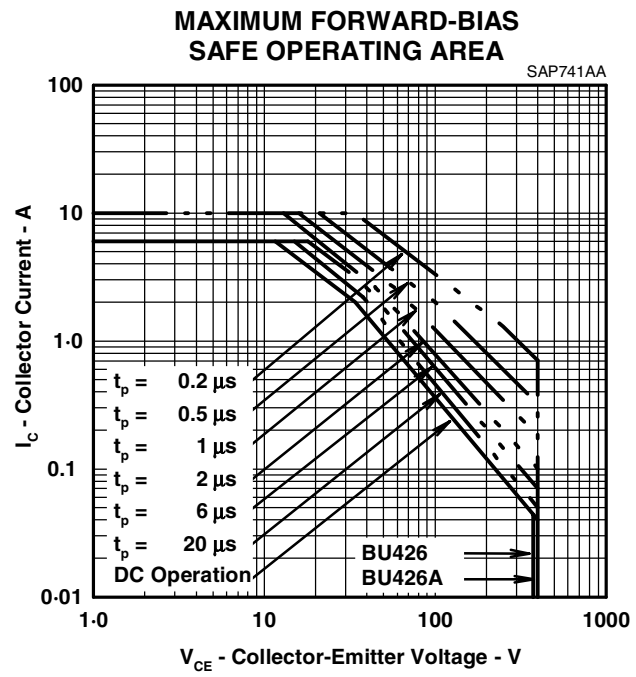

Figure 7.

PRODUCT INFORMATION

AUGUST 1978 - REVISED SEPTEMBER 2002
Specifications are subject to change without notice.

BU426, BU426A NPN SILICON POWER TRANSISTORS

BOURNS®

MECHANICAL DATA

SOT-93

3-pin plastic flange-mount package

This single-in-line package consists of a circuit mounted on a lead frame and encapsulated within a plastic compound. The compound will withstand soldering temperature with no deformation, and circuit performance characteristics will remain stable when operated in high humidity conditions. Leads require no additional cleaning or processing when used in soldered assembly.

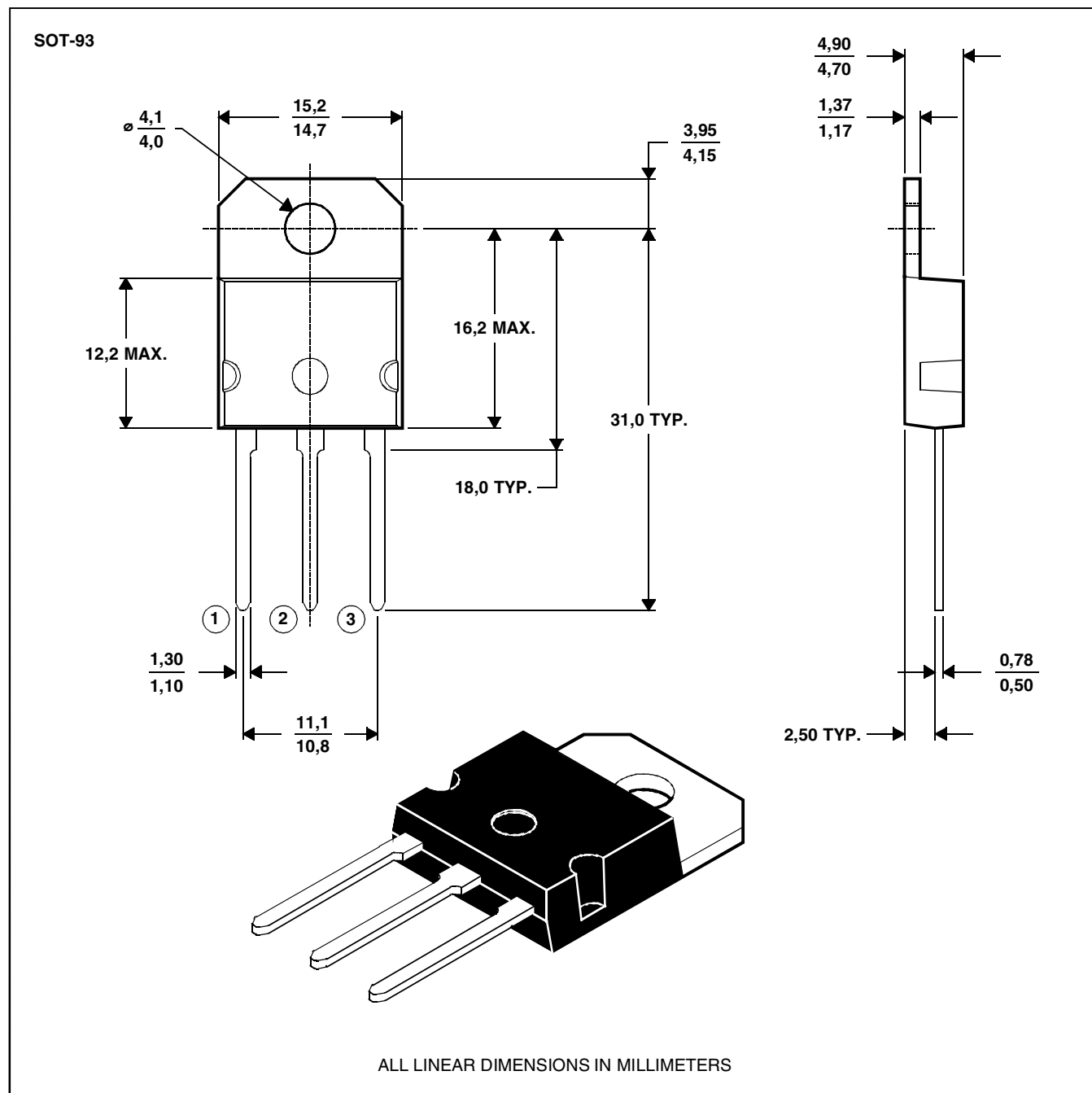

NOTE A: The centre pin is in electrical contact with the mounting tab.

MDXXAW

PRODUCT INFORMATION

AUGUST 1978 - REVISED SEPTEMBER 2002
Specifications are subject to change without notice.