



BU208A BU508A/BU508AFI

HIGH VOLTAGE FAST-SWITCHING NPN POWER TRANSISTORS

- STMicroelectronics PREFERRED SALESTYPES
- HIGH VOLTAGE CAPABILITY (> 1500 V)
- FULLY INSULATED PACKAGE (U.L. COMPLIANT) FOR EASY MOUNTING

APPLICATIONS:

- HORIZONTAL DEFLECTION FOR COLOUR TV

DESCRIPTION

The BU208A, BU508A and BU508AFI are manufactured using Multi-epitaxial Mesa technology for cost-effective high performance and use a Hollow Emitter structure to enhance switching speeds.

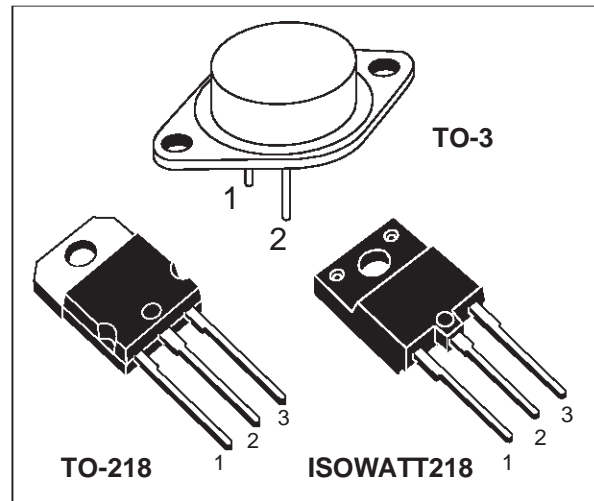

INTERNAL SCHEMATIC DIAGRAM

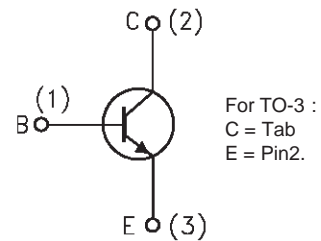

SC06960

ABSOLUTE MAXIMUM RATINGS

Symbol	Parameter	Value			Unit
V_{CES}	Collector-Emitter Voltage ($V_{BE} = 0$)	1500			V
V_{CEO}	Collector-Emitter Voltage ($I_B = 0$)	700			V
V_{EBO}	Emitter-Base Voltage ($I_C = 0$)	10			V
I_C	Collector Current	8			A
I_{CM}	Collector Peak Current ($t_p < 5$ ms)	15			A
		BU208A	BU508A	BU508AFI	
		TO - 3	TO - 218	ISOWATT218	
P_{tot}	Total Dissipation at $T_c = 25$ °C	150	125	50	W
V_{isol}	Insulation Withstand Voltage (RMS) from All Three Leads to External Heatsink			2500	V
T_{stg}	Storage Temperature	-65 to 175	-65 to 150	-65 to 150	°C
T_j	Max. Operating Junction Temperature	175	150	150	°C

BU208A / BU508A / BU508AFI

THERMAL DATA

			TO-3	TO-218	ISOWATT218	
$R_{thj-case}$	Thermal Resistance Junction-case	Max	1	1	2.5	°C/W

ELECTRICAL CHARACTERISTICS ($T_{case} = 25\text{ }^{\circ}\text{C}$ unless otherwise specified)

Symbol	Parameter	Test Conditions	Min.	Typ.	Max.	Unit
I_{CES}	Collector Cut-off Current ($V_{BE} = 0$)	$V_{CE} = 1500\text{ V}$ $V_{CE} = 1500\text{ V}$ $T_C = 125\text{ }^{\circ}\text{C}$			1 2	mA mA
I_{EBO}	Emitter Cut-off Current ($I_C = 0$)	$V_{EB} = 5\text{ V}$			100	μA
$V_{CEO(sus)*}$	Collector-Emitter Sustaining Voltage ($I_B = 0$)	$I_C = 100\text{ mA}$	700			V
V_{EBO}	Emitter Base Voltage ($I_C = 0$)	$I_E = 10\text{ mA}$	10			V
$V_{CE(sat)*}$	Collector-Emitter Saturation Voltage	$I_C = 4.5\text{ A}$ $I_B = 2\text{ A}$			1	V
$V_{BE(sat)*}$	Base-Emitter Saturation Voltage	$I_C = 4.5\text{ A}$ $I_B = 2\text{ A}$			1.3	V
t_s t_f	INDUCTIVE LOAD Storage Time Fall Time	$I_C = 4.5\text{ A}$ $h_{FE} = 2.5$ $V_{CC} = 140\text{ V}$ $L_C = 0.9\text{ mH}$ $L_B = 3\text{ }\mu\text{H}$		7 550		μs ns
f_T	Transition Frequency	$I_C = 0.1\text{ A}$ $V_{CE} = 5\text{ V}$ $f = 5\text{ MHz}$		7		MHz

* Pulsed: Pulse duration = 300 μs , duty cycle 1.5 %

Safe Operating Area (TO-3)

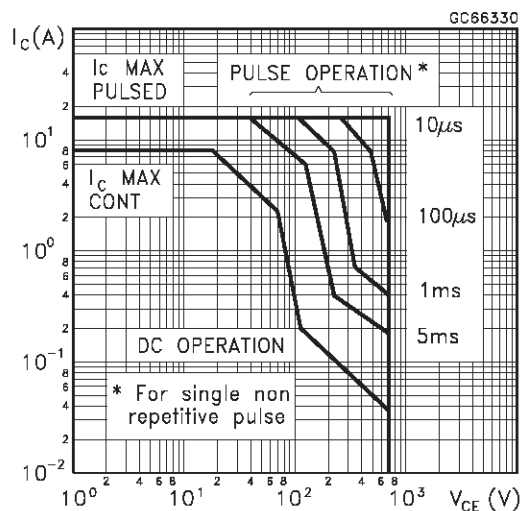

Safe Operating Areas (TO-218/ISOWATT218)

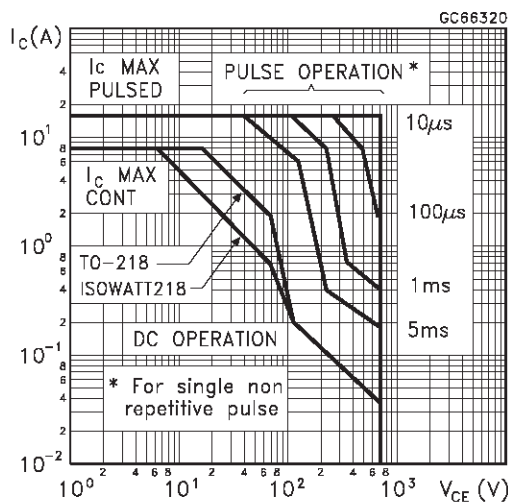

Derating Curves (TO-3)

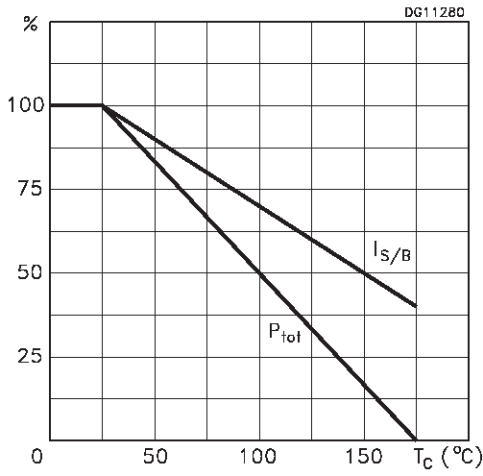

Derating Curves (TO-218/ISOWATT218)

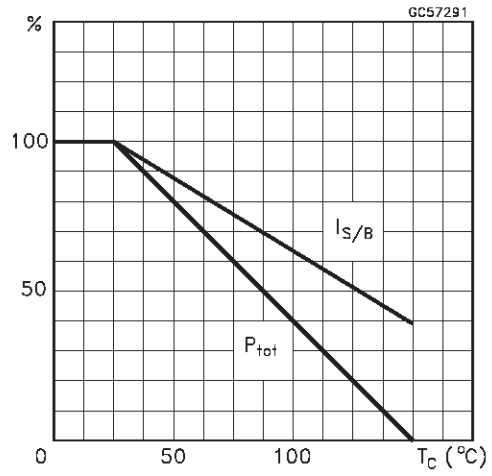

DC Current Gain

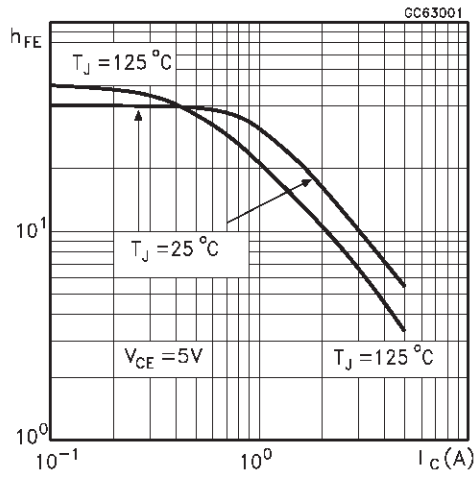

Collector Emitter Saturation Voltage

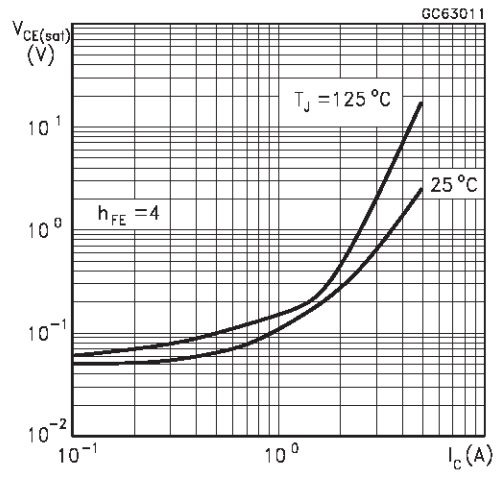

Base Emitter Saturation Voltage

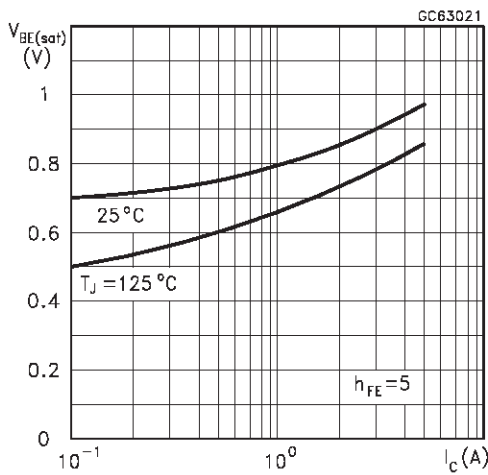

Switching Time Inductive Load

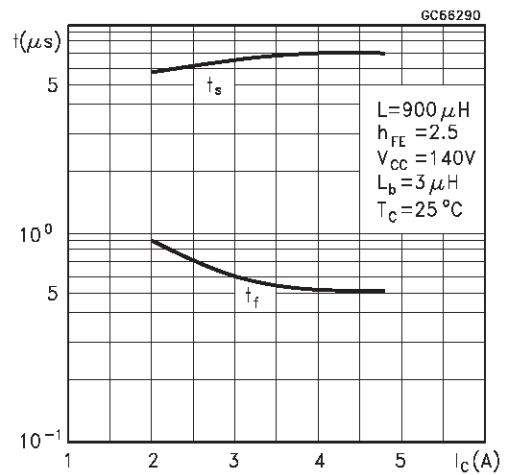

Switching Time Inductive Load

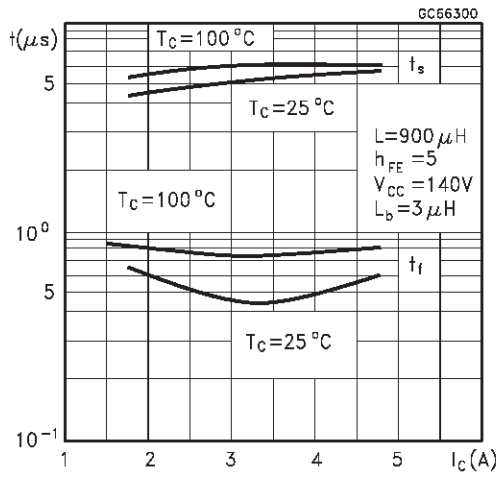
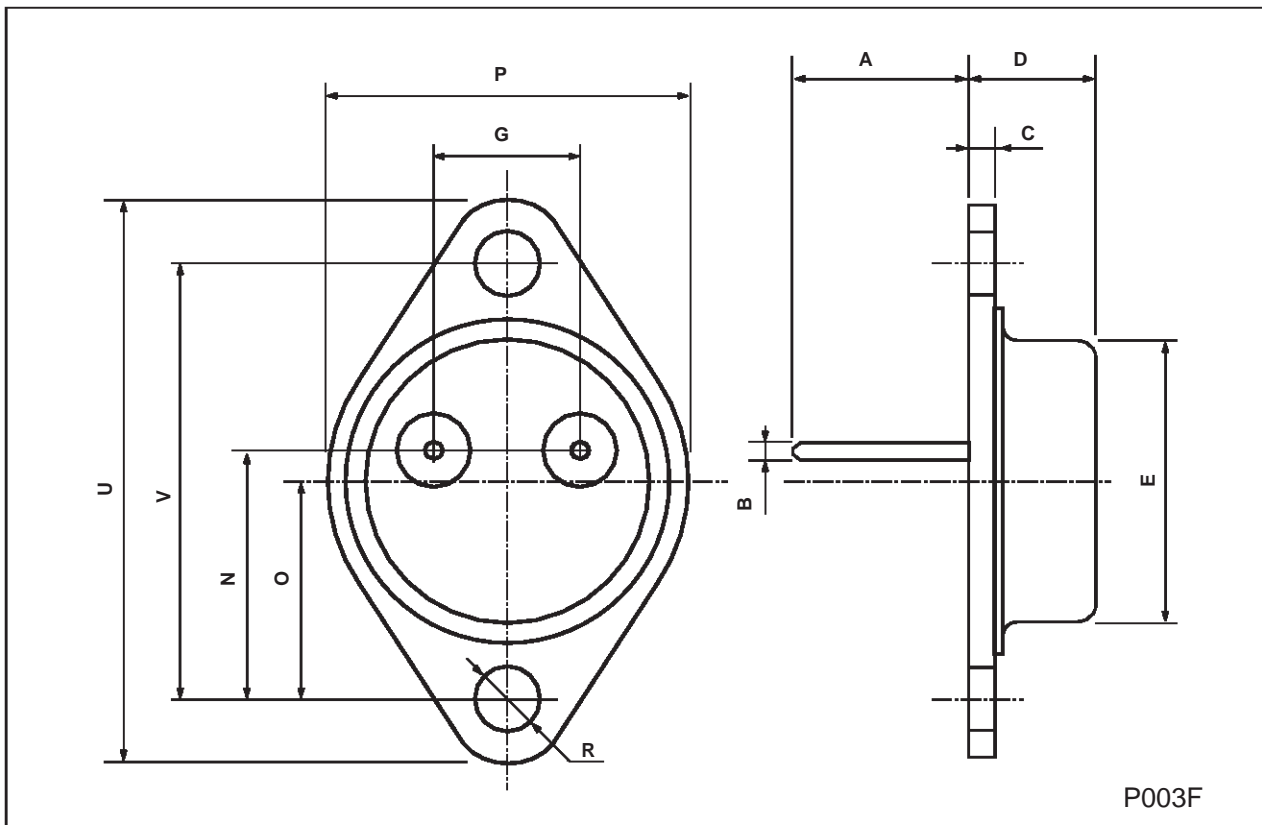

Figure 1: Inductive Load Switching Test Circuit.



TO-3 MECHANICAL DATA

DIM.	mm			inch		
	MIN.	TYP.	MAX.	MIN.	TYP.	MAX.
A	11.00		13.10	0.433		0.516
B	0.97		1.15	0.038		0.045
C	1.50		1.65	0.059		0.065
D	8.32		8.92	0.327		0.351
E	19.00		20.00	0.748		0.787
G	10.70		11.10	0.421		0.437
N	16.50		17.20	0.649		0.677
P	25.00		26.00	0.984		1.023
R	4.00		4.09	0.157		0.161
U	38.50		39.30	1.515		1.547
V	30.00		30.30	1.187		1.193



TO-218 (SOT-93) MECHANICAL DATA

DIM.	mm			inch		
	MIN.	TYP.	MAX.	MIN.	TYP.	MAX.
A	4.7		4.9	0.185		0.193
C	1.17		1.37	0.046		0.054
D		2.5			0.098	
E	0.5		0.78	0.019		0.030
F	1.1		1.3	0.043		0.051
G	10.8		11.1	0.425		0.437
H	14.7		15.2	0.578		0.598
L2	-		16.2	-		0.637
L3		18			0.708	
L5	3.95		4.15	0.155		0.163
L6		31			1.220	
R	-		12.2	-		0.480
Ø	4		4.1	0.157		0.161

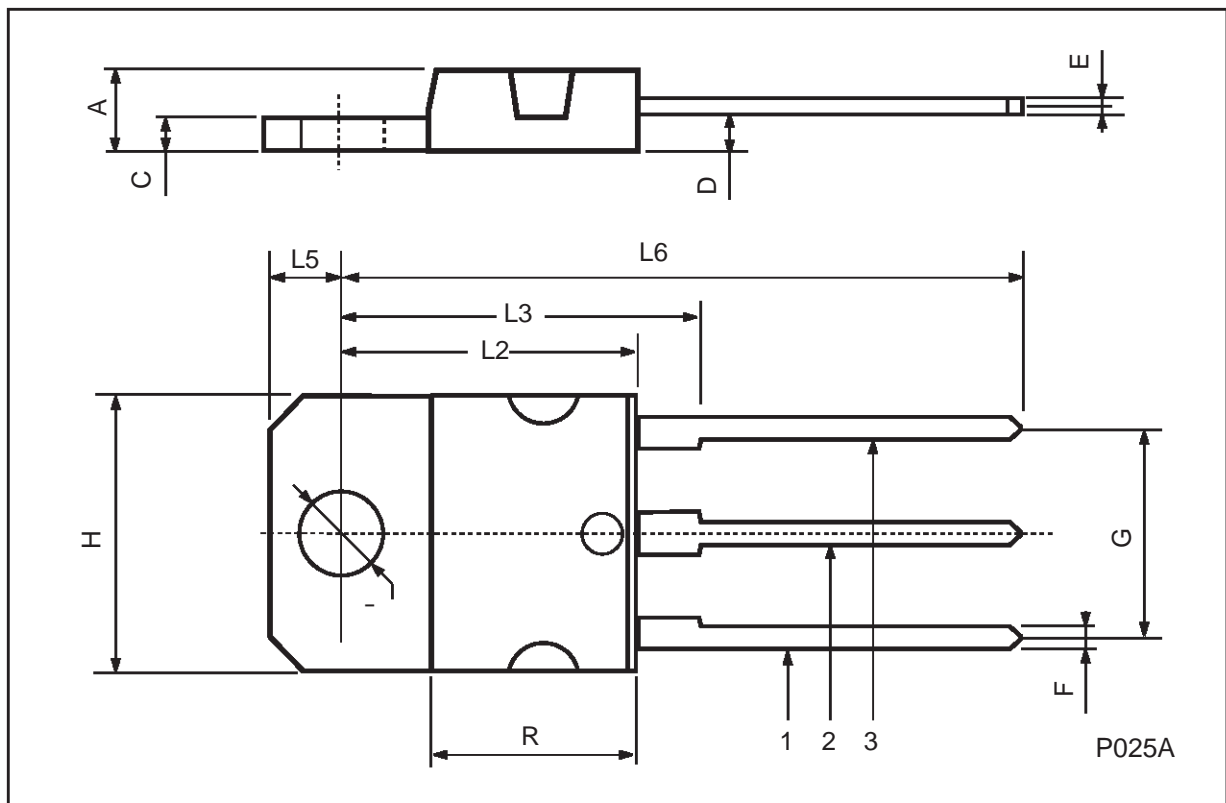

ISOWATT218 MECHANICAL DATA

DIM.	mm			inch		
	MIN.	TYP.	MAX.	MIN.	TYP.	MAX.
A	5.35		5.65	0.211		0.222
C	3.30		3.80	0.130		0.150
D	2.90		3.10	0.114		0.122
D1	1.88		2.08	0.074		0.082
E	0.75		0.95	0.030		0.037
F	1.05		1.25	0.041		0.049
F2	1.50		1.70	0.059		0.067
F3	1.90		2.10	0.075		0.083
G	10.80		11.20	0.425		0.441
H	15.80		16.20	0.622		0.638
L		9			0.354	
L1	20.80		21.20	0.819		0.835
L2	19.10		19.90	0.752		0.783
L3	22.80		23.60	0.898		0.929
L4	40.50		42.50	1.594		1.673
L5	4.85		5.25	0.191		0.207
L6	20.25		20.75	0.797		0.817
N	2.1		2.3	0.083		0.091
R		4.6			0.181	
DIA	3.5		3.7	0.138		0.146

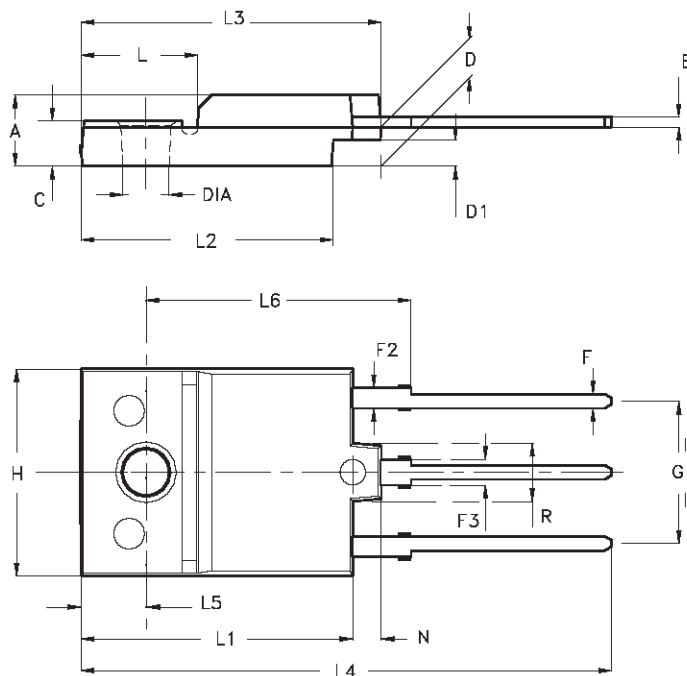

- Weight : 4.9 g (typ.)
- Maximum Torque (applied to mounting flange) Recommended 0.8 Nm; Maximum: 1 Nm
- The side of the dissipator must be flat within 80 μm

P025C/A

Information furnished is believed to be accurate and reliable. However, STMicroelectronics assumes no responsibility for the consequences of use of such information nor for any infringement of patents or other rights of third parties which may result from its use. No license is granted by implication or otherwise under any patent or patent rights of STMicroelectronics. Specification mentioned in this publication are subject to change without notice. This publication supersedes and replaces all information previously supplied. STMicroelectronics products are not authorized for use as critical components in life support devices or systems without express written approval of STMicroelectronics.

The ST logo is a trademark of STMicroelectronics

© 2002 STMicroelectronics – Printed in Italy – All Rights Reserved

STMicroelectronics GROUP OF COMPANIES

Australia - Brazil - Canada - China - Finland - France - Germany - Hong Kong - India - Israel - Italy - Japan - Malaysia - Malta - Morocco - Singapore - Spain - Sweden - Switzerland - United Kingdom - United States.

<http://www.st.com>