

# Piezoelectric Actuator Driver



## BU64562GWZ

### ●General Description

The BU64562GWZ is designed to drive Piezo motors for camera auto focus. It has an integrated D/A converter for setting the output voltage. This lens driver includes the slope sequence to reduce the driving noise of Piezo actuator. The functional lens system can be controlled through 2-wire serial interface (I<sup>2</sup>C BUS compatible).

### ●Key Specifications

- PMOS ON Resistance: 0.70 Ω (Typ.)
- NMOS ON Resistance: 0.70 Ω (Typ.)
- Standby current consumption: 0 μA (Typ.)
- High precision 15MHz Oscillator: ± 3 %
- Operating temperature range: - 25 to + 85 °C

### ●Features

- Ultra-small chip size package
- Low ON-Resistance Power CMOS output
- Built-in 15 MHz Oscillator (OSC)
- 2-wire serial interface (I<sup>2</sup>C BUS compatible)
- 1.8 V can be put into each control input terminal
- Slew rate control function of output voltage
- Standby current consumption 0 μA (Typ.)

### ●Applications

- Auto focus of cell phone
- Auto focus of Digital still camera
- Camera Modules
- Lens Auto focus
- Web, Tablet and PC Cameras

### ●Typical Application Circuit

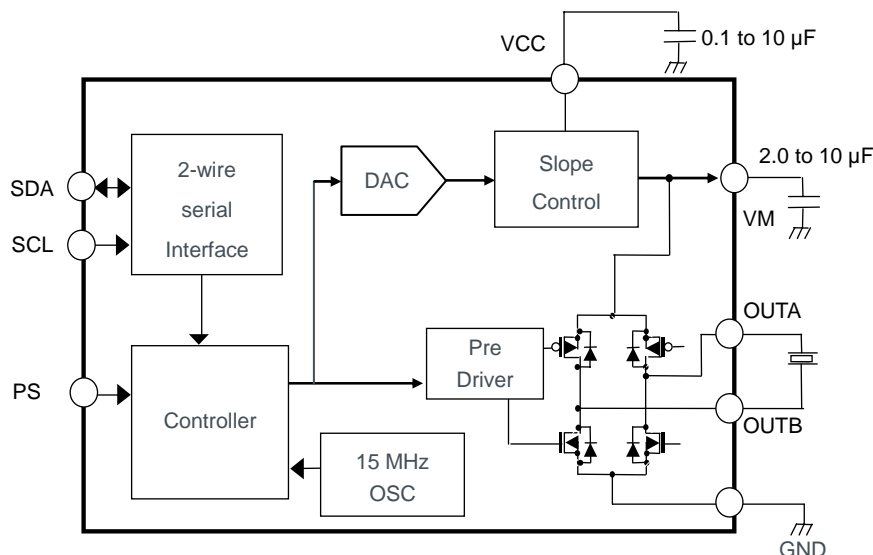

Figure 1. Typical Application Circuit

●Pin Configuration

	1	2	3	4
A	SCL	SDA	OUTA	GND
B	PS	VCC	VM	OUTB

Figure 2. Pin configuration (TOP VIEW)

●Pin Description

Ball No.	Ball Name	Function
A1	SCL	2-wire serial interface clock input
A2	SDA	2-wire serial interface data input
A3	OUTA	Actuator terminal
A4	GND	Ground
B1	PS	Power save input
B2	VCC	Power supply voltage
B3	VM	VM output voltage
B4	OUTB	Actuator terminal

●Block Diagram

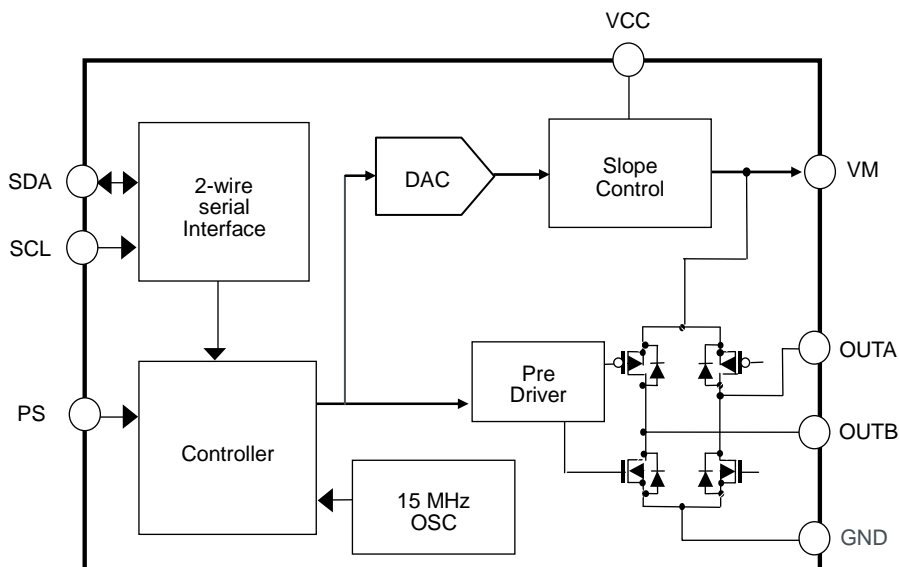

Figure 3. Block Diagram

### ● Absolute Maximum Ratings

Parameter	Symbol	Limit	Unit
Power supply voltage	VCC	- 0.3 to + 5.5	V
Power save input voltage	VPS	- 0.3 to VCC + 0.3	V
Control input voltage (SCL, SDA)	VIN	- 0.3 to VCC + 0.3	V
Power dissipation	Pd	440 <sup>*1</sup>	mW
Operating temperature range	Topr	- 25 to + 85	°C
Junction temperature	Tjmax	125	°C
Storage temperature range	Tstg	- 55 to + 125	°C
H-bridge output current	Iout	- 500 to + 500 <sup>*2</sup>	mA
	Iout <sub>(peak)</sub>	- 850 to + 850 <sup>*3</sup>	mA

\*1 Conditions: mounted on a glass epoxy board (50 mm × 58 mm × 1.75 mm; 8 layers). In case of Ta > 25 °C, reduced by 4.4 mW / °C.

\*2 Must not exceed Pd, ASO, or Tjmax of 125 °C.

\*3 Must not exceed pulse width = 5 ms and Duty = 50 %.

### ● Recommended Operating Ratings

Parameter	Symbol	Min.	Typ.	Max.	Unit
Power supply voltage	VCC	2.3	3.0	4.8	V
Power save input voltage	VPS	0	-	4.8	V
Control input voltage (SCL, SDA)	VIN	0	-	4.8	V
2-wire serial interface transmission rate	SCL	-	-	400	kHz
H-bridge output current	IOUT	-	-	± 400 <sup>*4</sup>	mA
	Iout <sub>(peak)</sub>	-	-	± 750 <sup>*5</sup>	mA

\*4 Must not exceed Pd, ASO.

\*5 Must not exceed pulse width = 5 ms and Duty = 50 %.

**●Electrical Characteristics ( Unless otherwise specified Ta = 25 °C, VCC = 3.0 V )**

Parameter	Symbol	Limit			Unit	Conditions
		Min.	Typ.	Max.		
Overall						
Circuit current during standby operation	ICCST	-	0	1	μA	PS = L
Circuit current	ICC	-	1.8	3.0	mA	PS = H, SCL = 400 kHz, 15 MHz OSC active
UVLO						
UVLO voltage	VUVLO	1.8	-	2.2	V	
Power save input						
High level input voltage	VPSH	1.5	-	VCC	V	
Low level input voltage	VPSL	0	-	0.5	V	
High level input current	IPSH	15	30	60	μA	VINH = 3.0 V, pull down resistor 100 kΩ
Low level input current	IPSL	-	0	1	μA	VINL = 0 V
Control input(SDA,SCL)						
High level input voltage	VINH	1.5	-	VCC	V	
Low level input voltage	VINL	0	-	0.5	V	
Low level output voltage1	VOL1	-	-	0.4	V	IIN = 3.0 mA (SDA)
Low level output voltage2	VOL2	-	-	0.2	V	IIN = 0.7 mA (SDA)
High level input current	IINH	- 10	-	10	μA	Input voltage = VCC
Low level input current	IINL	- 10	-	10	μA	Input voltage = GND
H Bridge Drive						
Output ON-Resistance	RONP	-	0.7	0.85	Ω	
	RONN	-	0.7	0.85	Ω	
Cycle length of Sequence drive	TMIN	10.35	10.67	11.00	μs	*6 Built in CLK 160 count, no load
Output rise time	Tr	-	0.1	0.8	μs	*7 No load
Output fall time	Tf	-	0.02	0.4	μs	*7 No load
VM voltage						
VM voltage (VM2=0x00)	VM00	- 10	0	100	mV	
VM voltage (VM2=0x8F)	VM8F	2.6	2.7	2.8	V	
VM voltage INL	VMINL	- 4	0	4		DAC_code = 0x20 to 0xFF, VCC = 4.8 V
VM voltage DNL	VMDNL	- 1	0	1		DAC_code = 0x20 to 0xFF, VCC = 4.8 V
VM ON-Resistance	VMR	-	0.7	0.85	Ω	

\*6 The time that 1 cycle of sequence drive at the below setting of 2-wire serial data  
 ta[7:0] = 0x13, brake1[7:0] = 0x03, tb[7:0] = 0x1E, brake2[7:0] = 0x6B, osc[2:0] = 0x0

\*7 Output switching wave

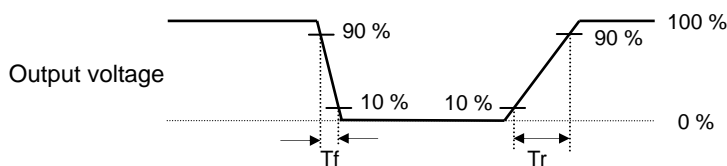

● Typical Performance Curves

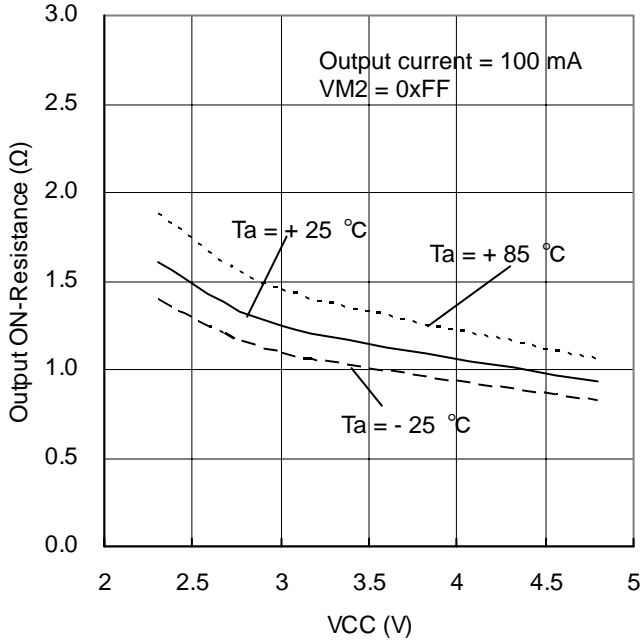

Figure 4. Output ON-Resistance (RONP + RONN)

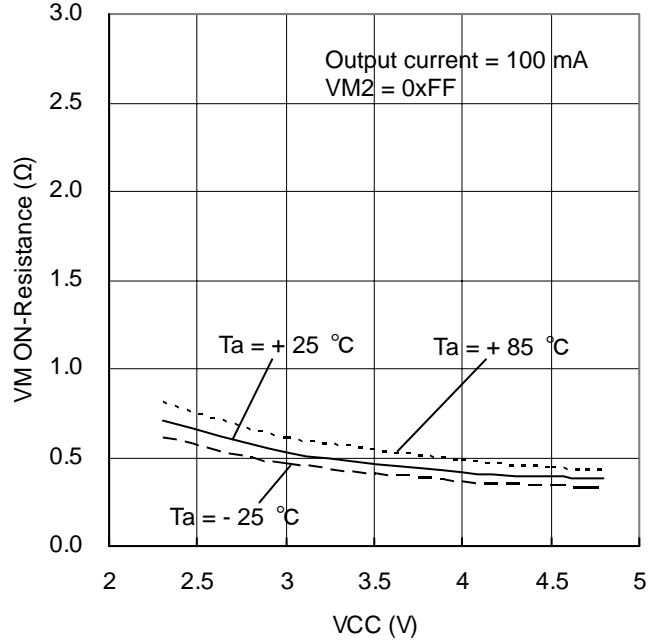

Figure 5. VM ON-Resistance

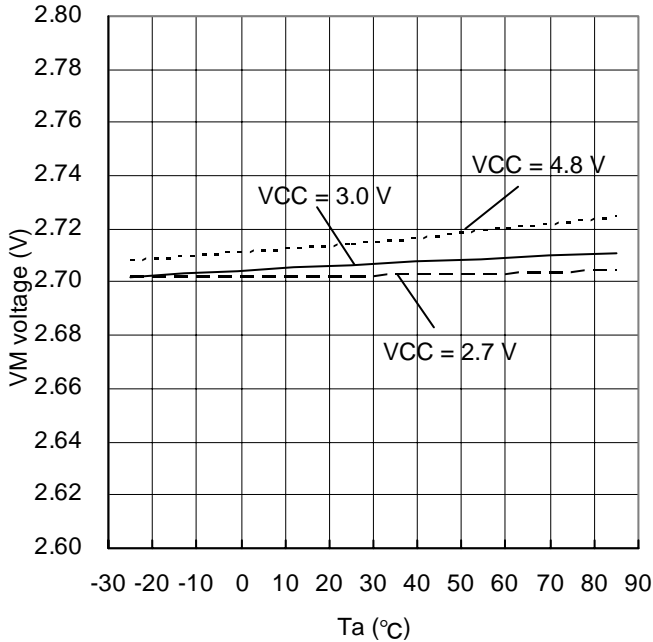

Figure 6. VM voltage (VM2 = 0x8F)

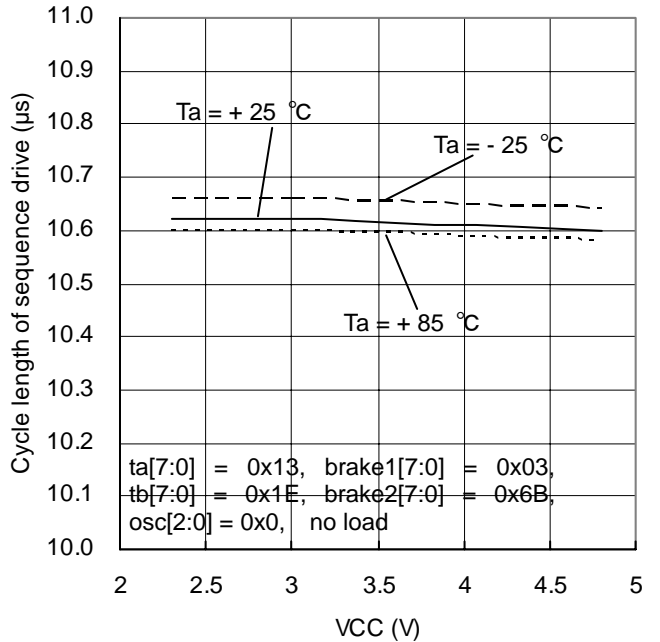
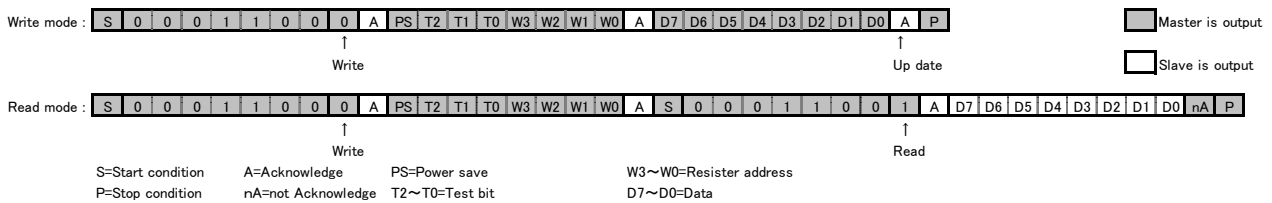

Figure 7. Cycle length of sequence drive

●2-wire Serial Interface Register detail



Register name	Setting item	Description
PS	Serial power save	0 = Driver in standby mode, 1 = Driver in operating mode
T[2:0]	Test register address	Test register = 000b
W[3:0]	Register address	Setting Register address
D[9:0]	Data bits	Setting Register data

●Register Map

Address	W3	W2	W1	W0	D7	D6	D5	D4	D3	D2	D1	D0
0x0	0	0	0	0	HiZE	0	0	0	0	START	MODE	dir
0x1	0	0	0	1	ta[7]	ta[6]	ta[5]	ta[4]	ta[3]	ta[2]	ta[1]	ta[0]
0x2	0	0	1	0	brake1[7]	brake1[6]	brake1[5]	brake1[4]	brake1[3]	brake1[2]	brake1[1]	brake1[0]
0x3	0	0	1	1	tb[7]	tb[6]	tb[5]	tb[4]	tb[3]	tb[2]	tb[1]	tb[0]
0x4	0	1	0	0	brake2[7]	brake2[6]	brake2[5]	brake2[4]	brake2[3]	brake2[2]	brake2[1]	brake2[0]
0x5	0	1	0	1	cnt[7]	cnt[6]	cnt[5]	cnt[4]	cnt[3]	cnt[2]	cnt[1]	cnt[0]
0x6	0	1	1	0	cnt[15]	cnt[14]	cnt[13]	cnt[12]	cnt[11]	cnt[10]	cnt[9]	cnt[8]
0x7	0	1	1	1	pa	pb	osc[2]	osc[1]	osc[0]	cntck[2]	cntck[1]	cntck[0]
0x8	1	0	0	0	V1[7]	V1[6]	V1[5]	V1[4]	V1[3]	V1[2]	V1[1]	V1[0]
0x9	1	0	0	1	V2[7]	V2[6]	V2[5]	V2[4]	V2[3]	V2[2]	V2[1]	V2[0]
0xA	1	0	1	0	step2[4]	step2[3]	step2[2]	step2[1]	step2[0]	step1[2]	step1[1]	step1[0]
0xB	1	0	1	1	TEST	TEST	TEST	TEST	TEST	TEST	EXT	TEST
0xC	1	1	0	0	TEST	TEST	TEST	TEST	TEST	TEST	TEST	TEST
0xD	1	1	0	1	TEST	TEST	TEST	TEST	TEST	TEST	TEST	TEST

## ●Register catalogue

Bit	Bit Name	Description	Reset
<b>Address : 0x0</b>			
D[7]	HiZE	Dead time setting (Reference 13 page) (Lo: 1 cycle of osc[2:0] setting, Hi: Internal CLK 1 cycle (Typ. 66.67 ns))	0x0
D[6:3]	TEST	Set '0x0'	0x0
D[2]	START	Start setting for sequence (Reference 14 page)	0x0
D[1]	MODE	Mode of brake1 / brake2 setting for sequence (Reference 13 page)	0x0
D[0]	dir	Output direction setting while sequence (Reference 14 page)	0x0
<b>Address : 0x1</b>			
D[7:0]	ta[7:0]	Drive waveform setting[7:0] (Reference 10 page)	0x00
<b>Address : 0x2</b>			
D[7:0]	brake1[7:0]	Drive waveform setting[7:0] (Reference 10 page)	0x00
<b>Address : 0x3</b>			
D[7:0]	tb[7:0]	Drive waveform setting[7:0] (Reference 10 page)	0x00
<b>Address : 0x4</b>			
D[7:0]	brake2[7:0]	Drive waveform setting[7:0] (Reference 10 page)	0x00
<b>Address : 0x5</b>			
D[7:0]	cnt[7:0]	Drive time count setting[7:0] (Reference 12 page)	0x00
<b>Address : 0x6</b>			
D[7:0]	cnt[15:8]	Drive time count setting[15:8] (Reference 12 page)	0x00
<b>Address : 0x7</b>			
D[7]	pa	Output logic setting a (Reference 13 page)	0x0
D[6]	pb	Output logic setting b (Reference 13 page)	0x0
D[5:3]	osc[2:0]	Internal CLK basic cycle setting [2:0] (Reference 11 page)	0x0
D[2:0]	cntck[2:0]	Drive time basic cycle setting[2:0] (It is possible to use Normal function only) (Reference 12 page)	0x0
<b>Address : 0x8</b>			
D[7:0]	V1[7:0]	For setting VM voltageBit [7:0] (Reference 16, 17 page)	0x00
<b>Address : 0x9</b>			
D[7:0]	V2[7:0]	For setting VM voltageBit [7:0] (Reference 16, 17 page)	0x00
<b>Address : 0xA</b>			
D[7:3]	step2[4:0]	For setting slope of VM voltageBit [4:0] (Reference 16, 17 page)	0x00
D[2:0]	step1[2:0]	For setting slope of VM voltageBit [2:0] (Reference 16, 17 page)	0x0
<b>Address : 0xB</b>			
D[7:2]	TEST	Set '0x0'	0x00
D[1]	EXT	Hi output while sequence, Low output at the stop mode (Reference 14 page)	0x0
D[0]	TEST	Set '0x0'	0x0
<b>Address : 0xC</b>			
D[7:0]	TEST	Set '0x00'	0x00

●2-wire Serial Interface Data timing

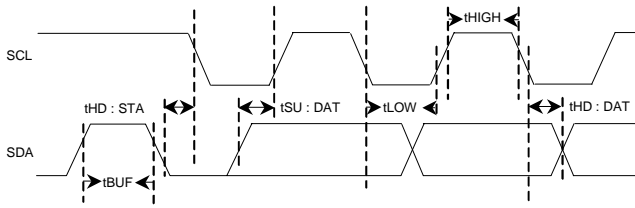

Figure 8. Serial data timing

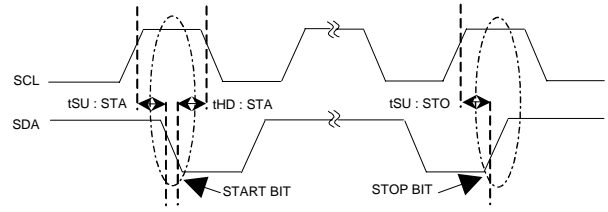

Figure 9. Start, Stop bit timing

Timing Characteristics (Unless otherwise specified, Ta = 25 °C, VCC = 2.3 to 4.8 V)

Parameter	Symbol	FAST-MODE <sup>*8</sup>			STANDARD-MODE <sup>*8</sup>			Unit
		Min.	Typ.	Max.	Min.	Typ.	Max.	
SCL clock frequency	fSCL	-	-	400	-	-	100	kHz
High period of the SCL clock	tHIGH	0.6	-	-	4.0	-	-	µs
Low period of the SCL clock	tLOW	1.3	-	-	4.7	-	-	µs
Hold time (repeated) START condition	tHD:STA	0.6	-	-	4.0	-	-	µs
Set-up time (repeated) START condition	tSU:STA	0.6	-	-	4.7	-	-	µs
Data hold time	tHD:DAT	0	-	0.9	0	-	3.45	µs
Data set-up time	tSU:DAT	100	-	-	250	-	-	ns
Set-up time for STOP condition	tSU:STO	0.6	-	-	4.0	-	-	µs
Bus free time between a STOP and START condition	tBUF	1.3	-	-	4.7	-	-	µs
Pulse width of spikes which must be suppressed by the input filter	tl	0	-	50	0	-	50	ns

\*8 Standard-mode and Fast-mode 2-wire serial interface devices must be able to transmit or receive at that speed. The maximum bit transfer rates of 100 kHz for Standard-mode devices and 400 kHz for Fast-mode devices. This transfer rates is provided the maximum transfer rates, for example it is able to drive 100 kHz of clocks with Fast-mode.

●Recommend to power supply turning on operation timing

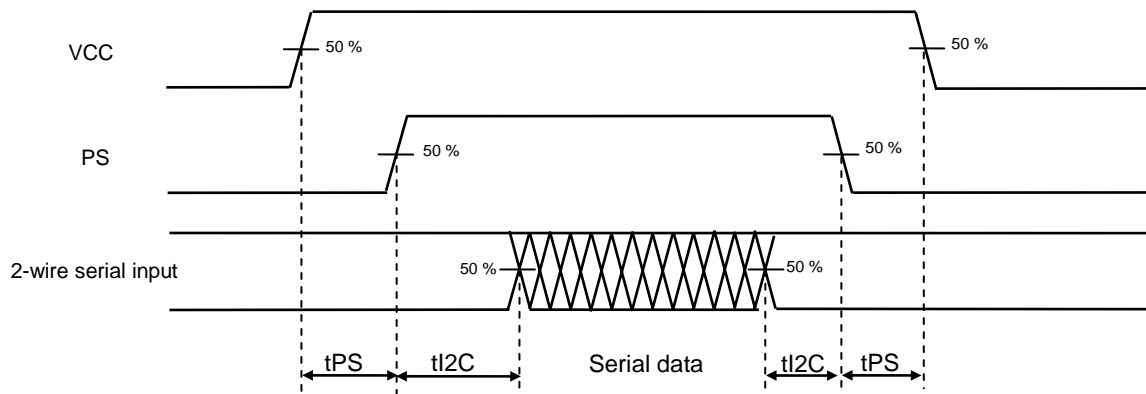

Figure 10. Sequence of data input timing to power supply

Parameter	Symbol	Recommendation limit			Unit
		Min.	Typ.	Max.	
PS input High voltage set-up time	tPS1	50	-	-	µs
2-wire serial interface input data set-up time	tI2C1	50	-	-	µs
PS input Low voltage set-up time	tPS2	0	-	-	µs
2-wire serial interface input data set-up time	tI2C2	0	-	-	µs



● Power Dissipation

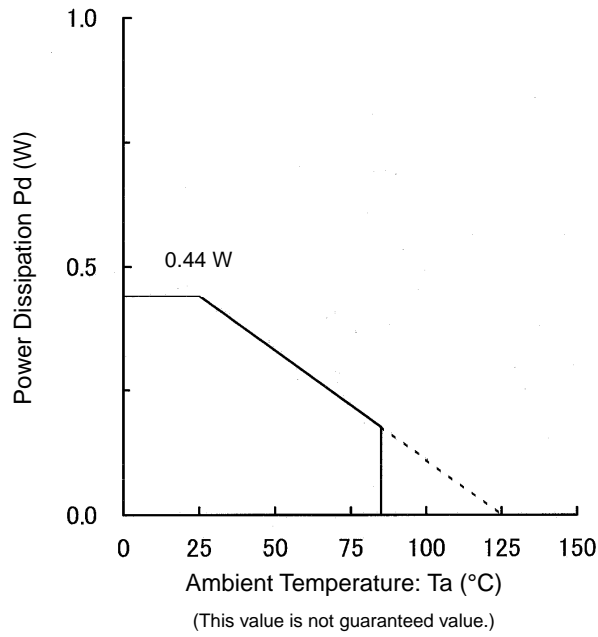
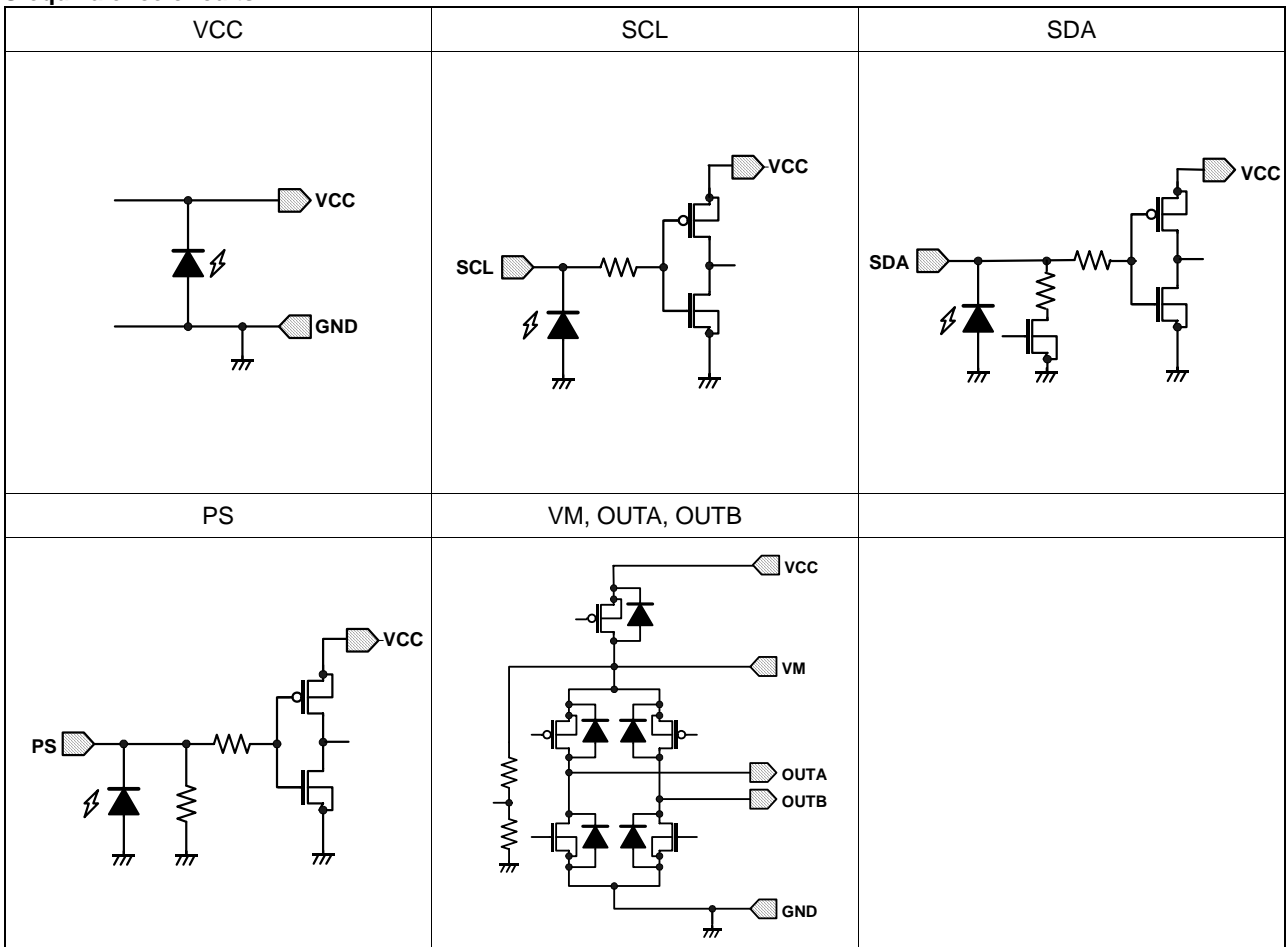

Figure 11. Power dissipation Pd (W)

● I/O equivalence circuits



●Description of Functions

1) The structure of the driving wave for Piezo actuator

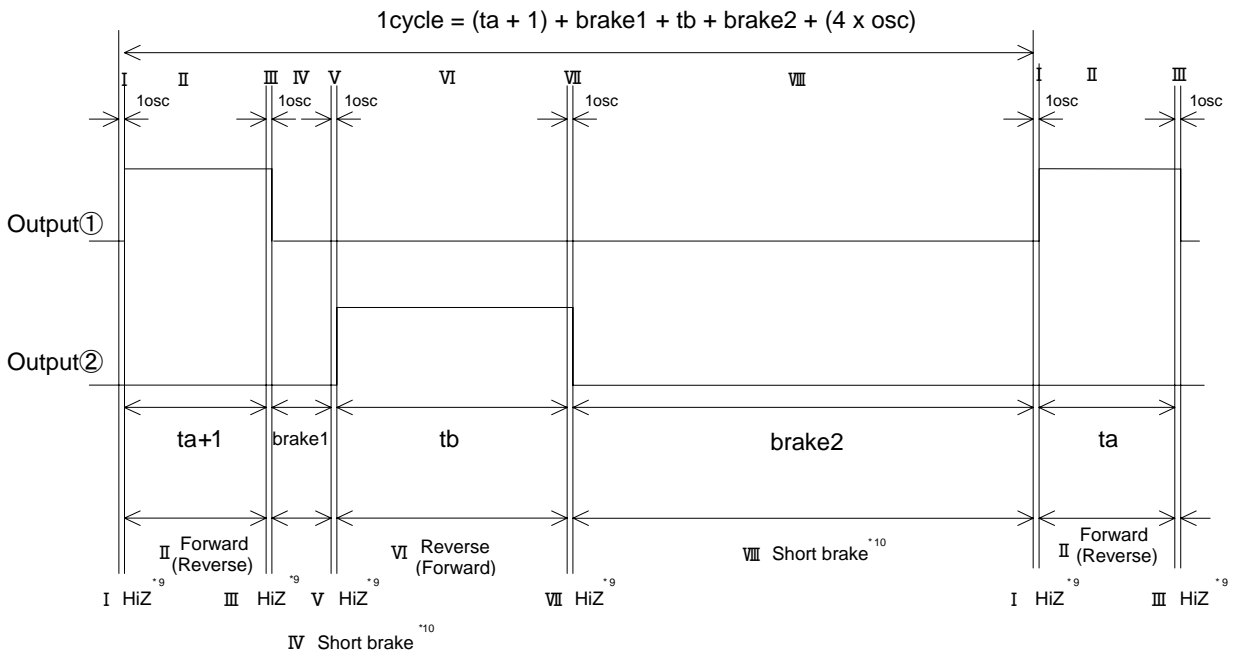

\*9 The state at osc = 0x0 or osc ≠ 0x0 and HiZE = 0x0 is HiZ.

\*10 At mode = 0, the output logic is a setting of a short brake.

dir (Address: 0x0, Data: D[0])	Output①	Output②	Note
0	OUTA	OUTB	Move to the direction of Macro
1	OUTB	OUTA	Move to the direction of infinity

Driving wave is set by the 4 parameters of ta / brake1 / tb / brake2.  
OSC period is set by the OSC (Internal clock basic cycle setting).

- ta : On section is ( ta + 1 - 1 ) = ta counts for Forward (Reverse) state.
- brake1 : On section is (brake1 - 1) count for short brake state.
- tb : On section is (tb1 - 1) count for Reverse (Forward) state.
- brake2 : On section is (brake2 - 1) count for short brake state.

(Ex.) In case of setting 1 cycle = 10.67 μs, ta = 1.27 μs, brake1 = 0.13 μs, tb = 1.93 μs, brake2 = 7.07 μs.  
osc[2:0]( = Basic cycle setting ) = 0x0 ( = Basic cycle = 66.67 ns ), and ta / brake1 / tb / brake2 setting below;

ta[7:0]	= 0x13	= 19 count	→ ON section = 19 + 1 - 1 = 19 count
brake1[7:0]	= 0x03	= 3 count	→ ON section = 2 count
tb[7:0]	= 0x1E	= 30 count	→ ON section = 29 count
brake2[7:0]	= 0x6B	= 107 count	→ ON section = 106 count

Table 1. Basic cycle setting [osc] Internal clock 1 cycle = 66.67 ns (Typ.)

osc[2:0]	Internal clock cycle number	osc[2:0]	Internal clock cycle number	osc[2:0]	Internal clock cycle number	osc[2:0]	Internal clock cycle number
0x0	1	0x2	3	0x4	5	0x6	7
0x1	2	0x3	4	0x5	6	0x7	8

Table 2. Driving waveform setting [ta]

ta[7:0]	OSC Cycle number	ta[7:0]	OSC Cycle number	ta[7:0]	OSC Cycle number	ta[7:0]	OSC Cycle number
0x00	1	0x40	64	0x80	128	0xC0	192
0x01	1	0x41	65	0x81	129	0xC1	193
0x02	2	0x42	66	0x82	130	0xC2	194
0x03	3	0x43	67	0x83	131	0xC3	195
...	...	...	...	...	...	...	...
0x3D	61	0x7D	125	0xBD	189	0xFD	253
0x3E	62	0x7E	126	0xBE	190	0xFE	254
0x3F	63	0x7F	127	0xBF	191	0xFF	255

Table 3. Driving waveform setting [brake1]

brake1[7:0]	OSC Cycle number	brake1[7:0]	OSC Cycle number	brake1[7:0]	OSC Cycle number	brake1[7:0]	OSC Cycle number
0x00	1	0x40	64	0x80	128	0xC0	192
0x01	1	0x41	65	0x81	129	0xC1	193
0x02	2	0x42	66	0x82	130	0xC2	194
0x03	3	0x43	67	0x83	131	0xC3	195
...	...	...	...	...	...	...	...
0x3D	61	0x7D	125	0xBD	189	0xFD	253
0x3E	62	0x7E	126	0xBE	190	0xFE	254
0x3F	63	0x7F	127	0xBF	191	0xFF	255

Table 4. Driving waveform setting [tb]

tb[7:0]	OSC Cycle number	tb[7:0]	OSC Cycle number	tb[7:0]	OSC Cycle number	tb[7:0]	OSC Cycle number
0x00	1	0x40	64	0x80	128	0xC0	192
0x01	1	0x41	65	0x81	129	0xC1	193
0x02	2	0x42	66	0x82	130	0xC2	194
0x03	3	0x43	67	0x83	131	0xC3	195
...	...	...	...	...	...	...	...
0x3D	61	0x7D	125	0xBD	189	0xFD	253
0x3E	62	0x7E	126	0xBE	190	0xFE	254
0x3F	63	0x7F	127	0xBF	191	0xFF	255

Table 5. Driving waveform setting [brake2]

brake2[7:0]	OSC Cycle number	brake2[7:0]	OSC Cycle number	brake2[7:0]	OSC Cycle number	brake2[7:0]	OSC Cycle number
0x00	1	0x40	64	0x80	128	0xC0	192
0x01	1	0x41	65	0x81	129	0xC1	193
0x02	2	0x42	66	0x82	130	0xC2	194
0x03	3	0x43	67	0x83	131	0xC3	195
...	...	...	...	...	...	...	...
0x3D	61	0x7D	125	0xBD	189	0xFD	253
0x3E	62	0x7E	126	0xBE	190	0xFE	254
0x3F	63	0x7F	127	0xBF	191	0xFF	255

Table 6. Driving waveform basic cycle setting [cntck] (Normal sequence only)

cntck[2:0]	Cycle number	cntck[2:0]	Cycle number	cntck[2:0]	Cycle number	cntck[2:0]	Cycle number
0x0	1	0x2	4	0x4	15	0x6	64
0x1	2	0x3	8	0x5	32	0x7	127

Table 7. Driving waveform count setting [cnt]

cnt[15:0]	count cycle number	cnt[15:0]	count cycle number	cnt[15:0]	count cycle number	cnt[15:0]	count cycle number
0x0000	-	0x4000	16384	0x8000	32768	0xC000	49152
0x0001	-	0x4001	16385	0x8001	32769	0xC001	49153
0x0002	2	0x4002	16386	0x8002	32770	0xC002	49154
0x0003	3	0x4003	16387	0x8003	32771	0xC003	49155
...	...	...	...	...	...	...	...
0x3FFD	16381	0x7FFD	32765	0xBFFD	49149	0xFFFFD	65533
0x3FFE	16382	0x7FFE	32766	0xBFFE	49150	0xFFFFE	65534
0x3FFF	16383	0x7FFF	32767	0xBFFF	49151	0xFFFFF	65535

Total Drive count number = (cntck[2:0]) x (cnt[15:0]) (cntck[2:0] is valid for Normal sequence.)

(Ex.) In case, setting cntck[2:0] = 0x1, cnt[15:0] = 0x8000

$$\text{cntck[2:0]} \times \text{cnt[15:0]} = 2 \times 32768$$

$$= 65536 \text{ count}$$

$$= 851.968 \text{ ms (In case of Driving waveform setting a cycle = 13 } \mu\text{s)}$$

2) Driver function table

Sequence setting

mode = 0, osc = 0x0 or osc ≠ 0x0 and HiZE = 0

	I	II	III	IV	V	VI	VII	VIII
Output①	HiZ	H	HiZ	L	L	L	L	L
Output②	L	L	L	L	HiZ	H	HiZ	L
State	HiZ	Forward	HiZ	Short brake	HiZ	Reverse	HiZ	Short brake

mode = 0, osc ≠ 0x0 and HiZE = 1

	I	II	III	IV	V	VI	VII	VIII
Output①	HiZ(66.67ns) →H	H	HiZ(66.67ns) →L	L	L	L	L	L
Output②	L	L	L	L	HiZ(66.67ns) →H	H	HiZ <sup>*11</sup>	L
State	HiZ(66.67ns) →Forward	Forward	HiZ(66.67ns) →Short brake	Short brake	HiZ(66.67ns) →Reverse	Reverse	HiZ <sup>*11</sup>	Short brake

\*11 The output ② status of VII doesn't become from HiZ (66.67 ns) to Low. It is outputted HiZ.

mode = 1, osc = 0x0 or osc ≠ 0x0 and HiZE = 0

	I	II	III	IV	V	VI	VII	VIII
Output①	HiZ	H	HiZ	HiZ	L	L	L	HiZ
Output②	L	L	L	HiZ	HiZ	H	HiZ	HiZ
State	HiZ	Forward	HiZ	HiZ	HiZ	Reverse	HiZ	HiZ

mode = 1, osc ≠ 0x0 and HiZE = 1

	I	II	III	IV	V	VI	VII	VIII
Output①	HiZ(66.67ns) →H	H	HiZ	HiZ	L	L	L <sup>*12</sup>	HiZ
Output②	L	L	L(66.67ns) →HiZ	HiZ	HiZ(66.67ns) →H	H	HiZ	HiZ
State	HiZ(66.67ns) →Forward	Forward	HiZ	HiZ	HiZ(66.67ns) →Reverse	Reverse	HiZ	HiZ

\*12 The output ① status of VII doesn't become from Low (66.67 ns) to HiZ. It is outputted Low.

Truth table of pa and pb

sequence	pa	pb	OUTA	OUTB	Function mode
OFF	0	0	HiZ	HiZ	STOP
OFF	0	1	L	H	Reverse
OFF	1	0	H	L	Forward
OFF	1	1	L	L	Short brake
ON	x	x	-	-	Follow with the sequence

3) Normal sequence

Setting ta[7:0], brake1[7:0], tb[7:0], brake2[7:0], osc[2:0], HiZE, pa, pb, cntck[2:0], cnt[15:0], V2[7:0]  
 (When START bit is High, it is impossible to update. When Start bit is Low, it is possible to update.)

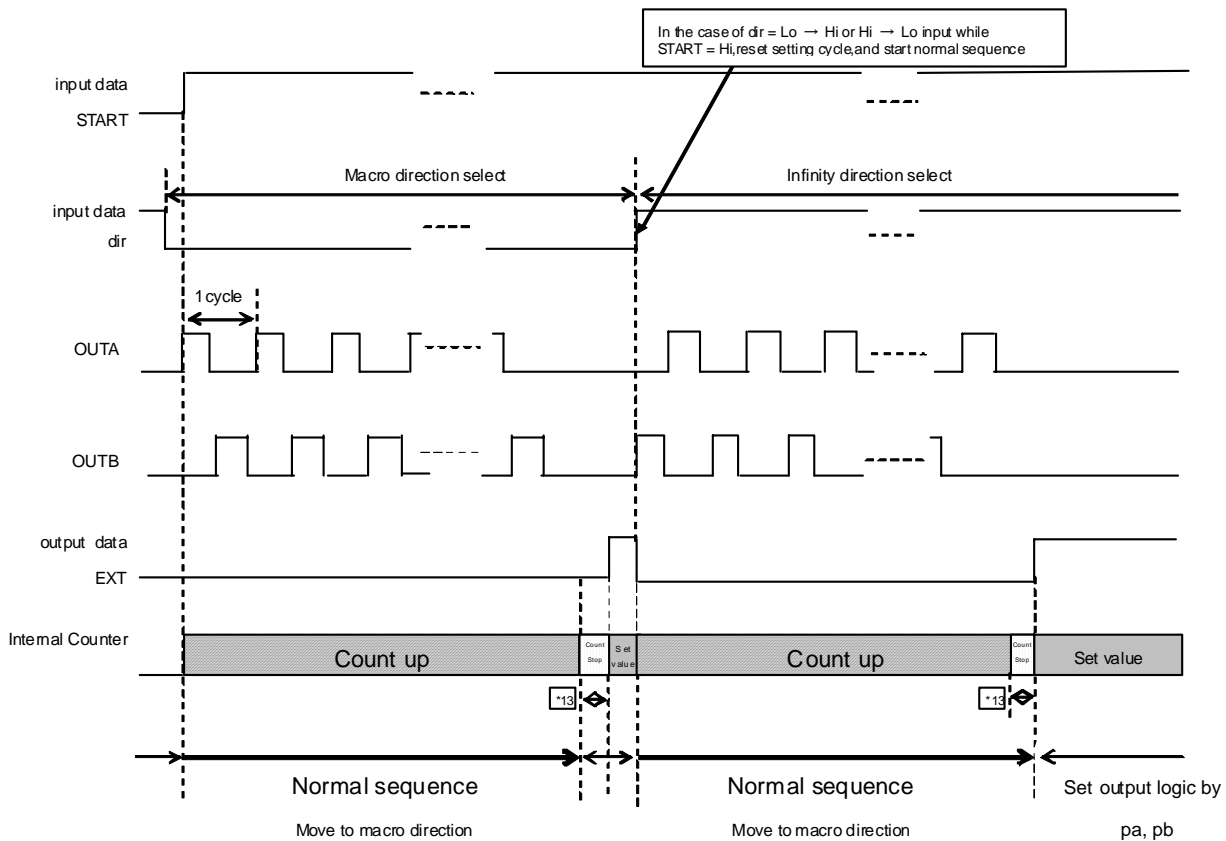
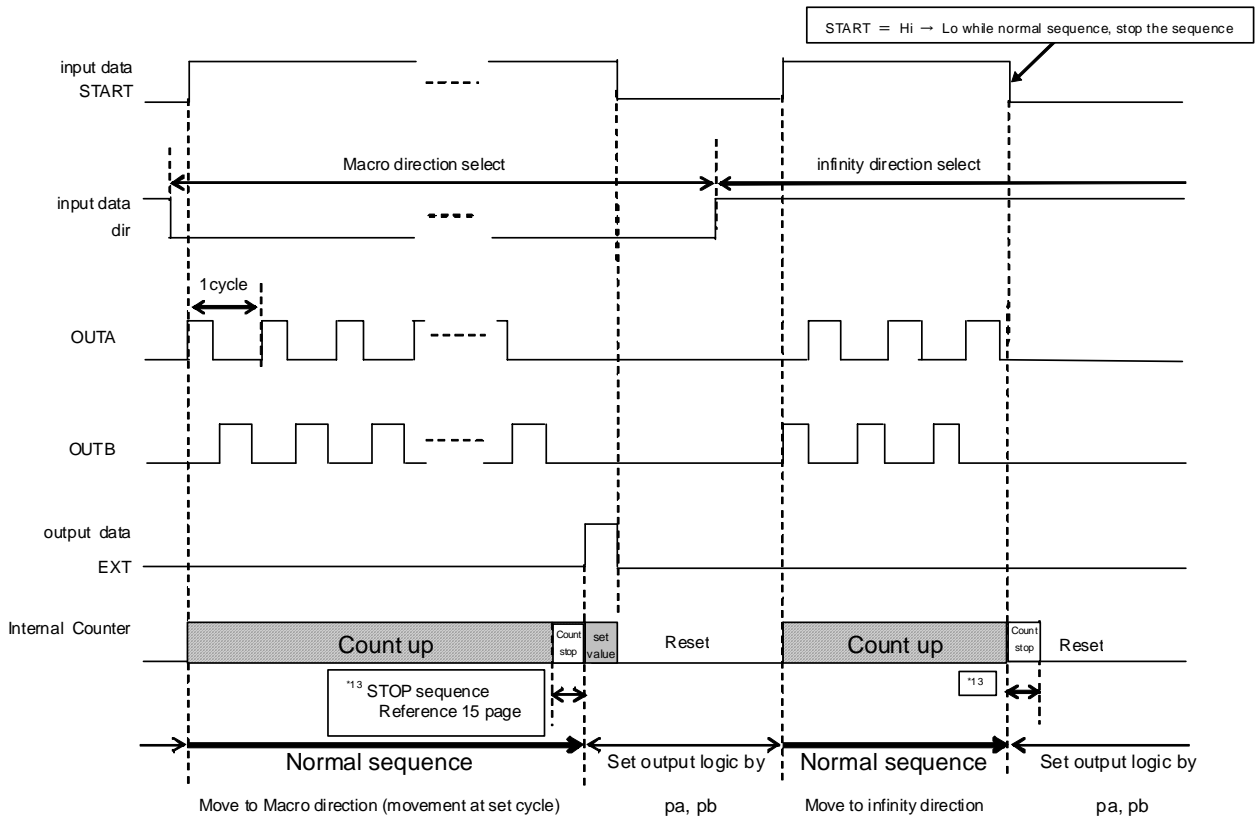

4) STOP sequence

It changes to the next state after short brake 16.7 μs (Typ.) when the state transition. Shown in the following while the sequence is operating is done.

- When normal sequence ends
- When normal sequence cancels

\* Special condition

There is a possibility that is not the pulse when {0x6, 0x5} address is small when Dir and START Bits are input at the same time after reset is released.

5) Output rise, fall waveform

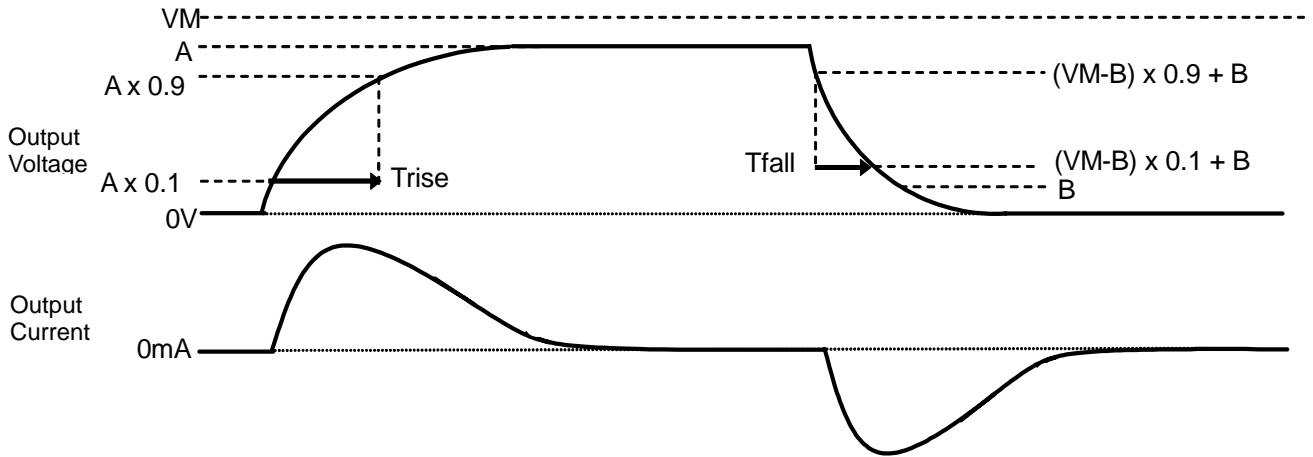

A voltage = (VM voltage) - (Simulation DC output current at the only Resistance load) x (Upper side output ON-Resistance)

B voltage = (Simulation DC output current at the only Resistance load) x (Lower side output ON-Resistance)

(Ex.) In case, the load is Resistance element = 2 Ω, capacity element = 0.033 μF  
 25 °C, VM = 3 V, Upper side output ON-Resistance = 1 Ω, Lower side output ON-Resistance = 1 Ω

$$\begin{aligned} \text{A voltage} &= (\text{VM voltage}) - ((\text{VM voltage}) / (\text{Load}(R) + \text{Total ON-Resistance})) \times (\text{Upper side ON-Resistance}) \\ &= 3 \text{ V} - (3 \text{ V} / (2 \Omega + (1 \Omega + 1 \Omega))) \times 1 \Omega \\ &= 2.25 \text{ V} \end{aligned}$$

$$\begin{aligned} \text{B voltage} &= ((\text{VM voltage}) / (\text{Load}(R) + \text{Total ON-Resistance})) \times (\text{Lower side ON-R}) \\ &= (3 \text{ V} / (2 \Omega + (1 \Omega + 1 \Omega))) \times 1 \Omega \\ &= 0.75 \text{ V} \end{aligned}$$

$$\begin{aligned} \text{Rise time} &= \text{Trise} (\text{A} \times 0.1 \text{ to } \text{A} \times 0.9) &&= 100 \text{ ns (Typ.)} \\ \text{Fall time} &= \text{Tfall} ((\text{VM} - \text{B}) \times 0.9 + \text{B} \text{ to } (\text{VM} - \text{B}) \times 0.1 + \text{B}) &&= 100 \text{ ns (Typ.)} \end{aligned}$$

6) Setting method of VM voltage slope

The slope can be applied to the VM voltage by setting V1[7:0], V2[7:0], step1[2:0] and step2[4:0]. V1 and V2 are bits for setting VM voltage. The step1 and step2 are bits for setting VM slope. VM voltage increase that it set it every 50 μs.

It is necessary to enlarge the setting of V2 more than V1.  
LSB of each setting bits does not depend on the VCC voltage (LSB = 4.8 / 255 = 18.8 mV (Typ.)).

•Normal function

Setting V2[7:0] (V1[7:0] = 0x00, step1[2:0] = 0x0, step2[4:0] = 0x00)

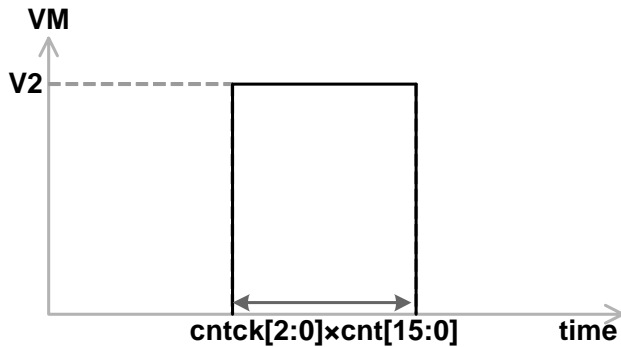

•One time slope

Setting V2[7:0] and step2[4:0] (V1[7:0] = 0x00, step1[2:0] = 0x0 and cntck[2:0] = 0x0)

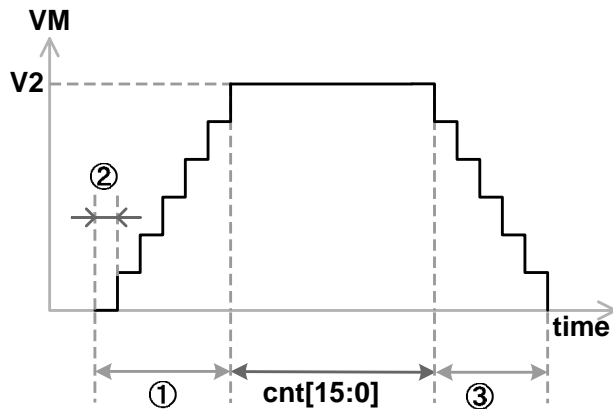

- ① = 50 μs × V2[7:0] / step2[4:0]
- ② = 50 μs (The first step output the keeping voltage.)
- ③ = 50 μs × ( V2[7:0] / step2[4:0] - 1 )



•Two times slope

1. Setting V1[7:0], V2[7:0], step1[2:0] and step2[4:0] (cntck[2:0] = 0x0)

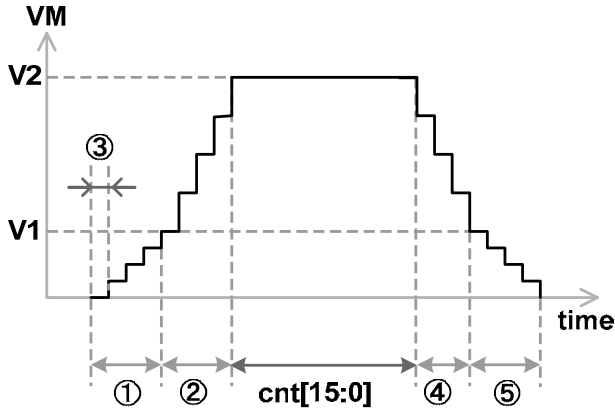

- ① =  $50 \mu\text{s} \times V1[7:0] / \text{step1}[2:0]$
- ② =  $50 \mu\text{s} \times (V2[7:0] - V1[7:0]) / \text{step2}[4:0]$
- ③ =  $50 \mu\text{s}$  (The first step output the keeping voltage.)
- ④ =  $50 \mu\text{s} \times ((V2[7:0] - V1[7:0]) / \text{step2}[4:0] - 1)$
- ⑤ =  $50 \mu\text{s} \times V1[7:0] / \text{step1}[2:0]$

2. Setting V1[7:0], V2[7:0] and step2[4:0] (step1[2:0] = 0x0 and cntck[2:0] = 0x0)

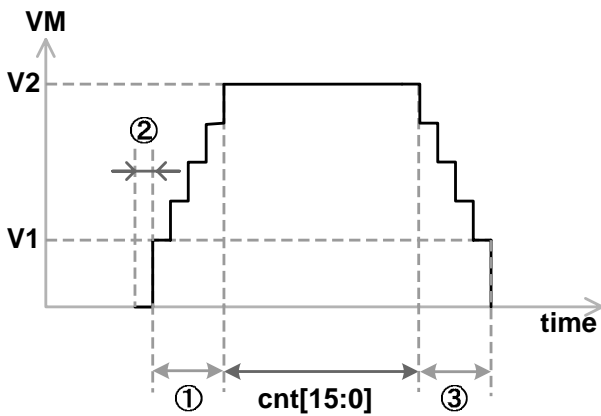

- ① =  $50 \mu\text{s} \times (V2[7:0] - V1[7:0]) / \text{step2}[4:0]$
- ② =  $50 \mu\text{s}$  (The first step output the keeping voltage.)
- ③ =  $50 \mu\text{s} \times (V2[7:0] - V1[7:0]) / \text{step2}[4:0]$

3. Setting V1[7:0], V2[7:0] and step1[2:0] (step2[4:0] = 0x00 and cntck[2:0] = 0x0)

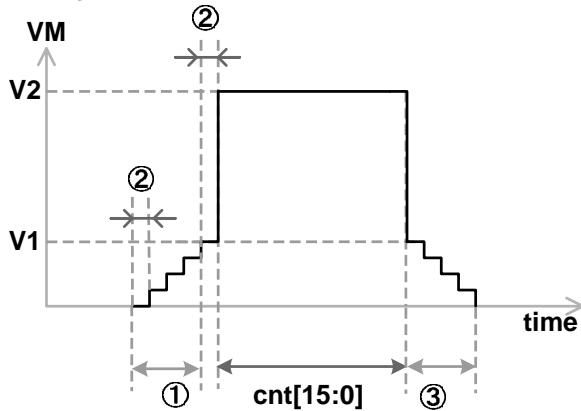

- ① =  $50 \mu\text{s} \times V1[7:0] / \text{step1}[2:0]$
- ② =  $50 \mu\text{s}$  (The first step output the keeping voltage.)
- ③ =  $50 \mu\text{s} \times V1[7:0] / \text{step1}[2:0]$

## ●Operational Notes

- 1) Absolute maximum ratings  
Use of the IC in excess of absolute maximum ratings, such as the applied voltage (VCC) or operating temperature range (Topr), may result in IC damage. Assumptions should not be made regarding the state of the IC (short mode or open mode) when such damage is suffered. A physical safety measure, such as a fuse, should be implemented when using the IC at times where the absolute maximum ratings may be exceeded.
- 2) Storage temperature range (Tstq)  
As long as the IC is kept within this range, there should be no problems in the IC's performance. Conversely, extreme temperature changes may result in poor IC performance, even if the changes are within the above range.
- 3) Power supply and wiring  
Be sure to connect the power terminals outside the IC. Do not leave them open. Because a return current is generated by a counter electromotive force of the motor, take necessary measures such as putting a Capacitor between the power source and the ground as a passageway for the regenerative current. Be sure to connect a Capacitor of proper capacitance (0.1 to 10  $\mu$ F) between the power source and the ground at the foot of the IC, and ensure that there is no problem in properties of electrolytic Capacitors such as decrease in capacitance at low temperatures. When the connected power source does not have enough current absorbing capability, there is a possibility that the voltage of the power source line increases by the regenerative current exceeds the absolute maximum rating of this product and the peripheral circuits.  
Therefore, be sure to take physical safety measures such as putting a zener diode for a voltage clamp between the power source the ground.
- 4) Ground terminal and wiring  
The potential at GND terminal should be made the lowest under any operating conditions. Ensure that there are no terminals where the potentials are below the potential at GND terminal, including the transient phenomena.  
Also prevent the voltage variation of the ground wiring patterns of external components. Use short and thick power source and ground wirings to ensure low impedance.
- 5) Thermal design  
Use a proper thermal design that allows for a sufficient margin of the power dissipation at actual operating conditions.
- 6) Pin short and wrong direction assembly of the device  
Use caution when positioning the IC for mounting on printed circuit boards. The IC may be damaged if there is any connection error or if positive and ground power supply terminals are reversed. The IC may also be damaged if pins are shorted together or are shorted to other circuit's power lines.
- 7) Avoiding strong magnetic field  
Malfunction may occur if the IC is used around a strong magnetic field.
- 8) ASO  
Ensure that the output transistors of the motor driver are not driven under excess conditions of the absolute maximum ratings and ASO.
- 9) TSD circuit  
This IC incorporates a TSD circuit. If the temperature of the chip reaches the below temperature, the motor coil output will be opened. The TSD circuit is designed only to shut off the IC to prevent runaway thermal operation. It is not designed to protect the IC or to guarantee its operation. Do not continue to use the IC after use of the TSD feature or use the IC in an environment where the its assumed that the TSD feature will be used.

TSD ON temperature [°C] (Typ.)	Hysteresis temperature [°C] (Typ.)
150	20

- 10) PS terminal  
Release PS after rising VCC. PS works resetting logic as well. If keep connecting PS with VCC, resetting cannot be done cause malfunction or destroy.

### Status of this document

The Japanese version of this document is formal specification. A customer may use this translation version only for a reference to help reading the formal version.

If there are any differences in translation version of this document formal version takes priority.

●Ordering Information

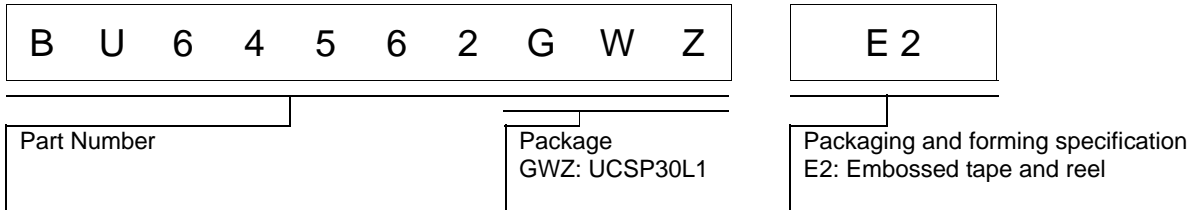

●Physical Dimension Tape and Reel Information

UCSP30L1 (BU64562GWZ)

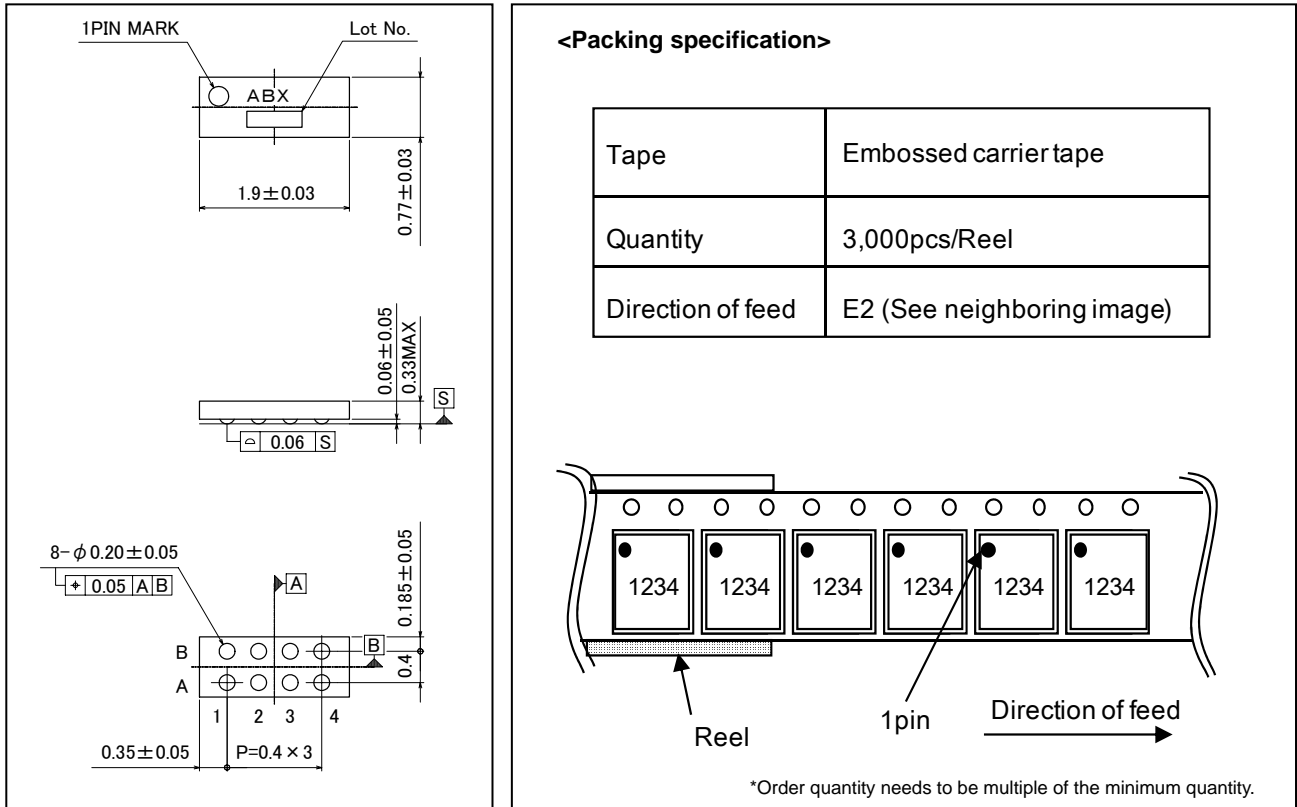

●Marking Diagram(TOP VIEW)

UCSP30L1 (BU64562GWZ)

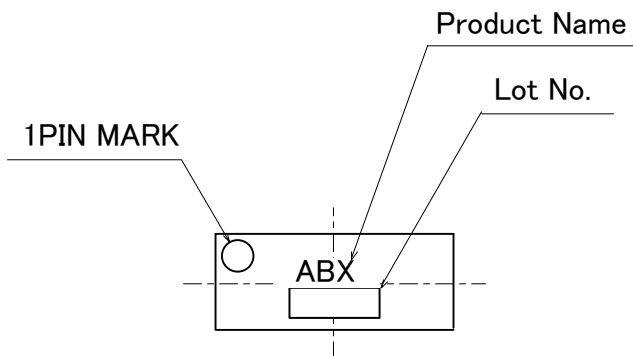

## ●Revision History

Date	Revision	Changes
9.Oct.2012	001	New Release

# Notice

## Precaution on using ROHM Products

- Our Products are designed and manufactured for application in ordinary electronic equipments (such as AV equipment, OA equipment, telecommunication equipment, home electronic appliances, amusement equipment, etc.). If you intend to use our Products in devices requiring extremely high reliability (such as medical equipment <sup>(Note 1)</sup>, transport equipment, traffic equipment, aircraft/spacecraft, nuclear power controllers, fuel controllers, car equipment including car accessories, safety devices, etc.) and whose malfunction or failure may cause loss of human life, bodily injury or serious damage to property ("Specific Applications"), please consult with the ROHM sales representative in advance. Unless otherwise agreed in writing by ROHM in advance, ROHM shall not be in any way responsible or liable for any damages, expenses or losses incurred by you or third parties arising from the use of any ROHM's Products for Specific Applications.

(Note1) Medical Equipment Classification of the Specific Applications

JAPAN	USA	EU	CHINA
CLASS III	CLASS III	CLASS II b	CLASS III
CLASS IV		CLASS III	

- ROHM designs and manufactures its Products subject to strict quality control system. However, semiconductor products can fail or malfunction at a certain rate. Please be sure to implement, at your own responsibilities, adequate safety measures including but not limited to fail-safe design against the physical injury, damage to any property, which a failure or malfunction of our Products may cause. The following are examples of safety measures:
  - Installation of protection circuits or other protective devices to improve system safety
  - Installation of redundant circuits to reduce the impact of single or multiple circuit failure
- Our Products are designed and manufactured for use under standard conditions and not under any special or extraordinary environments or conditions, as exemplified below. Accordingly, ROHM shall not be in any way responsible or liable for any damages, expenses or losses arising from the use of any ROHM's Products under any special or extraordinary environments or conditions. If you intend to use our Products under any special or extraordinary environments or conditions (as exemplified below), your independent verification and confirmation of product performance, reliability, etc. prior to use, must be necessary:
  - Use of our Products in any types of liquid, including water, oils, chemicals, and organic solvents
  - Use of our Products outdoors or in places where the Products are exposed to direct sunlight or dust
  - Use of our Products in places where the Products are exposed to sea wind or corrosive gases, including Cl<sub>2</sub>, H<sub>2</sub>S, NH<sub>3</sub>, SO<sub>2</sub>, and NO<sub>2</sub>
  - Use of our Products in places where the Products are exposed to static electricity or electromagnetic waves
  - Use of our Products in proximity to heat-producing components, plastic cords, or other flammable items
  - Sealing or coating our Products with resin or other coating materials
  - Use of our Products without cleaning residue of flux (even if you use no-clean type fluxes, cleaning residue of flux is recommended); or Washing our Products by using water or water-soluble cleaning agents for cleaning residue after soldering
  - Use of the Products in places subject to dew condensation
- The Products are not subject to radiation-proof design.
- Please verify and confirm characteristics of the final or mounted products in using the Products.
- In particular, if a transient load (a large amount of load applied in a short period of time, such as pulse. is applied, confirmation of performance characteristics after on-board mounting is strongly recommended. Avoid applying power exceeding normal rated power; exceeding the power rating under steady-state loading condition may negatively affect product performance and reliability.
- De-rate Power Dissipation (Pd) depending on Ambient temperature (Ta). When used in sealed area, confirm the actual ambient temperature.
- Confirm that operation temperature is within the specified range described in the product specification.
- ROHM shall not be in any way responsible or liable for failure induced under deviant condition from what is defined in this document.

## Precaution for Mounting / Circuit board design

- When a highly active halogenous (chlorine, bromine, etc.) flux is used, the residue of flux may negatively affect product performance and reliability.
- In principle, the reflow soldering method must be used; if flow soldering method is preferred, please consult with the ROHM representative in advance.

For details, please refer to ROHM Mounting specification

**Precautions Regarding Application Examples and External Circuits**

1. If change is made to the constant of an external circuit, please allow a sufficient margin considering variations of the characteristics of the Products and external components, including transient characteristics, as well as static characteristics.
2. You agree that application notes, reference designs, and associated data and information contained in this document are presented only as guidance for Products use. Therefore, in case you use such information, you are solely responsible for it and you must exercise your own independent verification and judgment in the use of such information contained in this document. ROHM shall not be in any way responsible or liable for any damages, expenses or losses incurred by you or third parties arising from the use of such information.

**Precaution for Electrostatic**

This Product is electrostatic sensitive product, which may be damaged due to electrostatic discharge. Please take proper caution in your manufacturing process and storage so that voltage exceeding the Products maximum rating will not be applied to Products. Please take special care under dry condition (e.g. Grounding of human body / equipment / solder iron, isolation from charged objects, setting of Ionizer, friction prevention and temperature / humidity control).

**Precaution for Storage / Transportation**

1. Product performance and soldered connections may deteriorate if the Products are stored in the places where:
  - [a] the Products are exposed to sea winds or corrosive gases, including Cl<sub>2</sub>, H<sub>2</sub>S, NH<sub>3</sub>, SO<sub>2</sub>, and NO<sub>2</sub>
  - [b] the temperature or humidity exceeds those recommended by ROHM
  - [c] the Products are exposed to direct sunshine or condensation
  - [d] the Products are exposed to high Electrostatic
2. Even under ROHM recommended storage condition, solderability of products out of recommended storage time period may be degraded. It is strongly recommended to confirm solderability before using Products of which storage time is exceeding the recommended storage time period.
3. Store / transport cartons in the correct direction, which is indicated on a carton with a symbol. Otherwise bent leads may occur due to excessive stress applied when dropping of a carton.
4. Use Products within the specified time after opening a humidity barrier bag. Baking is required before using Products of which storage time is exceeding the recommended storage time period.

**Precaution for Product Label**

QR code printed on ROHM Products label is for ROHM's internal use only.

**Precaution for Disposition**

When disposing Products please dispose them properly using an authorized industry waste company.

**Precaution for Foreign Exchange and Foreign Trade act**

Since our Products might fall under controlled goods prescribed by the applicable foreign exchange and foreign trade act, please consult with ROHM representative in case of export.

**Precaution Regarding Intellectual Property Rights**

1. All information and data including but not limited to application example contained in this document is for reference only. ROHM does not warrant that foregoing information or data will not infringe any intellectual property rights or any other rights of any third party regarding such information or data. ROHM shall not be in any way responsible or liable for infringement of any intellectual property rights or other damages arising from use of such information or data.:
2. No license, expressly or implied, is granted hereby under any intellectual property rights or other rights of ROHM or any third parties with respect to the information contained in this document.

**Other Precaution**

1. This document may not be reprinted or reproduced, in whole or in part, without prior written consent of ROHM.
2. The Products may not be disassembled, converted, modified, reproduced or otherwise changed without prior written consent of ROHM.
3. In no event shall you use in any way whatsoever the Products and the related technical information contained in the Products or this document for any military purposes, including but not limited to, the development of mass-destruction weapons.
4. The proper names of companies or products described in this document are trademarks or registered trademarks of ROHM, its affiliated companies or third parties.

**General Precaution**

1. Before you use our Products, you are requested to carefully read this document and fully understand its contents. ROHM shall not be in any way responsible or liable for failure, malfunction or accident arising from the use of any ROHM's Products against warning, caution or note contained in this document.
2. All information contained in this document is current as of the issuing date and subject to change without any prior notice. Before purchasing or using ROHM's Products, please confirm the latest information with a ROHM sales representative.
3. The information contained in this document is provided on an "as is" basis and ROHM does not warrant that all information contained in this document is accurate and/or error-free. ROHM shall not be in any way responsible or liable for any damages, expenses or losses incurred by you or third parties resulting from inaccuracy or errors of or concerning such information.



BU64562GWZ - Web Page

Part Number	BU64562GWZ
Package	UCSP30L1
Unit Quantity	3000
Minimum Package Quantity	3000
Packing Type	Taping
Constitution Materials List	inquiry
RoHS	Yes