

Low Duty LCD Segment Driver for Automotive Application

BU91799KV-M MAX 200 segments (SEG50×COM4)

General Description

BU91799KV-M is a 1/4 duty general-purpose LCD driver that can be used for automotive applications and can drive up to 200 LCD Segments. It can support operating temperature of up to +105°C and is qualified AEC-Q100 Grade2, as required for automotive applications. It has integrated display RAM for reducing CPU load. Also, it is designed with low power consumption and no external component needed..

Features

- AEC-Q100 Qualified (Note)
- Integrated RAM for Display Data (DDRAM): 50 x 4 bit (Max 200 Segment)
- LCD Drive Output : 4 Common Output, Max 50 Segment output
- Integrated Buffer AMP for LCD Driving
- Integrated Oscillator Circuit
- No External Components
- Low Power Consumption Design
- Independent Power Supply for LCD Driving
- Integrated Electrical Volume Register (EVR) function (Note) Grade 2

Applications

- Instrument Clusters
- Climate Controls
- Car Audios / Radios
- Metering
- White Goods
- Healthcare Products
- Battery Operated Applications etc.

Key Specifications

- Supply Voltage Range: +2.5V to +6.0V
- LCD Drive Power Supply Range: +2.5V to +6.0V
- Operating Temperature Range: -40°C to +105°C
- Max Segments: 200 Segments
- Display Duty: 1/4
- Bias: 1/2, 1/3 selectable
- Interface: 2wire Serial Interface

Special Characteristics

- ESD(HBM): ±2000V
- Latch-up current: ±100mA

Package

W (Typ.) x D (Typ.) x H (Max.)

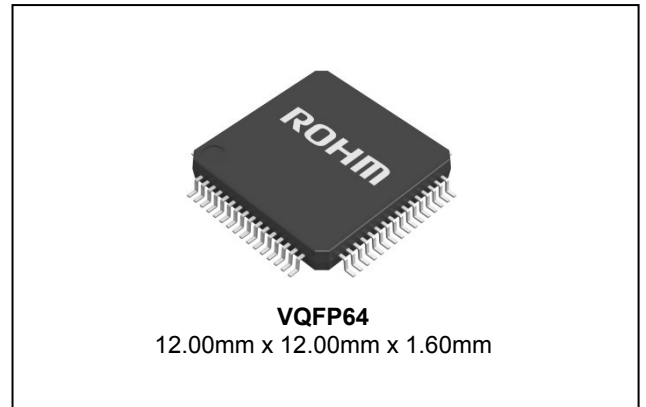

Typical Application Circuit

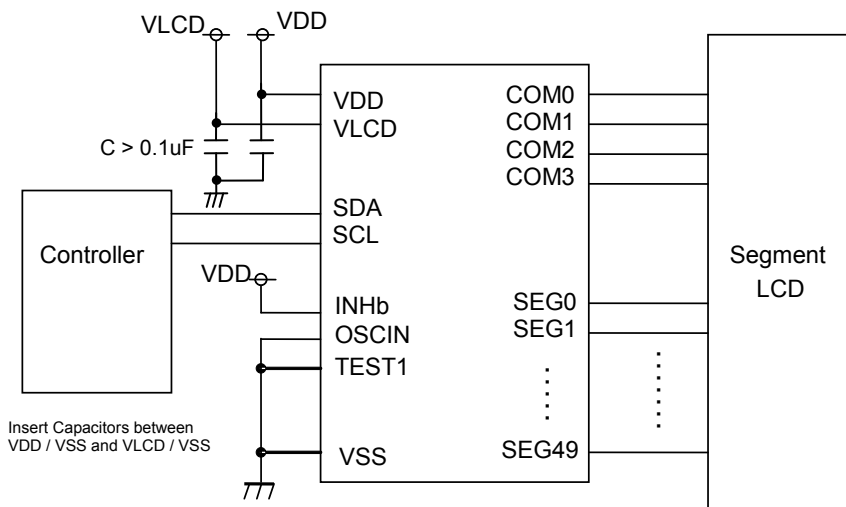

Internal Clock Mode

Figure 1. Typical Application Circuit

○Product structure : Silicon monolithic integrated circuit ○This product is not designed for protection against radioactive rays.

Block Diagram / Pin Configuration / Pin Description

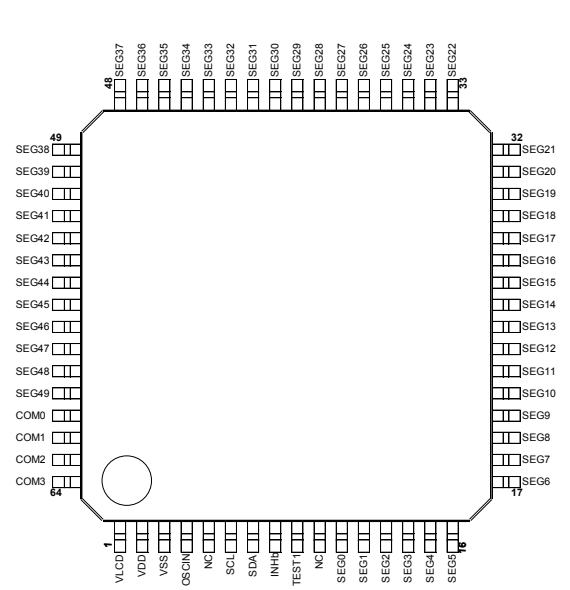
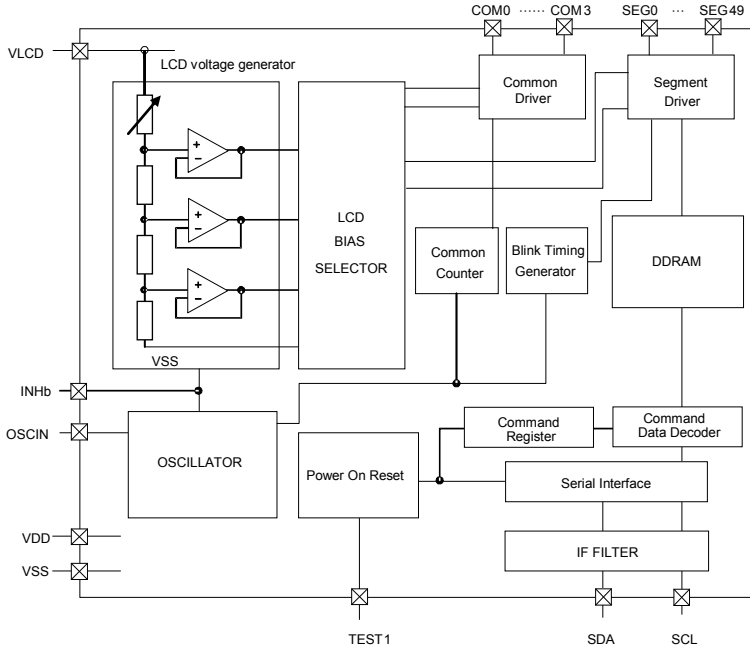

Figure 2. Block Diagram

Figure 3. Pin Configuration (TOP VIEW)

Table 1 Pin Description

Pin Name	Pin No.	I/O	Function	Handling when unused
INHb	8	I	Input terminal for display control VDD: Display enable VSS: Display disable	VDD
TEST1	9	I	POR enable setting VDD: POR disable (Note) VSS: POR enable	VSS
NC	10	-	Non connection	OPEN
NC	5	-	Non connection	OPEN
OSCIN	4	I	External clock input External clock and Internal clock modes can be selected by command Must be connected to VSS when using internal oscillator.	VSS
SDA	7	I/O	Serial data in-out terminal	-
SCL	6	I	Serial clock terminal	-
VSS	3		GND	-
VDD	2		Power supply	-
VLCD	1		Power supply for LCD driving	-
SEG0-49	11-60	O	SEGMENT output for LCD driving	OPEN
COM0-3	61-64	O	COMMON output for LCD driving	OPEN

(Note) This function is guaranteed by design, not tested in production process. Software Reset is necessary to initialize IC in case of TEST1=VDD.

Absolute Maximum Ratings (VSS=0V)

Parameter	Symbol	Ratings	Unit	Remarks
Maximum Voltage1	VDD	-0.5 to +7.0	V	Power Supply
Maximum Voltage2	VLCD	-0.5 to +7.0	V	LCD Drive Voltage
Power Dissipation	Pd	1.0 ^(Note1)	W	
Input Voltage Range	VIN	-0.5 to VDD+0.5	V	
Operational Temperature Range	Topr	-40 to +105	°C	
Storage Temperature Range	Tstg	-55 to +125	°C	

(Note1) Derate by 10mW/°C when operating above Ta=25°C (when mounted in ROHM's standard board).

Caution: Operating the IC over the absolute maximum ratings may damage the IC. The damage can either be a short circuit between pins or an open circuit between pins and the internal circuitry. Therefore, it is important to consider circuit protection measures, such as adding a fuse, in case the IC is operated over the absolute maximum ratings.

Recommended Operating Conditions (Ta=-40°C to +105°C, VSS=0V)

Parameter	Symbol	Ratings			Unit	Remarks
		Min	Typ	Max		
Power Supply Voltage1	VDD	2.5	-	6.0	V	Power Supply
Power Supply Voltage2	VLCD	2.5	-	6.0	V	LCD Drive Voltage

Electrical Characteristics

DC Characteristics (VDD=2.5V to 6.0V, VLCD=2.5V to 6.0V, VSS=0V, Ta=-40°C to 105°C, unless otherwise specified)

Parameter	Symbol	Limits			Unit	Conditions
		Min	Typ	Max		
"H" Level Input Voltage	VIH	0.7VDD	-	VDD	V	SDA, SCL, OSCIN, INHb
"L" Level Input Voltage	VIL	VSS	-	0.3VDD	V	SDA, SCL, OSCIN, INHb
"H" Level Input Current1	I _{IH1}	-	-	1	μA	SDA, SCL, OSCIN ^(Note2) , INHb
"L" Level Input Current1	I _{IL1}	-1	-	-	μA	SDA, SCL, OSCIN, INHb, TEST1
"H" Level Input Current2	I _{IH2}	-	-	300	μA	TEST1
SDA "L" Level Output Voltage	VOL_SDA	0	-	0.4	V	I _{load} = 3mA
LCD Driver on Resistance	SEG	RON	-	3	kΩ	I _{load} =±10μA
	COM	RON	-	3	kΩ	
Standby Current	I _{st}	-	-	5	μA	Display off, Oscillation off
Power Consumption 1	I _{DD}	-	2.5	15	μA	VDD=3.3V, VLCD=5V, Ta=25°C Power save mode1, FR=71Hz 1/3 bias, Frame inverse
Power Consumption 2	I _{LCD}	-	10	20	μA	VDD=3.3V, VLCD=5V, Ta=25°C Power save mode1, FR=71Hz 1/3 bias, Frame inverse

(Note2) For external clock mode only

Electrical Characteristics – continued

Oscillation Characteristics

(VDD=2.5 to 6.0V, VLCD=2.5 to 6.0V, VSS=0V, Ta=-40°C to +105°C, unless otherwise specified)

Parameter	Symbol	Limits			Unit	Conditions
		Min	Typ	Max		
Frame Frequency1	f _{CLK1}	56	80	112	Hz	FR = 80Hz setting, VDD=2.5V to 6.0V, Ta=-40°C to +105°C
Frame Frequency2	f _{CLK2}	70	80	90	Hz	FR = 80Hz setting, VDD=3.3V, Ta=25°C
Frame Frequency3	f _{CLK3}	77.5	87.5	97.5	Hz	FR = 80Hz setting, VDD=5.0V, Ta=25°C
Frame Frequency4	f _{CLK4}	67.5	87.5	108	Hz	FR = 80Hz setting, VDD=5.0V, Ta=-40°C to +105°C
External Clock Rise Time	t _r	-	-	0.3	μs	External clock mode (OSCIN) ^(Note)
External Clock Fall Time	t _f	-	-	0.3	μs	
External Frequency	f _{EXCLK}	15	-	300	KHz	
External Clock Duty	tdty	30	50	70	%	

(Note) <Frame frequency calculation at external clock mode>

DISCTL 80HZ setting: Frame frequency [Hz] = external clock [Hz] / 512

DISCTL 71HZ setting: Frame frequency [Hz] = external clock [Hz] / 576

DISCTL 64HZ setting: Frame frequency [Hz] = external clock [Hz] / 648

DISCTL 53HZ setting: Frame frequency [Hz] = external clock [Hz] / 768

【Reference Data】

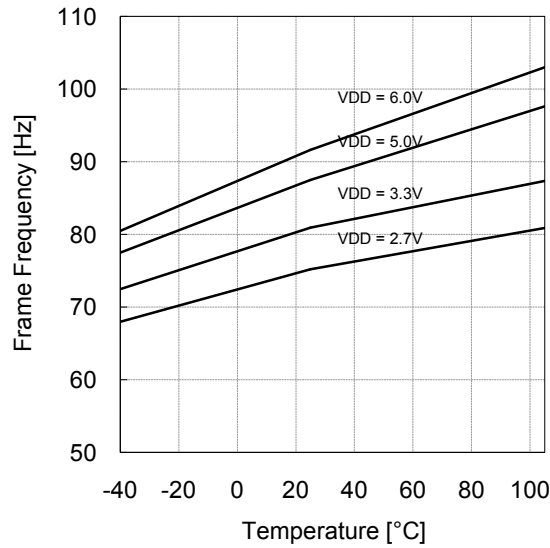

Figure 4. Typical Temperature Characteristics

Electrical Characteristics - continued

MPU interface Characteristics

(VDD=2.5V to 6.0V, VLCD=2.5V to 6.0V, VSS=0V, Ta=-40°C to 105°C, unless otherwise specified)

Parameter	Symbol	Limits			Unit	Conditions
		Min	Typ	Max		
Input Rise Time	tr	-	-	0.3	μs	
Input Fall Time	tf	-	-	0.3	μs	
SCL Cycle Time	tSCYC	2.5	-	-	μs	
"H" SCL Pulse Width	tSHW	0.6	-	-	μs	
"L" SCL Pulse Width	tSLW	1.3	-	-	μs	
SDA Setup Time	tSDS	100	-	-	ns	
SDA Hold Time	tSDH	100	-	-	ns	
Buss Free Time	tBUF	1.3	-	-	μs	
START Condition Hold Time	tHD;STA	0.6	-	-	μs	
START Condition Setup Time	tSU;STA	0.6	-	-	μs	
STOP Condition Setup Time	tSU;STO	0.6	-	-	μs	

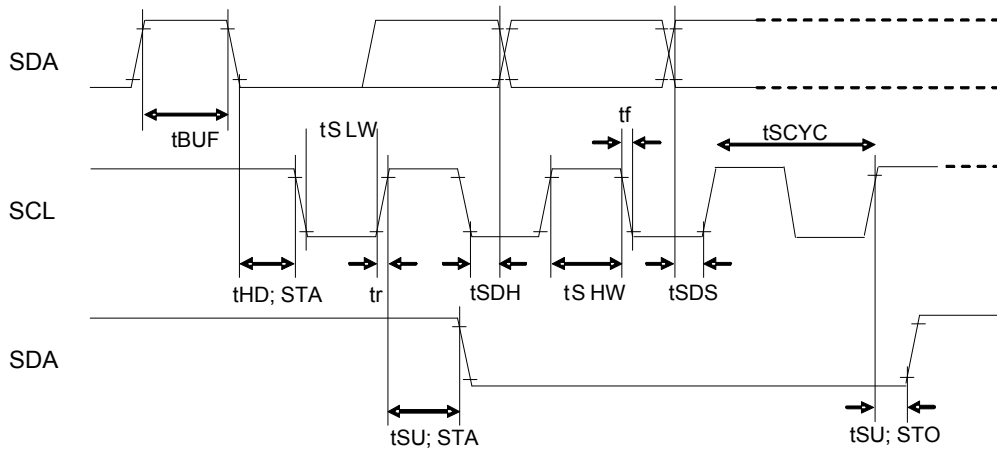

Figure 5. Interface Timing

I/O Equivalence Circuit

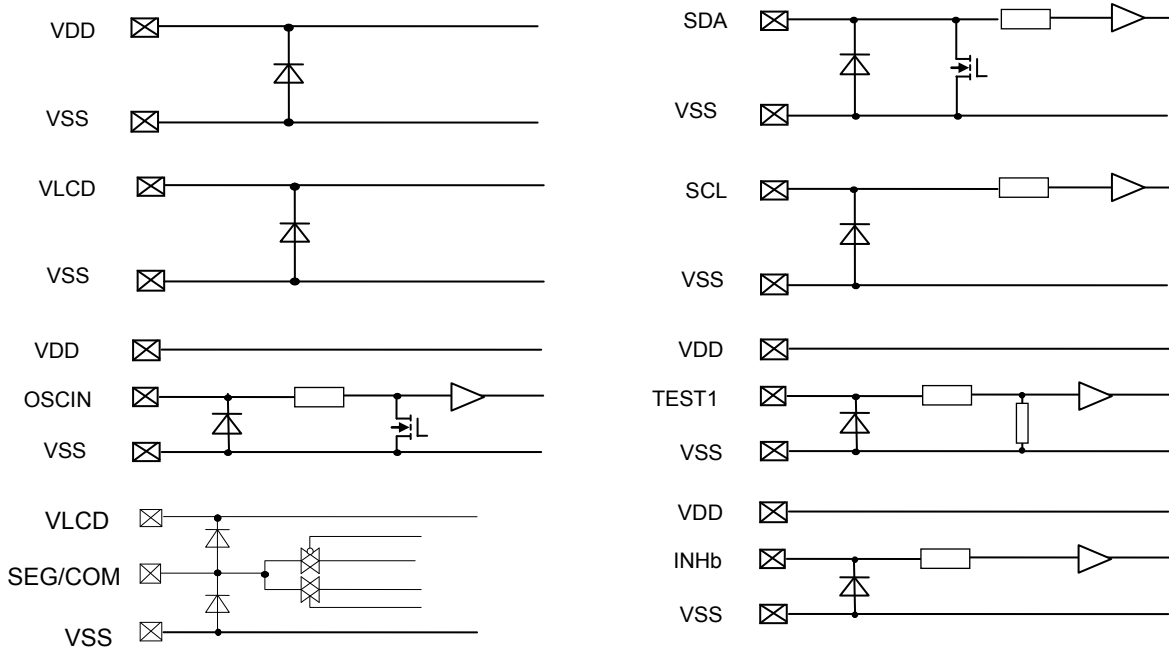
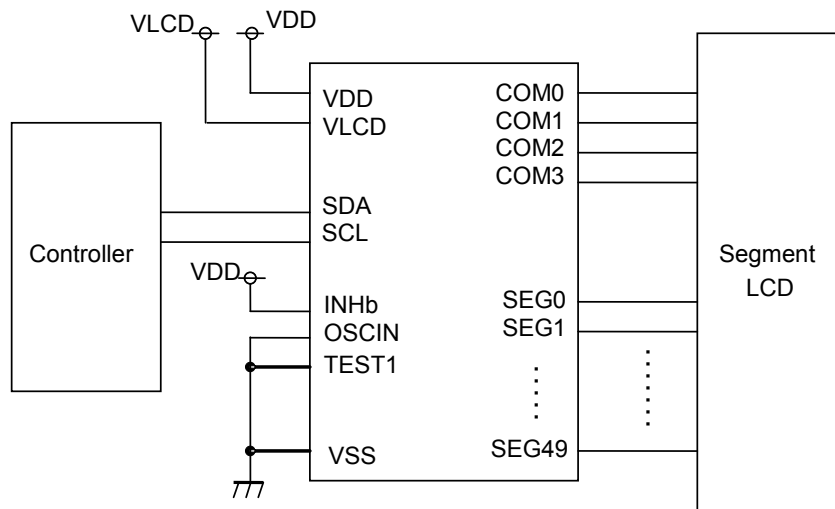
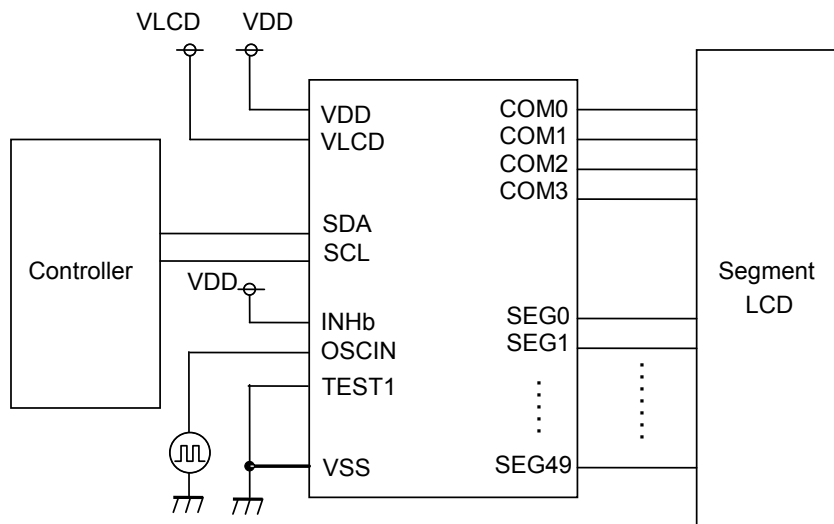

Figure 6. I/O Equivalence Circuit

Application Example



Internal Clock Mode



External Clock Mode

Figure 7. Example of Application Circuit

Functional Descriptions

Command /Data Transfer Method

BU91799KV-M is controlled by 2-wire signal (SDA, SCL).

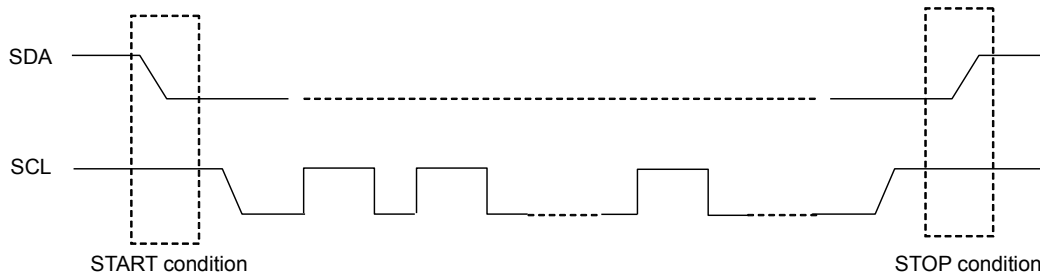

Figure 8. 2-SPI Command/Data Transfer Format

It is necessary to generate START and STOP condition when sending command or display data through this 2 wire serial interface.

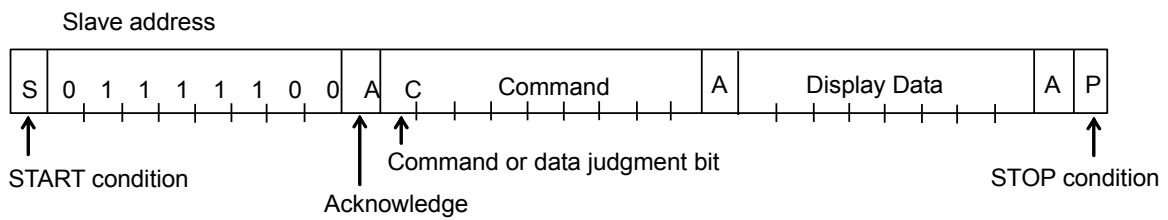

Figure 9. Interface Protocol

The following procedure shows how to transfer command and display data.

- (1) Generate "START condition".
- (2) Issue Slave address.
- (3) Transfer command and display data.
- (4) Generate "STOP condition"

Acknowledge

Data format is comprised of 8 bits, Acknowledge bit is returned after sending 8-bit data.

After the transfer of 8-bit data (Slave Address, Command, Display Data), release the SDA line at the falling edge of the 8th clock. The SDA line is then pulled "Low" until the falling edge of the 9th clock SCL.

(Output cannot be pulled "High" because of open drain NMOS).

If acknowledge function is not required, keep SDA line at "Low" level from 8th falling edge to 9th falling edge of SCL.

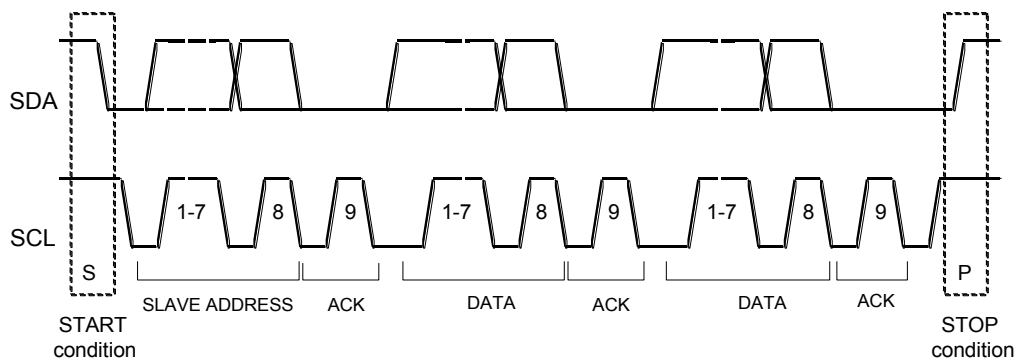
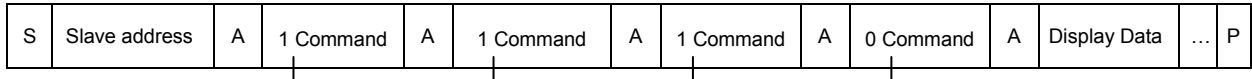

Figure 10. Acknowledge Timing

Command Transfer Method

Issue Slave Address (“01111100”) after generate “START condition”.
 The 1st byte after Slave Address always becomes command input.
 MSB (“command or data judge bit”) of command decide to next data is command or display data.
 When set “command or data judge bit”=‘1’, next byte will be command.
 When set “command or data judge bit”=‘0’, next byte data is display data.



It cannot accept input command once it enters into display data transfer state.
 In order to input command again it is necessary to generate “START condition”.
 If “START condition” or “STOP condition” is sent in the middle of command transmission, command will be cancelled.
 If Slave address is continuously sent following “START condition”, it remains in command input state.
 “Slave address” must be sent right after the “START condition”.
 When Slave Address cannot be recognized in the first data transmission, no Acknowledge bit is generated and next transmission will be invalid. When data is invalid status, if “START condition” is transmitted again, it will return to valid status.

Consider the MPU interface characteristic such as Input rise time and Setup/Hold time when transferring command and data (Refer to MPU Interface).

Write Display and Transfer Method

BU91799KV-M has Display Data RAM (DDRAM) of 50×4=200bits.
 The relationship between data input and display data, DDRAM data and address are as follows;

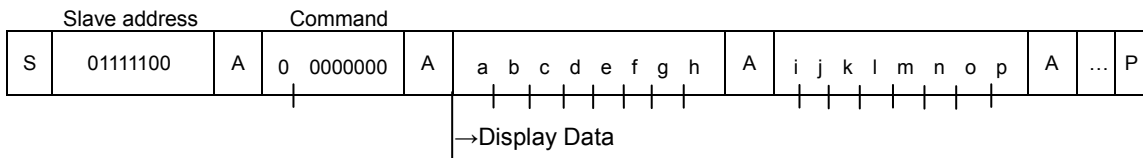

8-bit data is stored in DDRAM. ADSET command specifies the address to be written, and address is automatically incremented in every 4-bit data.
 Data can be continuously written in DDRAM by transmitting data continuously.
 When RAM data is written successively, after writing RAM data to 31h (SEG49), the address is returned to 00h (SEG0) by the auto-increment function

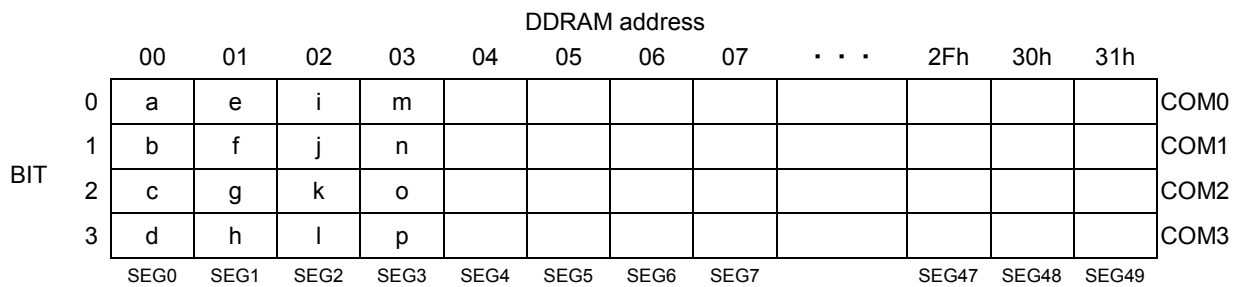

Display data is written to DDRAM every 4-bit data.
 No need to wait for ACK bit to complete data transfer.

Oscillator

The clock signals for logic and analog circuit can be generated from internal oscillator or external clock. If internal oscillator circuit is used, OSCIN must be connected to VSS level. When using external clock mode, input external clock from OSCIN terminal after ICSET command setting.

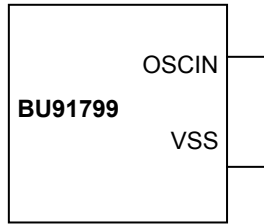

Figure 11. Internal Clock Mode

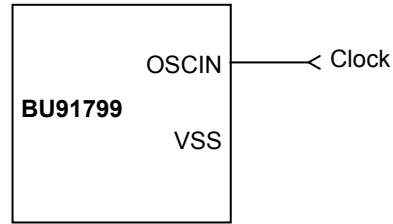

Figure 12. External Clock Mode

LCD Driver Bias Circuit

BU91799KV-M generates LCD driving voltage with on-chip Buffer AMP. And it can drive LCD at low power consumption. 1/3 or 1/2 Bias can be set by MODESET command. Line or frame inversion can be set by DISCTL command. Refer to the "LCD driving waveform" for each LCD bias setting.

Blink Timing Generator

BU91799KV-M has Blink function. Blink mode is asserted by BLKCTL command. The Blink frequency varies depending on fCLK characteristics at internal clock mode. Refer to Oscillation Characteristics for fCLK.

Reset Initialize Condition

Initial condition after execute Software Reset is as follows.

- Display is OFF.
- DDRAM address is initialized (DDRAM Data is not initialized).

Refer to Command Description for initialize value of registers.

Command / Function List

Description List of Command / Function

No.	Command	Function
1	Mode Set (MODESET)	Display on/off, 1/2bias or 1/3bias setting
2	Address Set (ADSET)	DDRAM address setting (00h to 31h)
3	Display Control (DISCTL)	Frame frequency, power save mode setting
4	Set IC Operation (ICSET)	Software reset, internal/external clock setting (P2 is MSB data of DDRAM address)
5	Blink Control (BLKCTL)	Blink off/0.5s/1s/2s blink setting
6	All Pixel Control (APCTL)	All pixels on/off during DISPON
7	EVR Set 1 (EVRSET1)	Set EVR 1
8	EVR Set 2 (EVRSET2)	Set EVR 2

Detailed Command Description

D7 (MSB) is a command or data judgment bit.
 Refer to Command and data transfer method.

C: 0: Next byte is RAM write data.
 1: Next byte is command.

Mode Set (MODESET)

MSB							LSB
D7	D6	D5	D4	D3	D2	D1	D0
C	1	0	0	P3	P2	*	*

(* : Don't care)

Set display ON and OFF

Setup	P3	Reset initialize condition
Display OFF (DISPOFF)	0	○
Display ON (DISPON)	1	

Display OFF : Regardless of DDRAM data, all SEGMENT and COMMON output will be stopped after 1frame off data write. Display OFF mode will be disabled after Display ON command.

Display ON : SEGMENT and COMMON output will be active and start to read the display data from DDRAM.

Set bias level

Setup	P2	Reset initialize condition
1/3 Bias	0	○
1/2 Bias	1	

Refer to LCD driving waveform

Address Set (ADSET)

MSB							LSB
D7	D6	D5	D4	D3	D2	D1	D0
C	0	0	P4	P3	P2	P1	P0

The range of address can be set from 000000 to 110001(bin).

	MSB					LSB
Internal register	Address [5]	Address [4]	Address [3]	Address [2]	Address [1]	Address [0]
Command	ICSET P2	ADSET P4	ADSET P3	ADSET P2	ADSET P1	ADSET P0

Address [5:0]: MSB bit is specified in ICSET P2 and [4:0] are specified as ADSET P4 - P0.
 Don't set out of range address, otherwise address will be set 00000.

Display Control (DISCTL)

MSB				LSB			
D7	D6	D5	D4	D3	D2	D1	D0
C	0	1	P4	P3	P2	P1	P0

Set Power save mode FR

Power save mode FR	P4	P3	Reset initialize condition
Normal mode (80Hz)	0	0	○
Power save mode1 (71Hz)	0	1	
Power save mode2 (64Hz)	1	0	
Power save mode3 (50Hz)	1	1	

Power consumption is reduced in the following order:

Normal mode > Power save mode1 > Power save mode 2 > Power save mode 3.

Set LCD drive waveform

Setup	P2	Reset initialize condition
Line inversion	0	○
Frame inversion	1	

Power consumption is reduced in the following order:

Line inversion > Frame inversion

Typically, when driving large capacitance LCD, Line inversion will increase the influence of crosstalk.

Regarding driving waveform, refer to LCD driving waveform.

Set Power save mode SR

Setup	P1	P0	Reset initialize condition
Power save mode1	0	0	
Power save mode2	0	1	
Normal mode	1	0	○
High power mode	1	1	

Power consumption is increased in the following order:

Power save mode 1 < Power save mode 2 < Normal mode < High power mode

(Reference current consumption data)

Setup	Current consumption
Power save mode 1	×0.6
Power save mode 2	×0.8
Normal mode	×1.0
High power mode	×1.2

The data above is for reference only. Actual consumption depends on Panel load.

Set IC Operation (ICSET)

MSB							LSB	
D7	D6	D5	D4	D3	D2	D1	D0	
C	1	1	0	1	P2	P1	P0	

P2: MSB data of DDRAM address. Refer to “ADSET” command.

Set software reset execution

Setup	P1
No operation	0
Software Reset Execute	1

When “Software Reset” is executed, BU91799KV-M is reset to initial condition. (Refer to Reset initialize condition)

Don't set Software Reset (P1) with P2, P0 at the same time.

Set oscillator mode

Setup	P0	Reset initialize condition
Internal clock	0	○
External clock	1	

Internal clock mode: OSCIN must be connected to VSS level.

External clock mode: Input external clock from OSCIN terminal..

<Frame frequency Calculation at external clock mode>

DISCTL 80Hz setting: Frame frequency [Hz] = external clock [Hz] / 512

DISCTL 71Hz setting: Frame frequency [Hz] = external clock [Hz] / 576

DISCTL 64Hz setting: Frame frequency [Hz] = external clock [Hz] / 648

DISCTL 53Hz setting: Frame frequency [Hz] = external clock [Hz] / 768

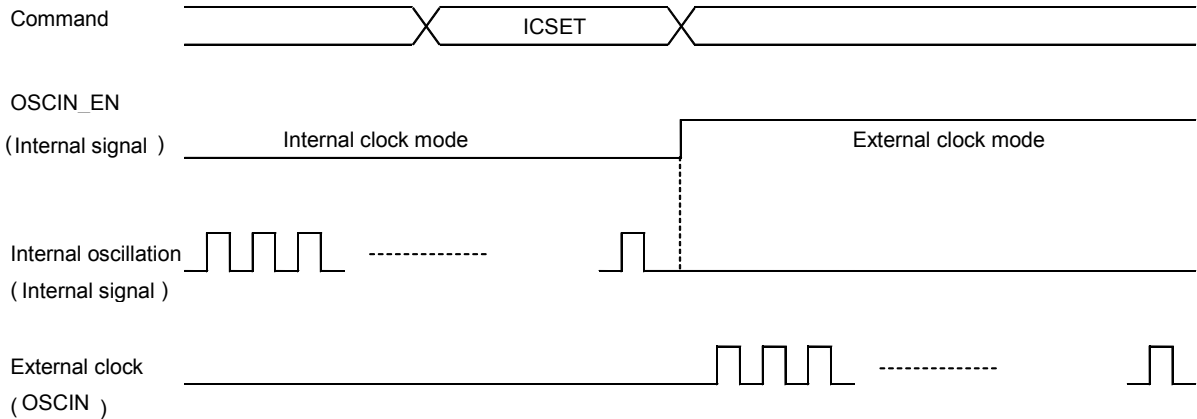

Figure 13. OSC MODE Switch Timing

Blink Control (BLKCTL)

MSB							LSB	
D7	D6	D5	D4	D3	D2	D1	D0	
C	1	1	1	0	*	P1	P0	

(* : Don't care)

Set blink mode

Blink mode (Hz)	P1	P0	Reset initialize condition
OFF	0	0	○
0.5	0	1	
1	1	0	
2	1	1	

The Blink frequency varies depending on fCLK characteristics at internal clock mode. Refer to Oscillation Characteristics for fCLK.

All Pixel Control (APCTL)

	MSB						LSB	
	D7	D6	D5	D4	D3	D2	D1	D0
C	1	1	1	1	1	1	P1	P0

All display set ON, OFF

Setup	P1	Reset initialize condition
Normal	0	○
All pixel ON (APON)	1	

Setup	P0	Reset initialize condition
Normal	0	○
All pixel OFF (APOFF)	1	

All pixels ON: All pixels are ON regardless of DDRAM data.
 All pixels OFF: All pixels are OFF regardless of DDRAM data.

This command is valid in Display on status. The data of DDRAM is not changed by this command.
 If set both P1 and P0 = "1", APOFF will be selected.

EVR Set 1 (EVRSET1)

	MSB						LSB	
	D7	D6	D5	D4	D3	D2	D1	D0
C	1	1	0	0	P2	P1	P0	

BU91799KV-M has 32-step Electrical Volume Register (EVR) that can set the best V0 voltage level (maximum LCD driving voltage).

Electrical Volume Register (EVR) setting is shown below.

	MSB			LSB	
Internal register	EVR4	EVR3	EVR2	EVR1	EVR0
Command	EVRSET1 P2	EVRSET1 P1	EVRSET1 P0	EVRSET2 P1	EVRSET2 P0
Reset initialize condition	0	0	0	0	0

Electrical Volume Register (EVR) is set to "00000" in reset initialize condition.
 In "00000" condition, V0 output voltage is equal to VLCD input voltage.
 Refer to The Relationship of Electrical Volume Register (EVR) Setting and V0 voltage.
 Keep EVR setting for V0 voltage more than 2.5V only.
 EVRSET1 command defines the upper 3bit of EVR.
 EVR setting is reflected by sending EVRSET1 command.

EVR Set 2 (EVRSET2)

	MSB						LSB	
	D7	D6	D5	D4	D3	D2	D1	D0
C	1	1	1	1	1	0	P1	P0

EVRSET2 command defines the lower 2bit of EVR.
 EVR setting is reflected by sending by sending EVRSET2 command.

The Relationship of Electrical Volume Register (EVR) Setting and V0 voltage

EVR	Calculation formula	VLCD = 6.000	VLCD = 5.500	VLCD = 5.000	VLCD = 4.000	VLCD = 3.500	VLCD = 3.000	VLCD = 2.500	[V]
0	VLCD	V0= 6.000	V0= 5.500	V0= 5.000	V0= 4.000	V0= 3.500	V0= 3.000	V0= 2.500	[V]
1	0.967*VLCD	V0= 5.802	V0= 5.323	V0= 4.839	V0= 3.871	V0= 3.387	V0= 2.903	V0= 2.419	[V]
2	0.937*VLCD	V0= 5.622	V0= 5.156	V0= 4.688	V0= 3.750	V0= 3.281	V0= 2.813	V0= 2.344	[V]
3	0.909*VLCD	V0= 5.454	V0= 5.000	V0= 4.545	V0= 3.636	V0= 3.182	V0= 2.727	V0= 2.273	[V]
4	0.882*VLCD	V0= 5.292	V0= 4.853	V0= 4.412	V0= 3.529	V0= 3.088	V0= 2.647	V0= 2.206	[V]
5	0.857*VLCD	V0= 5.142	V0= 4.714	V0= 4.286	V0= 3.429	V0= 3.000	V0= 2.571	V0= 2.143	[V]
6	0.833*VLCD	V0= 4.998	V0= 4.583	V0= 4.167	V0= 3.333	V0= 2.917	V0= 2.500	V0= 2.083	[V]
7	0.810*VLCD	V0= 4.860	V0= 4.459	V0= 4.054	V0= 3.243	V0= 2.838	V0= 2.432	V0= 2.027	[V]
8	0.789*VLCD	V0= 4.734	V0= 4.342	V0= 3.947	V0= 3.158	V0= 2.763	V0= 2.368	V0= 1.974	[V]
9	0.769*VLCD	V0= 4.614	V0= 4.231	V0= 3.846	V0= 3.077	V0= 2.692	V0= 2.308	V0= 1.923	[V]
10	0.750*VLCD	V0= 4.500	V0= 4.125	V0= 3.750	V0= 3.000	V0= 2.625	V0= 2.250	V0= 1.875	[V]
11	0.731*VLCD	V0= 4.386	V0= 4.024	V0= 3.659	V0= 2.927	V0= 2.561	V0= 2.195	V0= 1.829	[V]
12	0.714*VLCD	V0= 4.284	V0= 3.929	V0= 3.571	V0= 2.857	V0= 2.500	V0= 2.143	V0= 1.786	[V]
13	0.697*VLCD	V0= 4.182	V0= 3.837	V0= 3.488	V0= 2.791	V0= 2.442	V0= 2.093	V0= 1.744	[V]
14	0.681*VLCD	V0= 4.086	V0= 3.750	V0= 3.409	V0= 2.727	V0= 2.386	V0= 2.045	V0= 1.705	[V]
15	0.666*VLCD	V0= 3.996	V0= 3.667	V0= 3.333	V0= 2.667	V0= 2.333	V0= 2.000	V0= 1.667	[V]
16	0.652*VLCD	V0= 3.912	V0= 3.587	V0= 3.261	V0= 2.609	V0= 2.283	V0= 1.957	V0= 1.630	[V]
17	0.638*VLCD	V0= 3.828	V0= 3.511	V0= 3.191	V0= 2.553	V0= 2.234	V0= 1.915	V0= 1.596	[V]
18	0.625*VLCD	V0= 3.750	V0= 3.438	V0= 3.125	V0= 2.500	V0= 2.188	V0= 1.875	V0= 1.563	[V]
19	0.612*VLCD	V0= 3.672	V0= 3.367	V0= 3.061	V0= 2.449	V0= 2.143	V0= 1.837	V0= 1.531	[V]
20	0.600*VLCD	V0= 3.600	V0= 3.300	V0= 3.000	V0= 2.400	V0= 2.100	V0= 1.800	V0= 1.500	[V]
21	0.588*VLCD	V0= 3.528	V0= 3.235	V0= 2.941	V0= 2.353	V0= 2.059	V0= 1.765	V0= 1.471	[V]
22	0.576*VLCD	V0= 3.456	V0= 3.173	V0= 2.885	V0= 2.308	V0= 2.019	V0= 1.731	V0= 1.442	[V]
23	0.566*VLCD	V0= 3.396	V0= 3.113	V0= 2.830	V0= 2.264	V0= 1.981	V0= 1.698	V0= 1.415	[V]
24	0.555*VLCD	V0= 3.330	V0= 3.056	V0= 2.778	V0= 2.222	V0= 1.944	V0= 1.667	V0= 1.389	[V]
25	0.545*VLCD	V0= 3.270	V0= 3.000	V0= 2.727	V0= 2.182	V0= 1.909	V0= 1.636	V0= 1.364	[V]
26	0.535*VLCD	V0= 3.210	V0= 2.946	V0= 2.679	V0= 2.143	V0= 1.875	V0= 1.607	V0= 1.339	[V]
27	0.526*VLCD	V0= 3.156	V0= 2.895	V0= 2.632	V0= 2.105	V0= 1.842	V0= 1.579	V0= 1.316	[V]
28	0.517*VLCD	V0= 3.102	V0= 2.845	V0= 2.586	V0= 2.069	V0= 1.810	V0= 1.552	V0= 1.293	[V]
29	0.508*VLCD	V0= 3.048	V0= 2.797	V0= 2.542	V0= 2.034	V0= 1.780	V0= 1.525	V0= 1.271	[V]
30	0.500*VLCD	V0= 3.000	V0= 2.750	V0= 2.500	V0= 2.000	V0= 1.750	V0= 1.500	V0= 1.250	[V]
31	0.491*VLCD	V0= 2.946	V0= 2.705	V0= 2.459	V0= 1.967	V0= 1.721	V0= 1.475	V0= 1.230	[V]

 Prohibit setting

LCD Driving Waveform

(1/3bias)

Line Inversion

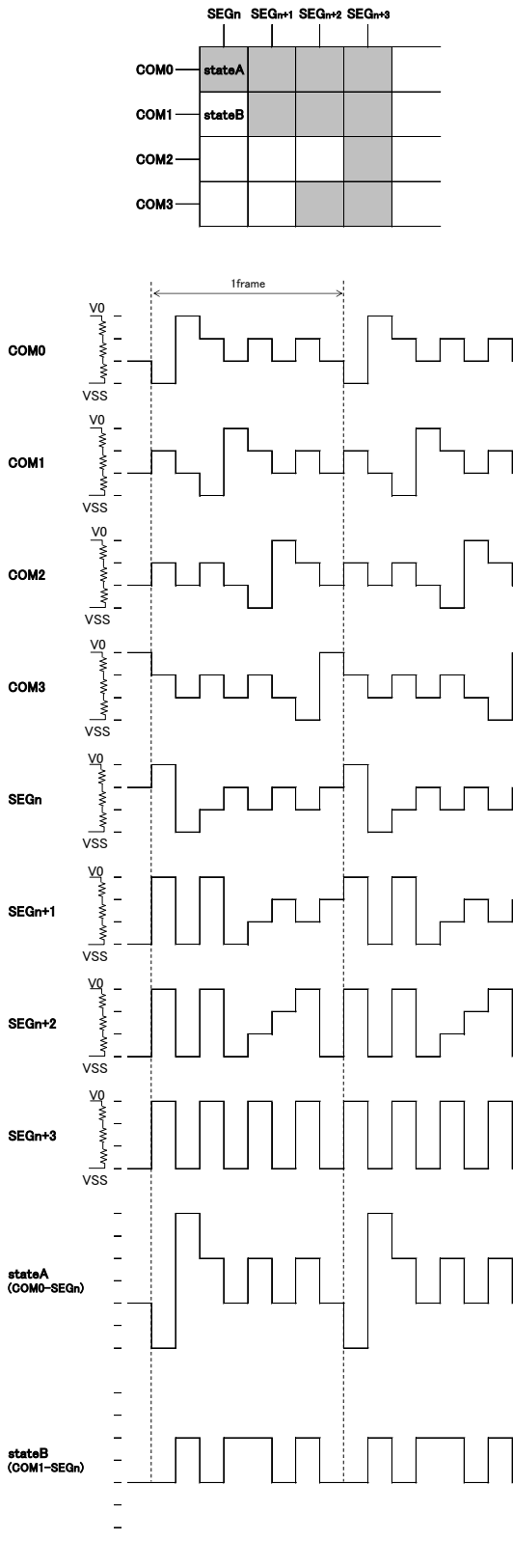

Figure 14. LCD Waveform in Line Inversion (1/3bias)

Frame Inversion

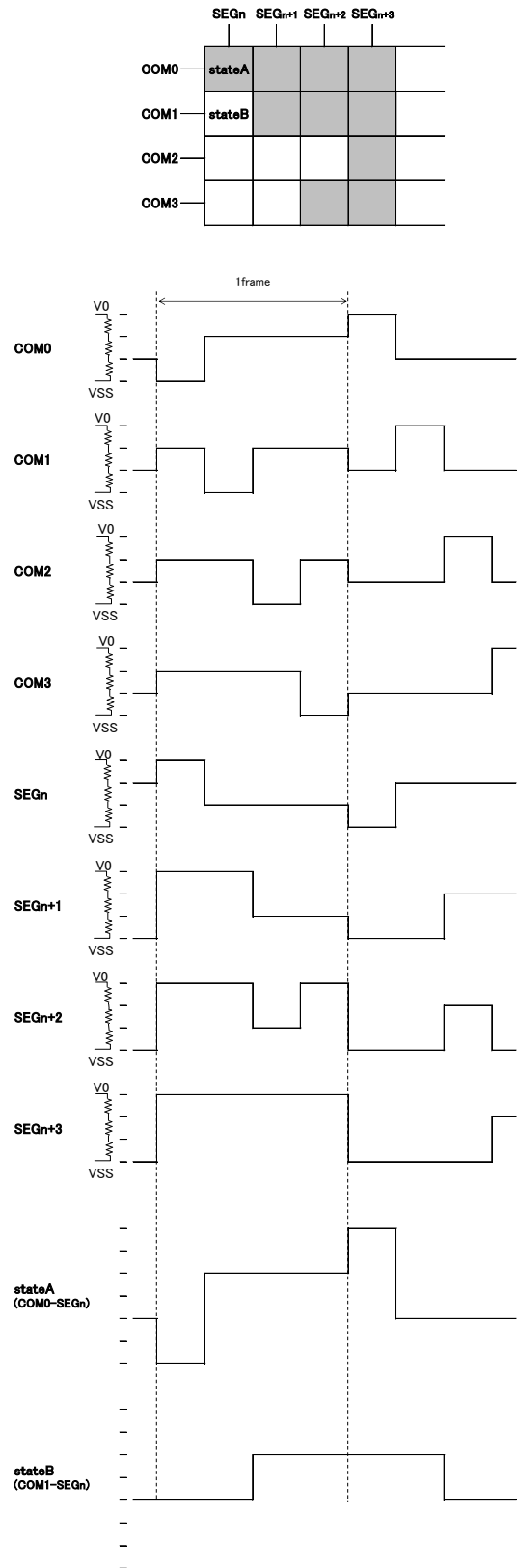

Figure 15. LCD Waveform in Frame Inversion (1/3bias)

(1/2bias)

Line Inversion

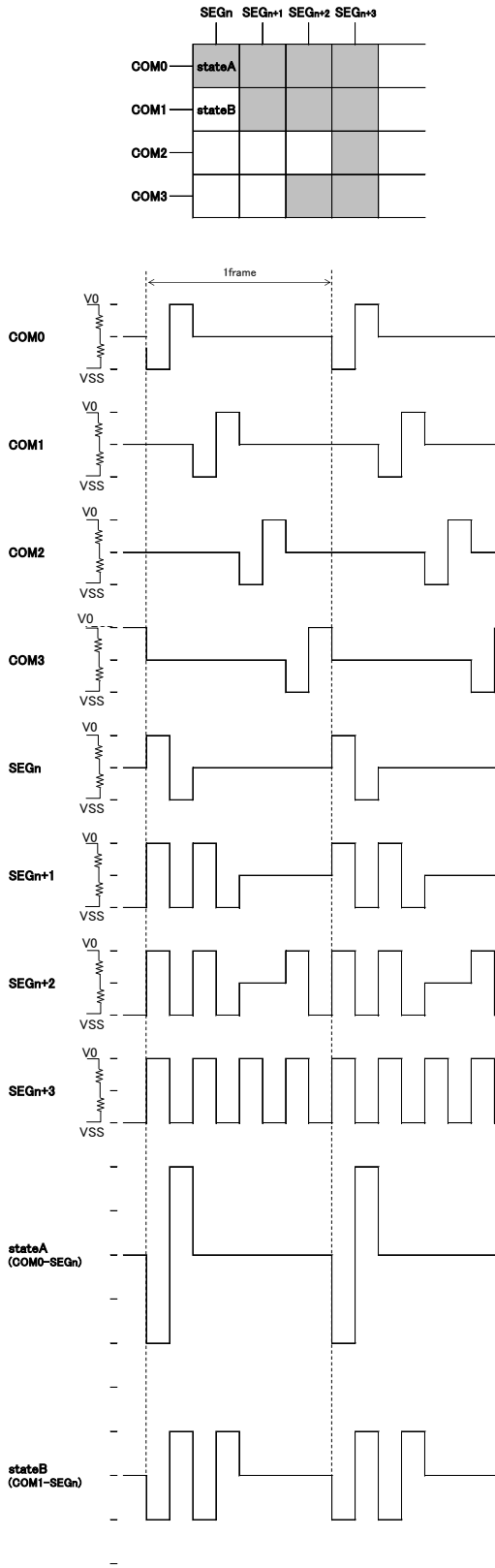

Figure 16. LCD Waveform in Line inversion (1/2bias)

Frame Inversion

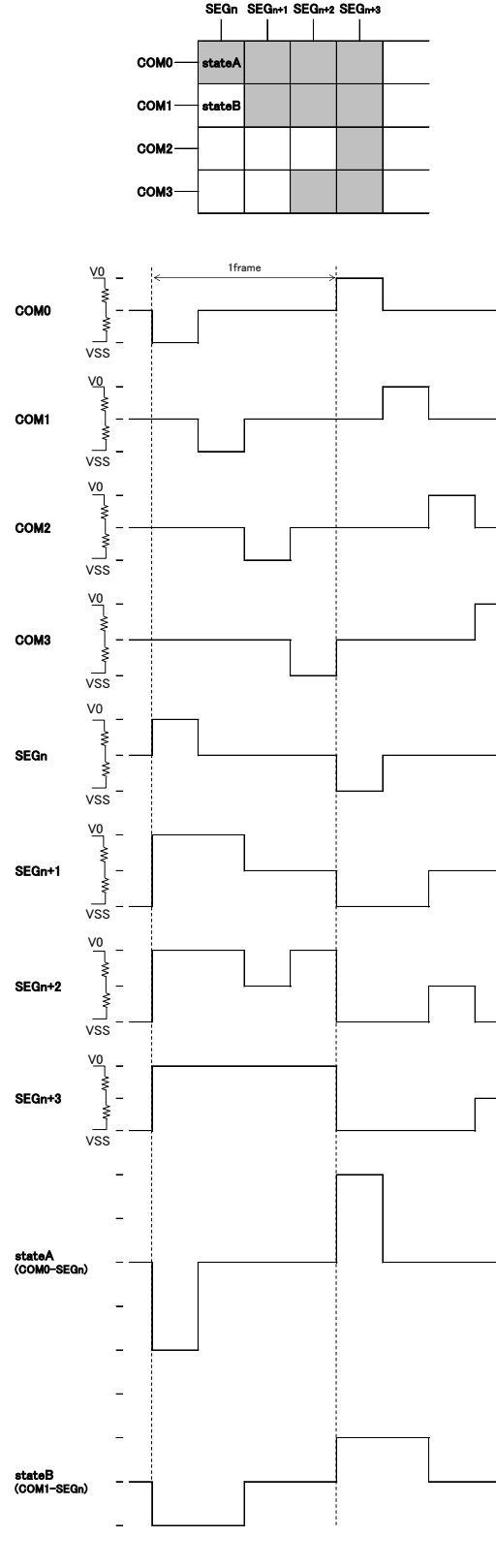

Figure 17. LCD Waveform in Frame Inversion (1/2bias)

Example of Display Data

If LCD layout pattern is like Figure 18 and Figure 19, and display pattern is like Figure20, display data will be shown as below.

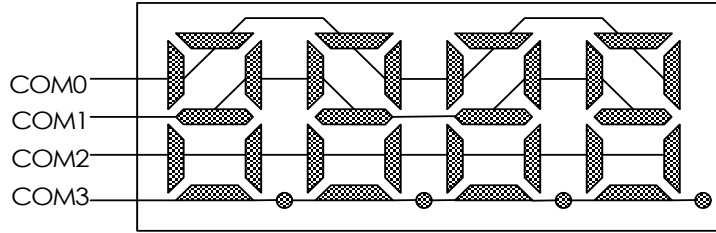

Figure 18. Example COM Line Pattern

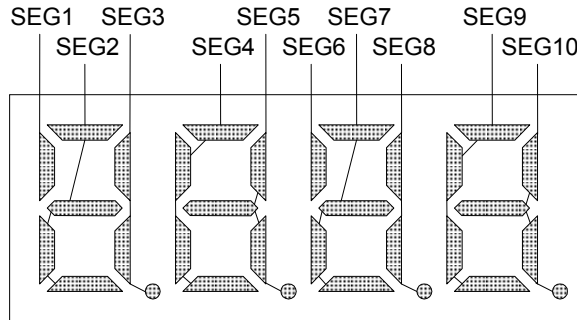

Figure 19. Example SEG Line Pattern

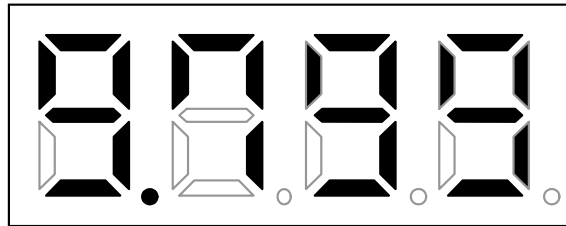

Figure 20. Example Display Pattern

<DDRAM data mapping in Figure 20 display pattern>

		S	S	S	S	S	S	S	S	S	S	S	S	S	S	S	S	S	S	S	S
		E	E	E	E	E	E	E	E	E	E	E	E	E	E	E	E	E	E	E	E
		G	G	G	G	G	G	G	G	G	G	G	G	G	G	G	G	G	G	G	G
		0	1	2	3	4	5	6	7	8	9	10	11	12	13	14	15	16	17	18	19
COM0	D0	0	1	1	0	1	1	1	1	0	1	1	0	0	0	0	0	0	0	0	0
COM1	D1	0	0	1	1	1	0	0	1	1	1	1	0	0	0	0	0	0	0	0	0
COM2	D2	0	0	0	1	0	1	0	0	1	0	1	0	0	0	0	0	0	0	0	0
COM3	D3	0	0	1	1	0	0	0	1	0	1	0	0	0	0	0	0	0	0	0	0
Address		00h	01h	02h	03h	04h	05h	06h	07h	08h	09h	0Ah	0Bh	0Ch	0Dh	0Eh	0Fh	10h	11h	12h	13h

Initialize Sequence

Follow the Power-on sequence below to initialize condition.

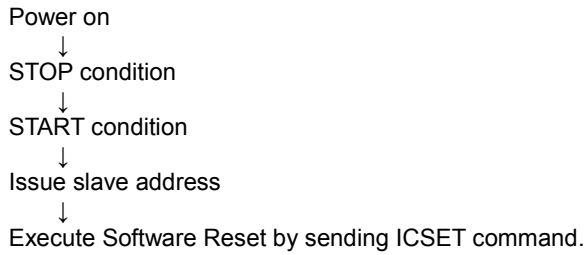

After Power-on and before sending initialize sequence, each register value, DDRAM address and DDRAM data are random.

Start Sequence

Start Sequence Example1

No.	Input	D7	D6	D5	D4	D3	D2	D1	D0	Descriptions
1	Power on									VDD=0→5V (Tr: Min 1ms to Max 500ms)
	↓									
2	wait 100μs									Initialize IC
	↓									
3	Stop									Stop condition
	↓									
4	Start									Start condition
	↓									
5	Slave address	0	1	1	1	1	1	0	0	Issue slave address
	↓									
6	ICSET	1	1	1	0	1	0	1	0	Software Reset
	↓									
7	BLKCTL	1	1	1	1	0	*	0	0	Blink OFF
	↓									
8	DISCTL	1	0	1	0	0	1	0	0	80Hz, Frame inv., Power save mode1
	↓									
9	EVRSET1	1	1	1	0	0	0	0	1	EVR: 001xx
10	EVRSET2	1	1	1	1	1	0	0	1	EVR: 00101
	↓									
11	ICSET	1	1	1	0	1	0	0	1	External clock input
	↓									
12	ADSET	0	0	0	0	0	0	0	0	RAM address set
	↓									
13	Display Data	*	*	*	*	*	*	*	*	address 00h - 01h
	Display Data	*	*	*	*	*	*	*	*	address 02h - 03h
	⋮									⋮
	Display Data	*	*	*	*	*	*	*	*	address 30h - 31h
	↓									
14	Stop									Stop condition
	↓									
15	Start									Start condition
	↓									
16	Slave address	0	1	1	1	1	1	0	0	Issue slave address
	↓									
17	MODESET	1	1	0	0	1	0	*	*	Display ON, 1/3bias
	↓									
18	Stop									Stop condition

(*: don't care)

Start Sequence Example2

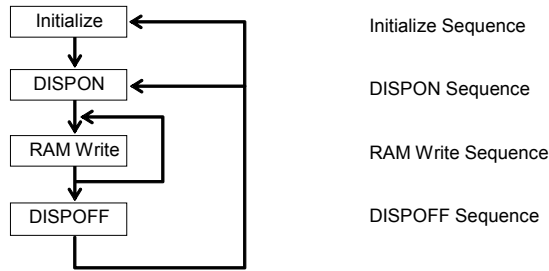

BU91799KV-M is initialized with Start Sequence, starts to display with “DISPON Sequence”, updates display data with “RAM Write Sequence” and stops the display with “DISPOFF Sequence”.
Execute “DISPON Sequence” in order to restart display.

Initialize Sequence

Input	DATA								Description
	D7	D6	D5	D4	D3	D2	D1	D0	
Power on									
wait 100us									
STOP									
START									
Slave address	0	1	1	1	1	1	0	0	Execute Software Reset Display OFF RAM address set Display data
ICSET	1	1	1	0	1	0	1	0	
MODESET	1	1	0	0	0	0	0	0	
ADSET	0	0	0	0	0	0	0	0	
Display data	*	*	*	*	*	*	*	*	
....									
STOP									

DISPON Sequence

Input	DATA								Description
	D7	D6	D5	D4	D3	D2	D1	D0	
START									
Slave address	0	1	1	1	1	1	0	0	Execute internal OSC mode Set Display Control Set BLKCTL Set APCTL Set EVR1 Set EVR2 Display ON
ICSET	1	1	1	0	1	0	0	1	
DISCTL	1	0	1	1	1	1	1	1	
BLKCTL	1	1	1	1	0	0	0	0	
APCTL	1	1	1	1	1	1	0	0	
EVRSET1	1	1	1	0	0	0	0	0	
EVRSET2	1	1	1	1	1	0	0	0	
MODESET	1	1	0	0	1	0	0	0	
STOP									

RAM Write Sequence

Input	DATA								Description
	D7	D6	D5	D4	D3	D2	D1	D0	
START									
Slave address	0	1	1	1	1	1	0	0	Execute internal OSC mode Set Display Control Set BLKCTL Set APCTL Set EVR1 Set EVR2 Display ON RAM address set Display data
ICSET	1	1	1	0	1	0	0	1	
DISCTL	1	0	1	1	1	1	1	1	
BLKCTL	1	1	1	1	0	0	0	0	
APCTL	1	1	1	1	1	1	0	0	
EVRSET1	1	1	1	0	0	0	0	0	
EVRSET2	1	1	1	1	1	0	0	0	
MODESET	1	1	0	0	1	0	0	0	
ADSET	0	0	0	0	0	0	0	0	
Display data	*	*	*	*	*	*	*	*	
....									
STOP									

DISPOF Sequence

Input	DATA								Description
	D7	D6	D5	D4	D3	D2	D1	D0	
START									
Slave address	0	1	1	1	1	1	0	0	Execute internal OSC mode Display OFF
ICSET	1	1	1	0	1	0	0	1	
MODESET	1	1	0	0	0	0	0	0	
STOP									

Abnormal operation may occur in BU91799KV-M due to the effect of noise or other external factor.
To avoid this phenomenon, it is highly recommended to input command according to sequence described above during initialization, display ON/OFF and refresh of RAM data.

Cautions in Power ON/OFF

Power Supply Sequence

To prevent incorrect display, malfunction and abnormal current, follow Power On/Off sequence shown in waveform below. VDD must be turned on before VLCD during power up sequence. VDD must be turned off after VLCD during power down sequence. Set $t1 > 0ns$ and $t2 > 0ns$.

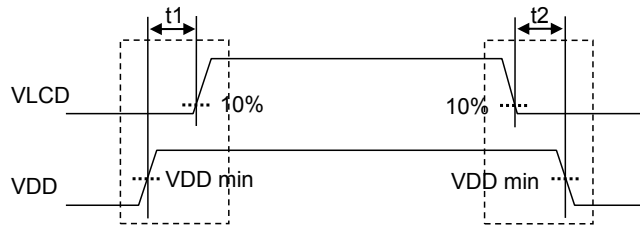
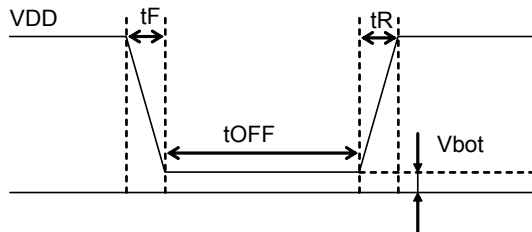

Figure 21. Power Supply Sequence

Caution in P.O.R Circuit Use

BU91799KV-M has "P.O.R" (Power-On Reset) circuit and Software Reset function. Keep the following recommended Power-On conditions in order to power up properly.

Set power up conditions to meet the recommended tR , tF , $tOFF$, and $Vbot$ specification below in order to ensure P.O.R operation. Set pin TEST1="L" to enable POR circuit.



Recommended condition of tR , tF , $tOFF$, $Vbot$ ($Ta=25^{\circ}C$)

$tR^{(Note)}$	$tF^{(Note)}$	$tOFF^{(Note)}$	$Vbot^{(Note)}$
1ms to 500ms	1ms to 500ms	Min 20ms	Less than 0.1V

(Note) This function is guaranteed by design, not tested in production process.

Figure 22. Power ON/OFF Waveform

If it is difficult to keep above conditions, execute the following sequence as quickly as possible after Power-On.

Setting TEST1="H" disables the POR circuit, in such case, execute the following sequence. Note however that it cannot accept command while supply is unstable or below the minimum supply range. Note also that software reset is not a complete alternative to POR function.

1. Generate STOP Condition

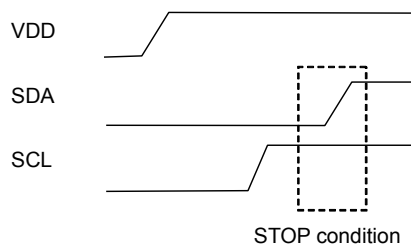

Figure 23. Stop Condition

2. Generate START Condition

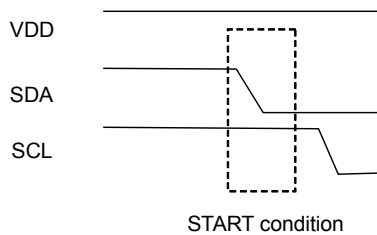

Figure 24. Start Condition

3. Issue Slave Address
4. Execute Software Reset (ICSET) Command

Operational Notes

1. Reverse Connection of Power Supply

Connecting the power supply in reverse polarity can damage the IC. Take precautions against reverse polarity when connecting the power supply, such as mounting an external diode between the power supply and the IC's power supply pins.

2. Power Supply Lines

Design the PCB layout pattern to provide low impedance supply lines. Separate the ground and supply lines of the digital and analog blocks to prevent noise in the ground and supply lines of the digital block from affecting the analog block. Furthermore, connect a capacitor to ground at all power supply pins. Consider the effect of temperature and aging on the capacitance value when using electrolytic capacitors.

3. Ground Voltage

Ensure that no pins are at a voltage below that of the ground pin at any time, even during transient condition.

4. Ground Wiring Pattern

When using both small-signal and large-current ground traces, the two ground traces should be routed separately but connected to a single ground at the reference point of the application board to avoid fluctuations in the small-signal ground caused by large currents. Also ensure that the ground traces of external components do not cause variations on the ground voltage. The ground lines must be as short and thick as possible to reduce line impedance.

5. Thermal Consideration

Should by any chance the power dissipation rating be exceeded the rise in temperature of the chip may result in deterioration of the properties of the chip. The absolute maximum rating of the Pd stated in this specification is when the IC is mounted on a 70mm x 70mm x 1.6mm glass epoxy board. In case of exceeding this absolute maximum rating, increase the board size and copper area to prevent exceeding the Pd rating.

6. Recommended Operating Conditions

These conditions represent a range within which the expected characteristics of the IC can be approximately obtained. The electrical characteristics are guaranteed under the conditions of each parameter.

7. Inrush Current

When power is first supplied to the IC, it is possible that the internal logic may be unstable and inrush current may flow instantaneously due to the internal powering sequence and delays, especially if the IC has more than one power supply. Therefore, give special consideration to power coupling capacitance, power wiring, width of ground wiring, and routing of connections.

8. Operation Under Strong Electromagnetic Field

Operating the IC in the presence of a strong electromagnetic field may cause the IC to malfunction.

9. Testing on Application Boards

When testing the IC on an application board, connecting a capacitor directly to a low-impedance output pin may subject the IC to stress. Always discharge capacitors completely after each process or step. The IC's power supply should always be turned off completely before connecting or removing it from the test setup during the inspection process. To prevent damage from static discharge, ground the IC during assembly and use similar precautions during transport and storage.

10. Inter-pin Short and Mounting Errors

Ensure that the direction and position are correct when mounting the IC on the PCB. Incorrect mounting may result in damaging the IC. Avoid nearby pins being shorted to each other especially to ground, power supply and output pin. Inter-pin shorts could be due to many reasons such as metal particles, water droplets (in very humid environment) and unintentional solder bridge deposited in between pins during assembly to name a few.

Operational Notes – continued**11. Unused Input Pins**

Input pins of an IC are often connected to the gate of a MOS transistor. The gate has extremely high impedance and extremely low capacitance. If left unconnected, the electric field from the outside can easily charge it. The small charge acquired in this way is enough to produce a significant effect on the conduction through the transistor and cause unexpected operation of the IC. So unless otherwise specified, unused input pins should be connected to the power supply or ground line.

12. Regarding the Input Pin of the IC

In the construction of this IC, P-N junctions are inevitably formed creating parasitic diodes or transistors. The operation of these parasitic elements can result in mutual interference among circuits, operational faults, or physical damage. Therefore, conditions which cause these parasitic elements to operate, such as applying a voltage to an input pin lower than the ground voltage should be avoided. Furthermore, do not apply a voltage to the input pins when no power supply voltage is applied to the IC. Even if the power supply voltage is applied, make sure that the input pins have voltages within the values specified in the electrical characteristics of this IC.

13. Data transmission

To refrain from data transmission is strongly recommended while power supply is rising up or falling down to prevent from the occurrence of disturbances on transmission and reception.

Ordering Information

B U 9 1 7 9 9 K V	-	M E 2
-------------------	---	-------

Part Number	Package KV : VQFP64	Product Rank M: for Automotive Packaging and forming specification E2: Embossed tape and reel
-------------	------------------------	--

Lineup

Package		Orderable Part Number
VQFP64	Reel of 1000	BU91799KV-ME2

Marking Diagram

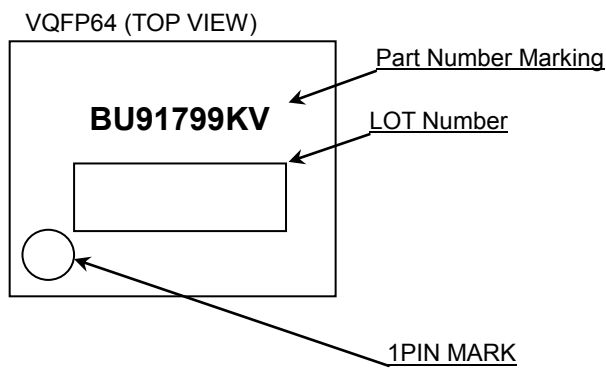

Physical Dimension, Tape and Reel Information

Package Name	VQFP64
--------------	--------

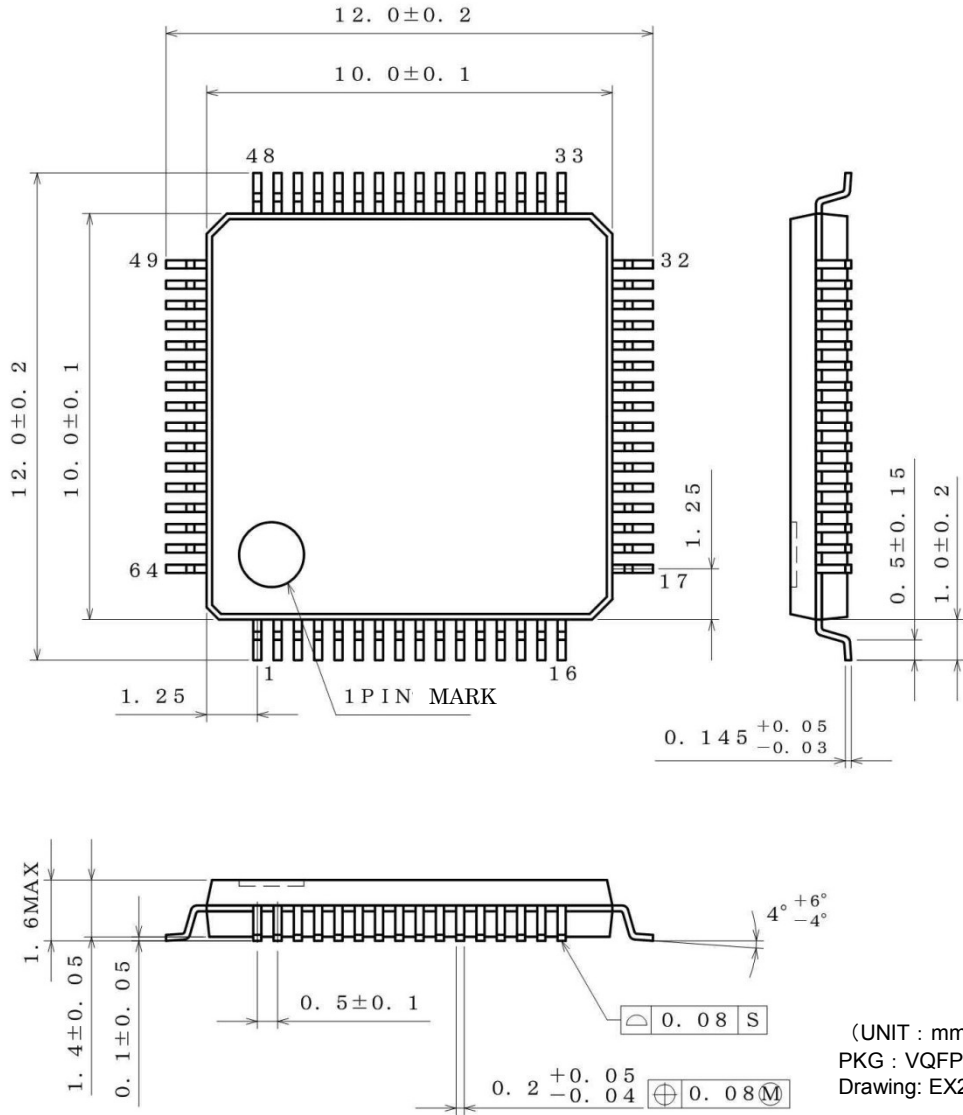

(UNIT : mm)
 PKG : VQFP64
 Drawing: EX252-5001-1

<Tape and Reel information>

Tape	Embossed carrier tape (with dry pack)
Quantity	1000pcs
Direction of feed	E2 (The direction is the 1pin of product is at the upper left when you hold reel on the left hand and you pull out the tape on the right hand)

* Order quantity needs to be multiple of the minimum quantity.

Revision History

Date	Revision	Changes
8.Feb.2016	001	First release

Notice

Precaution on using ROHM Products

1. If you intend to use our Products in devices requiring extremely high reliability (such as medical equipment ^(Note 1), aircraft/spacecraft, nuclear power controllers, etc.) and whose malfunction or failure may cause loss of human life, bodily injury or serious damage to property ("Specific Applications"), please consult with the ROHM sales representative in advance. Unless otherwise agreed in writing by ROHM in advance, ROHM shall not be in any way responsible or liable for any damages, expenses or losses incurred by you or third parties arising from the use of any ROHM's Products for Specific Applications.

(Note1) Medical Equipment Classification of the Specific Applications

JAPAN	USA	EU	CHINA
CLASS III	CLASS III	CLASS II b	CLASS III
CLASS IV		CLASS III	

2. ROHM designs and manufactures its Products subject to strict quality control system. However, semiconductor products can fail or malfunction at a certain rate. Please be sure to implement, at your own responsibilities, adequate safety measures including but not limited to fail-safe design against the physical injury, damage to any property, which a failure or malfunction of our Products may cause. The following are examples of safety measures:
 - [a] Installation of protection circuits or other protective devices to improve system safety
 - [b] Installation of redundant circuits to reduce the impact of single or multiple circuit failure
3. Our Products are not designed under any special or extraordinary environments or conditions, as exemplified below. Accordingly, ROHM shall not be in any way responsible or liable for any damages, expenses or losses arising from the use of any ROHM's Products under any special or extraordinary environments or conditions. If you intend to use our Products under any special or extraordinary environments or conditions (as exemplified below), your independent verification and confirmation of product performance, reliability, etc. prior to use, must be necessary:
 - [a] Use of our Products in any types of liquid, including water, oils, chemicals, and organic solvents
 - [b] Use of our Products outdoors or in places where the Products are exposed to direct sunlight or dust
 - [c] Use of our Products in places where the Products are exposed to sea wind or corrosive gases, including Cl₂, H₂S, NH₃, SO₂, and NO₂
 - [d] Use of our Products in places where the Products are exposed to static electricity or electromagnetic waves
 - [e] Use of our Products in proximity to heat-producing components, plastic cords, or other flammable items
 - [f] Sealing or coating our Products with resin or other coating materials
 - [g] Use of our Products without cleaning residue of flux (even if you use no-clean type fluxes, cleaning residue of flux is recommended); or Washing our Products by using water or water-soluble cleaning agents for cleaning residue after soldering
 - [h] Use of the Products in places subject to dew condensation
4. The Products are not subject to radiation-proof design.
5. Please verify and confirm characteristics of the final or mounted products in using the Products.
6. In particular, if a transient load (a large amount of load applied in a short period of time, such as pulse. is applied, confirmation of performance characteristics after on-board mounting is strongly recommended. Avoid applying power exceeding normal rated power; exceeding the power rating under steady-state loading condition may negatively affect product performance and reliability.
7. De-rate Power Dissipation depending on ambient temperature. When used in sealed area, confirm that it is the use in the range that does not exceed the maximum junction temperature.
8. Confirm that operation temperature is within the specified range described in the product specification.
9. ROHM shall not be in any way responsible or liable for failure induced under deviant condition from what is defined in this document.

Precaution for Mounting / Circuit board design

1. When a highly active halogenous (chlorine, bromine, etc.) flux is used, the residue of flux may negatively affect product performance and reliability.
2. In principle, the reflow soldering method must be used on a surface-mount products, the flow soldering method must be used on a through hole mount products. If the flow soldering method is preferred on a surface-mount products, please consult with the ROHM representative in advance.

For details, please refer to ROHM Mounting specification

Precautions Regarding Application Examples and External Circuits

1. If change is made to the constant of an external circuit, please allow a sufficient margin considering variations of the characteristics of the Products and external components, including transient characteristics, as well as static characteristics.
2. You agree that application notes, reference designs, and associated data and information contained in this document are presented only as guidance for Products use. Therefore, in case you use such information, you are solely responsible for it and you must exercise your own independent verification and judgment in the use of such information contained in this document. ROHM shall not be in any way responsible or liable for any damages, expenses or losses incurred by you or third parties arising from the use of such information.

Precaution for Electrostatic

This Product is electrostatic sensitive product, which may be damaged due to electrostatic discharge. Please take proper caution in your manufacturing process and storage so that voltage exceeding the Products maximum rating will not be applied to Products. Please take special care under dry condition (e.g. Grounding of human body / equipment / solder iron, isolation from charged objects, setting of Ionizer, friction prevention and temperature / humidity control).

Precaution for Storage / Transportation

1. Product performance and soldered connections may deteriorate if the Products are stored in the places where:
 - [a] the Products are exposed to sea winds or corrosive gases, including Cl₂, H₂S, NH₃, SO₂, and NO₂
 - [b] the temperature or humidity exceeds those recommended by ROHM
 - [c] the Products are exposed to direct sunshine or condensation
 - [d] the Products are exposed to high Electrostatic
2. Even under ROHM recommended storage condition, solderability of products out of recommended storage time period may be degraded. It is strongly recommended to confirm solderability before using Products of which storage time is exceeding the recommended storage time period.
3. Store / transport cartons in the correct direction, which is indicated on a carton with a symbol. Otherwise bent leads may occur due to excessive stress applied when dropping of a carton.
4. Use Products within the specified time after opening a humidity barrier bag. Baking is required before using Products of which storage time is exceeding the recommended storage time period.

Precaution for Product Label

A two-dimensional barcode printed on ROHM Products label is for ROHM's internal use only.

Precaution for Disposition

When disposing Products please dispose them properly using an authorized industry waste company.

Precaution for Foreign Exchange and Foreign Trade act

Since concerned goods might be fallen under listed items of export control prescribed by Foreign exchange and Foreign trade act, please consult with ROHM in case of export.

Precaution Regarding Intellectual Property Rights

1. All information and data including but not limited to application example contained in this document is for reference only. ROHM does not warrant that foregoing information or data will not infringe any intellectual property rights or any other rights of any third party regarding such information or data.
2. ROHM shall not have any obligations where the claims, actions or demands arising from the combination of the Products with other articles such as components, circuits, systems or external equipment (including software).
3. No license, expressly or implied, is granted hereby under any intellectual property rights or other rights of ROHM or any third parties with respect to the Products or the information contained in this document. Provided, however, that ROHM will not assert its intellectual property rights or other rights against you or your customers to the extent necessary to manufacture or sell products containing the Products, subject to the terms and conditions herein.

Other Precaution

1. This document may not be reprinted or reproduced, in whole or in part, without prior written consent of ROHM.
2. The Products may not be disassembled, converted, modified, reproduced or otherwise changed without prior written consent of ROHM.
3. In no event shall you use in any way whatsoever the Products and the related technical information contained in the Products or this document for any military purposes, including but not limited to, the development of mass-destruction weapons.
4. The proper names of companies or products described in this document are trademarks or registered trademarks of ROHM, its affiliated companies or third parties.

General Precaution

1. Before you use our Products, you are requested to carefully read this document and fully understand its contents. ROHM shall not be in any way responsible or liable for failure, malfunction or accident arising from the use of any ROHM's Products against warning, caution or note contained in this document.
2. All information contained in this document is current as of the issuing date and subject to change without any prior notice. Before purchasing or using ROHM's Products, please confirm the latest information with a ROHM sales representative.
3. The information contained in this document is provided on an "as is" basis and ROHM does not warrant that all information contained in this document is accurate and/or error-free. ROHM shall not be in any way responsible or liable for any damages, expenses or losses incurred by you or third parties resulting from inaccuracy or errors of or concerning such information.



BU91799KV-M - Web Page

Part Number	BU91799KV-M
Package	VQFP64
Unit Quantity	1000
Minimum Package Quantity	1000
Packing Type	Taping
Constitution Materials List	inquiry
RoHS	Yes