

SGS-THOMSON

30E D

HIGH VOLTAGE POWER DISSIPATION

- HIGH VOLTAGE POWER DARLINGTON
- AUTOMOTIVE IGNITION APPLICATIONS
- HIGH CURRENT

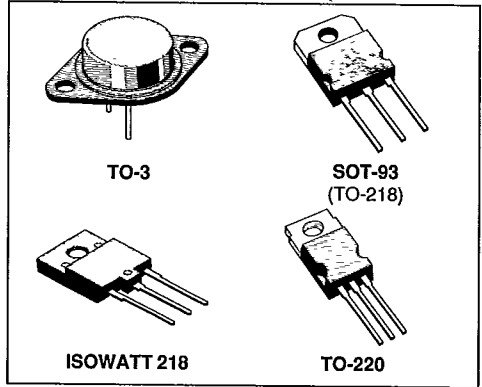

DESCRIPTION

The BU920/921/922, BU920P/921P/922P, BU920-PFI/BU921PFI/BU922PFI and BU920T/921T/922T are silicon multi-epitaxial planar NPN transistors in monolithic darlington configuration mounted respectively in Jedec TO-3 metal case, SOT-93 plastic package, ISOWATT218 fully isolated package and TO-220 plastic package.

They are particularly intended for automotive ignition applications and inverter circuits for motor control.

INTERNAL SCHEMATIC DIAGRAM

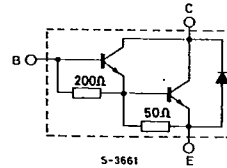

ABSOLUTE MAXIMUM RATINGS

Symbol	Parameter	Value				Unit
		TO-3 SOT-93 ISOWATT218 TO-220	BU920 BU920P BU920PFI BU920T	BU921 BU921P BU921PFI BU921T	BU922 BU922P BU922PFI BU922T	
V_{CES}	Collector-emitter Voltage ($V_{BE} = 0$)	400	450	500	V	
V_{CEO}	Collector-emitter Voltage ($I_B = 0$)	350	400	450	V	
V_{EBO}	Emitter-base Voltage ($I_C = 0$)		5		V	
I_C	Collector Current		10		A	
I_{CM}	Collector Peak Current		15		A	
I_B	Base Current		5		A	
		TO-3	SOT-93	ISOWATT218	TO-220	
P_{tot}	Total Dissipation at $T_c \leq 25^\circ C$	120	105	55	105	W
T_{stg}	Storage Temperature - 65 to	175	150	150	150	$^\circ C$
T_j	Max. Operating Junction Temperature	175	150	150	150	$^\circ C$

THERMAL DATA

			TO-3	SOT-93	ISOWATT218	TO-220	
R _{th j-case}	Thermal Resistance Junction-case	Max	1.25	1.2	2.27*	1.2	°C/W

T-33-29

ELECTRICAL CHARACTERISTICS (T_{case} = 25 °C unless otherwise specified)

Symbol	Parameter	Test Conditions	Min.	Typ.	Max.	Unit
I _{CES}	Collector Cutoff Current (V _{BE} = 0)	V _{CE} = 400 V for 920 Types			250	μA
		V _{CE} = 450 V for 921 Types			250	μA
		V _{CE} = 500 V for 922 Types			250	μA
		V _{CE} = 400 V for 920 Types			0.5	mA
		V _{CE} = 450 V for 921 Types			0.5	mA
		V _{CE} = 500 V for 922 Types			0.5	mA
I _{CEO}	Collector Cutoff Current (I _B = 0)	V _{CE} = 350 V for 920 Types			250	μA
		V _{CE} = 400 V for 921 Types			250	μA
		V _{CE} = 450 V for 922 Types			250	μA
I _{EBO}	Emitter Cutoff Current (I _C = 0)	V _{EB} = 5 V			50	mA
V _{CEO(sus)*}	Collector-emitter Sustaining Voltage	I _C = 100 mA for 920 Types	350			V
		I _C = 100 mA for 921 Types	400			V
		I _C = 100 mA for 922 Types	450			V
V _{CE(sat)*}	Collector-emitter Saturation Voltage	I _C = 5 A I _B = 50 mA			1.8	V
		I _C = 7 A I _B = 140 mA			1.8	V
V _{BE(sat)*}	Base-emitter Saturation Voltage	I _C = 5 A I _B = 50 mA			2.2	V
		I _C = 7 A I _B = 140 mA			2.5	V
V _F	Diode Forward Voltage	I _F = 7 A			2.5	V
	Functional Test (see test circuit Fig.2 and 3)	for 920 Types				
V _{CE} = 350 V L = 7 mH		7			A	
for 921 and 922 Types						
		V _{CE} = 400 V L = 7 mH	7			A

* Pulsed : pulse duration = 300 μs, duty cycle = 1.5 %.

Safe Operating Areas.

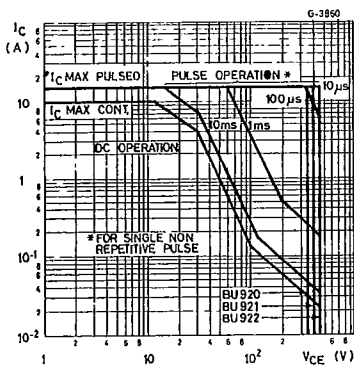

Safe Operating Areas.

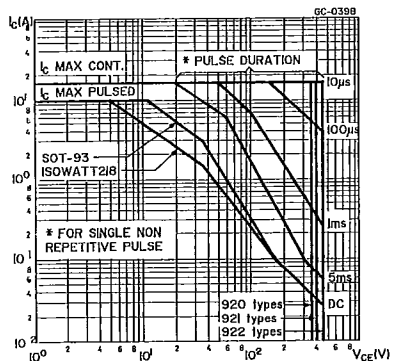

SGS-THOMSON

30E D

DC Current Gain.

Collector-emitter Saturation Voltage.

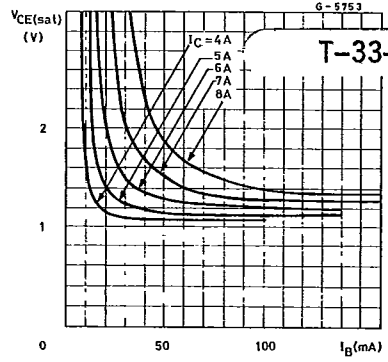
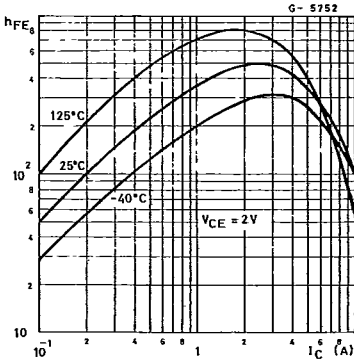

Collector-emitter Saturation Voltage.

Base-emitter Saturation Voltage.

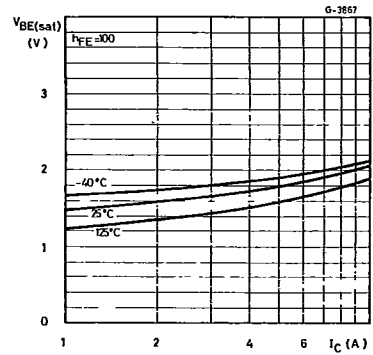
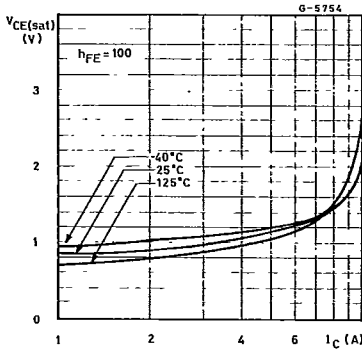

Collector-emitter Saturation Voltage.

Base-emitter Saturation Voltage.

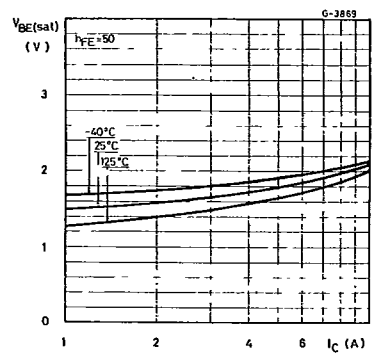
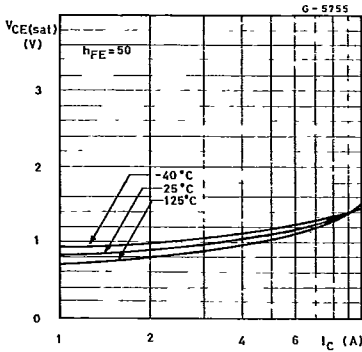

Saturated Switching Characteristics.

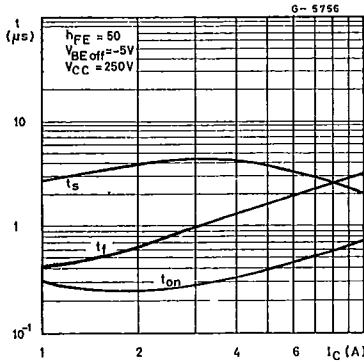
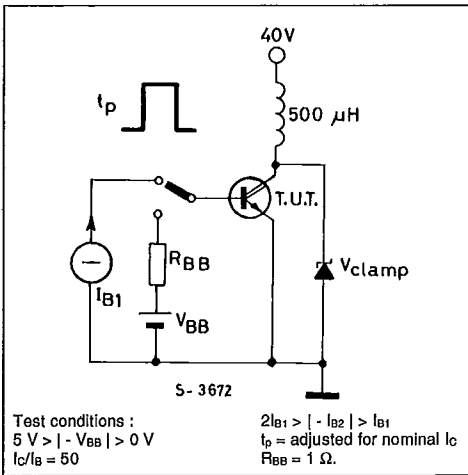

Figure 1 : Clamped $E_{s/o}$ Test Circuit.



Clamped Reverse Bias Safe Operating Areas.

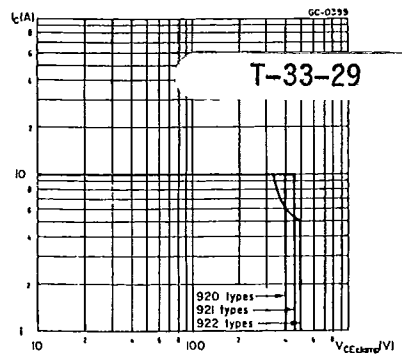

Figure 2 : Functional Test Circuit.

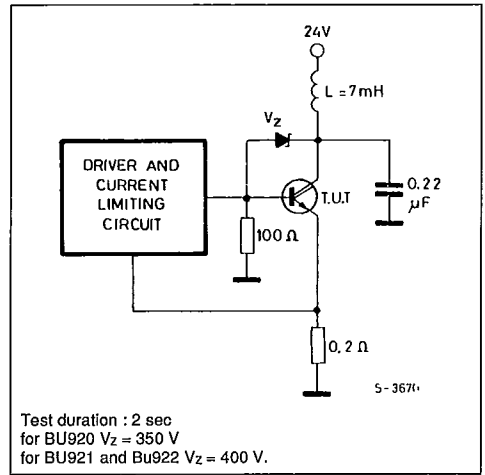
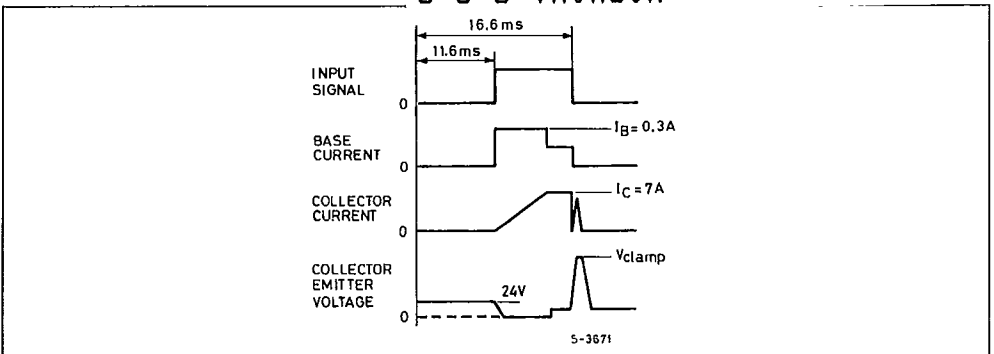

Figure 3 : Functional Test Waveforms.



S G S-THOMSON

30E D

ISOWATT 218 PACKAGE CHARACTERISTICS AND APPLICATION

ISOWATT218 is fully isolated to 4000 V dc. Its thermal impedance, given in the data sheet, is optimized to give efficient thermal conduction together with excellent electrical isolation.

The structure of the case ensures optimum distances between the pins and heatsink. These distances are in agreement with VDE and UL creepage and clearance standards. The ISOWATT218 package eliminates the need for external isolation so reducing fixing hardware.

The package is supplied with leads longer than the standard TO-218 to allow easy mounting on pcbs. Accurate moulding techniques used in manufacture assures consistent heat spreader-to-heatsink capacitance.

ISOWATT218 thermal performance is better than that of the standard part, mounted with a 0.1 mm mica washer. The thermally conductive plastic has a higher breakdown rating and is less fragile than mica or plastic sheets. Power derating for ISOWATT218 packages is determined by :

$$P_D = \frac{T_j - T_c}{R_{th}}$$

SGS-THOMSON

THERMAL IMPEDANCE OF ISOWATT 218 PACKAGE

Fig. 4 illustrates the elements contributing to the thermal resistance of transistor heatsink assembly, using ISOWATT218 package.

The total thermal resistance $R_{th(tot)}$ is the sum of each of these elements.

The transient thermal impedance, Z_{th} for different pulse durations can be estimated as follows :

1 - for a short duration power pulse less than 1 ms ;

$$Z_{th} = R_{thJ-C}$$

2 - for an intermediate power pulse of 5 ms to 50 ms :

$$Z_{th} = R_{thJ-C}$$

3 - for long power pulses of the order of 500 ms or greater :

$$Z_{th} = R_{thJ-C} + R_{thC-HS} + R_{thHS-amb}$$

It is often possible to discern these areas on transient thermal impedance curves.

Figure 4.

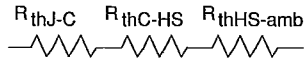

30E D