

isc Silicon NPN Darlington Power Transistor
BU922P
DESCRIPTION

- High Voltage
- Minimum Lot-to-Lot variations for robust device performance and reliable operation

APPLICATIONS

- Designed for automotive ignition applications and inverter circuits for motor control.

ABSOLUTE MAXIMUM RATINGS ($T_a=25^\circ\text{C}$)

SYMBOL	PARAMETER	VALUE	UNIT
V_{CES}	Collector-Emitter Voltage $V_{BE}=0$	500	V
V_{CEO}	Collector-Emitter Voltage	450	V
V_{EBO}	Emitter-Base Voltage	5	V
I_C	Collector Current	10	A
I_{CM}	Collector Current-peak	15	A
I_B	Base Current	5	A
P_C	Collector Power Dissipation @ $T_C=25^\circ\text{C}$	105	W
T_j	Junction Temperature	150	$^\circ\text{C}$
T_{stg}	Storage Temperature Range	-65~150	$^\circ\text{C}$

THERMAL CHARACTERISTICS

SYMBOL	PARAMETER	MAX	UNIT
$R_{th\ j-c}$	Thermal Resistance, Junction to Case	1.2	$^\circ\text{C/W}$

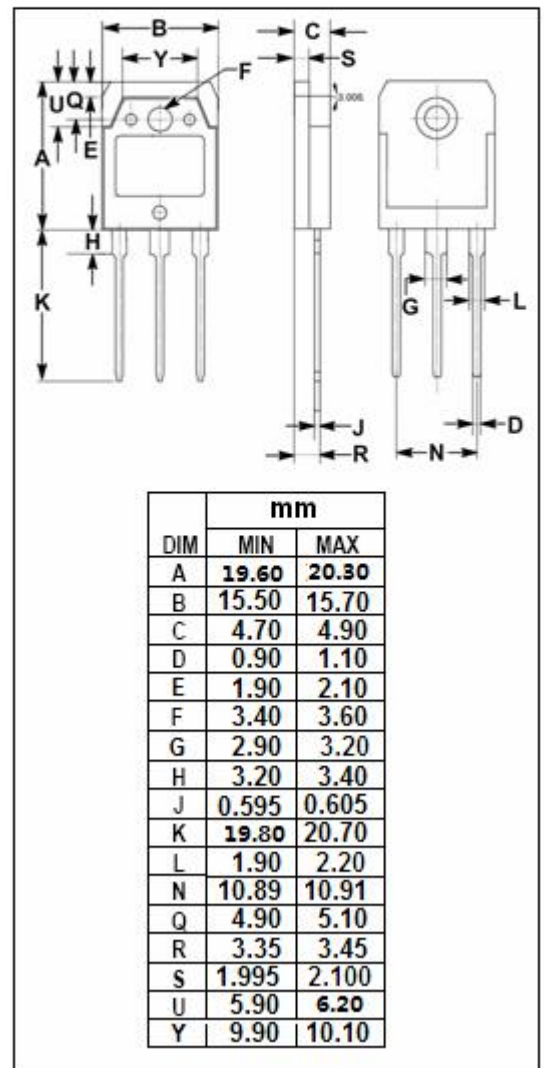
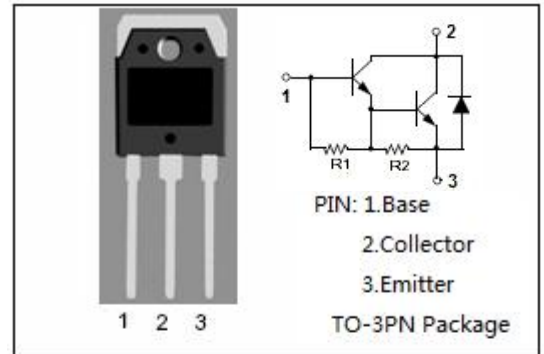

isc Silicon NPN Darlington Power Transistor

BU922P

ELECTRICAL CHARACTERISTICS

T_c=25°C unless otherwise specified

SYMBOL	PARAMETER	CONDITIONS	MIN	TYP.	MAX	UNIT
V _{CEO(SUS)}	Collector-Emitter Sustaining Voltage	I _C = 50mA; I _B = 0	450			V
V _{CE(sat)-1}	Collector-Emitter Saturation Voltage	I _C = 5A; I _B = 50mA			1.8	V
V _{CE(sat)-2}	Collector-Emitter Saturation Voltage	I _C = 7A; I _B = 140mA			1.8	V
V _{BE(sat)-1}	Base-Emitter Saturation Voltage	I _C = 5A; I _B = 50mA			2.2	V
V _{BE(sat)-2}	Base-Emitter Saturation Voltage	I _C = 7A; I _B = 140mA			2.5	V
I _{CES}	Collector Cutoff Current	V _{CE} = 500V; V _{BE} = 0 V _{CE} = 500V; V _{BE} = 0; T _J = 125°C			0.25 0.5	mA
I _{CEO}	Collector Cutoff Current	V _{CE} = 450V; I _B = 0			0.25	mA
I _{EBO}	Emitter Cutoff Current	V _{EB} = 5V; I _C = 0			50	mA
V _{ECF}	C-E Diode Forward Voltage	I _F = 7A			2.5	V

NOTICE:

ISC reserves the rights to make changes of the content herein the datasheet at any time without notification. The information contained herein is presented only as a guide for the applications of our products.

ISC products are intended for usage in general electronic equipment. The products are not designed for use in equipment which require specialized quality and/or reliability, or in equipment which could have applications in hazardous environments, aerospace industry, or medical field. Please contact us if you intend our products to be used in these special applications.

ISC makes no warranty or guarantee regarding the suitability of its products for any particular purpose, nor does ISC assume any liability arising from the application or use of any products, and specifically disclaims any and all liability, including without limitation special, consequential or incidental damages.