

Servo signal processor for CD

BU9312AKS

The BU9312AKS is a CD servo signal processing IC that contains a speed doubling unadjusted PLL, program servo, and signal processor, and that delivers low voltage operation and low power consumption. This IC is ideal for miniaturized, low-power-consumption applications.

●Applications

Portable CD players, portable stereos and mini component stereo systems

●Features

- 1) Internal PLL circuit, allowing EFM data demodulation and bit clock sampling with minimum attached components.
- 2) Frame synch signal detection and protection.
- 3) Internal focus, tracking and thread servo filters. Characteristics can be controlled with commands from the controller.
- 4) Subcode serial output pin.
- 5) Output pins for P code and Q code.
- 6) Internal CLV sequencer that automatically sets the CLV mode.
- 7) Internal track jump sequencer that jumps the desired number of tracks.
- 8) Single-chip IC with deinterleaving function and internal C1 / C2 double error detection, correction and flag processor.
- 9) Signals to DAC are output via MSB fast 2^{SCOMP} serial outputs, enabling control of ON / OFF operation of CD-ROM interpolators.
- 10) 16k bits of internal SRAM, for the storage of up to ± 4 frames of jitters.
- 11) Doubled-speed playback.

● Absolute maximum ratings (Ta = 25°C)

Parameter	Symbol	Limits	Unit
Power supply voltage	V _{cc}	7	V
Power dissipation	P _d	400*	mW
Operating temperature	T _{opr}	-25~+75	°C
Storage temperature	T _{stg}	-55~+125	°C

* Reduced by 4.0 mW for each increase in Ta of 1°C over 25°C.

● Recommended operating conditions (Ta = 25°C)

Parameter	Symbol	Min.	Typ.	Max.	Unit
Power supply voltage	V _{cc}	3.0	—	5.5	V

● Block diagram

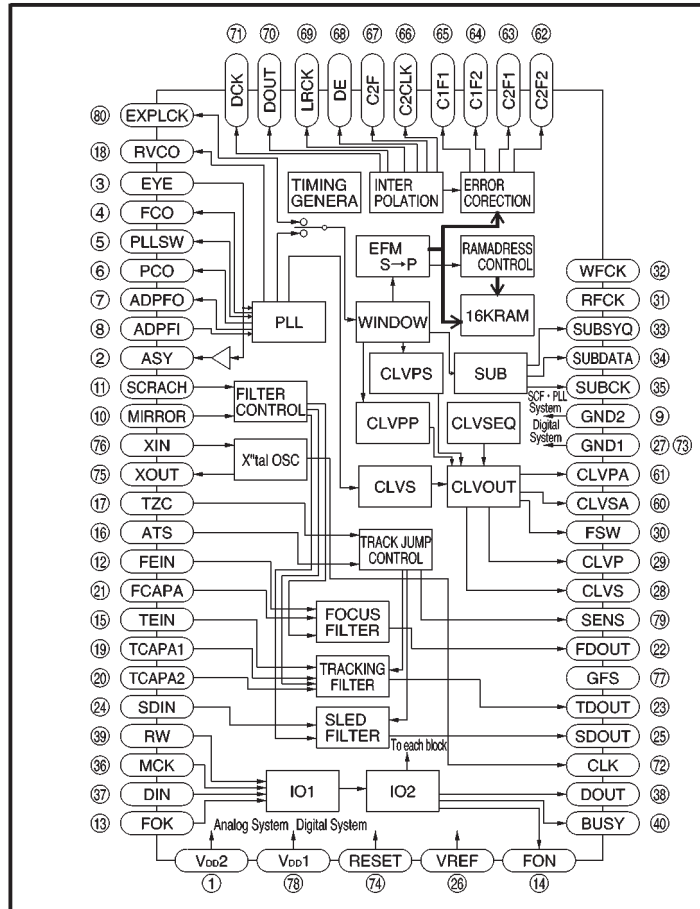

● Pin description

Pin No.	Pin name	Analog / digital	I / O	Function	I / O circuit
1	V _{DD2}	—	—	PLL and servo filter block power supply	—
2	ASY	Digital	O	EFM signal slicing level control output	Fig.5
3	EYE	Digital	I	Input of EFM signals from the RF amplifier	Fig.4
4	FCO	Analog	O	PLL frequency comparison error voltage output	Fig.7
5	PLLSW	Digital	O	PLL time constant switching	Fig.3
6	PCO	Analog	O	PLL phase comparison error voltage output	Fig.7
7	ADPFO	Analog	O	PLL adding amplifier output	Fig.2
8	ADPFI	Analog	I	PLL adding amplifier inverted input	Fig.1
9	GND2	—	—	PLL servo filter block ground	—
10	MIRROR	Digital	I	Mirror signal input	Fig.4
11	SCRACH	Digital	I	Scratch signal input	Fig.4
12	FEIN	Analog	I	Focus error signal input	Fig.1
13	FOK	Digital	I	Focus OK signal input	Fig.4
14	FON	Digital	O	Focus ON signal output	Fig.5
15	TEIN	Analog	I	Tracking error signal input	Fig.1
16	ATS	Analog	I	Anti-shock detection window comparator input	Fig.1
17	TZC	Analog	I	Tracking zero-cross comparator input	Fig.1
18	RVCO	Analog	O	PLL VCO free running resistor	Fig.2
19	TCAPA1	Analog	I / O	Tracking servo filter capacitor connection	Fig.6
20	TCAPA2	Analog	I / O	Tracking servo filter capacitor connection	Fig.6
21	FCAPA	Analog	I / O	Focus servo filter capacitor connection	Fig.6
22	FDOUT	Analog	O	Focus driver output	Fig.2
23	TDOUT	Analog	O	Tracking drive output	Fig.2
24	SDIN	Analog	I	Thread amplifier input	Fig.1
25	SDOUT	Analog	O	Thread driver output	Fig.2
26	VREF	Analog	I	Bias voltage input	Fig.6
27	GND1	—	—	Digital ground	—
28	CLVS	Digital	O	Spindle motor drive output (speed control output)	Fig.7
29	CLVP	Digital	O	Spindle motor drive output (rough or phase control output)	Fig.7
30	FSW	Digital	O	Spindle motor output (filter time constant switching output)	Fig.3
31	RFCK	Digital	O	Read frame clock output (X'tal 7.35 kHz)	Fig.5
32	WFCK	Digital	O	Write frame clock output (7.35 kHz when locked on X'tal)	Fig.5
33	SUBSYQ	Digital	O	Subcode sink S0 + S1 output	Fig.5
34	SUBDATA	Digital	O	Subcode serial output	Fig.5

Pin No.	Pin name	Analog / digital	I / O	Function	I / O circuit
35	SUBCK	Digital	I	Subcode read clock	Fig.4
36	MCK	Digital	I	Clock for CPU serial data reading or sub Q code reading	Fig.4
37	DIN	Digital	I	CPU serial data input	Fig.4
38	DOUT	Digital	O	Sub Q code or internal status serial output	Fig.7
39	RW	Digital	I	Read / write switching or track jump command input (H = data output from DOUT, L = data input from DIN)	Fig.4
40	BUSY	Digital	O	Busy output (L during track jumping)	Fig.5
41~59	N.C.	—	—	—	—
60	CLVPA	Analog	O	CLV phase linear output	Fig.1
61	CLVSA	Analog	O	CLV speed linear output	Fig.1
62	C2F2	Digital	O	C2 double correction flag	Fig.5
63	C2F1	Digital	O	C2 single correction flag	Fig.5
64	C1F2	Digital	O	C1 double correction flag	Fig.5
65	C1F1	Digital	O	C1 single correction flag	Fig.5
66	C2CLK	Digital	O	Strobe signal (f = 176.4 kHz)	Fig.5
67	C2F	Digital	O	Correction status output	Fig.5
68	DE	Digital	O	Strobe signal (f = 88.2 kHz)	Fig.5
69	LRCK	Digital	O	Strobe signal (f = 44.1 kHz)	Fig.5
70	DOUTA	Digital	O	Audio data output (2'SCOMP)	Fig.5
71	DOCK	Digital	O	DOUTA bit clock (f = 2.1168 MHz)	Fig.5
72	CLK	Digital	O	Clock output (4 settings selected with &hE4 command)	Fig.5
73	GND1	—	—	Digital ground	—
74	RESET	Digital	I	Internal circuit reset (pulled up with 100 kΩ internal resistor)	Fig.8
75	XOUT	Digital	O	X'tal oscillator output (f = 16.9 MHz)	Fig.9
76	XIN	Digital	I	X'tal oscillator input (f = 16.9 MHz)	Fig.9
77	GFS	Digital	O	GFS monitor output (4 settings selected with &hE4 command)	Fig.5
78	V _{DD1}	—	—	Digital power supply	—
79	SENS	Digital	O	Status output for signal selected with the &hE4 command	Fig.5
80	EXPLCK	Digital	I / O	PLL output and playback clock input for attached PLL	Fig.10

● Input / output circuits

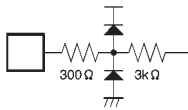

Fig. 1

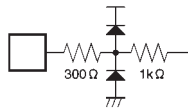

Fig. 2

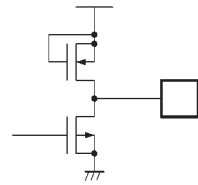

Fig. 3

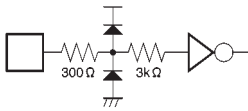

Fig. 4



Fig. 5

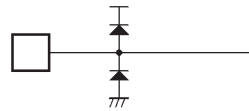

Fig. 6

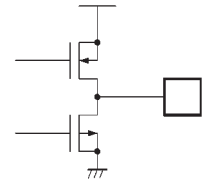

Fig. 7

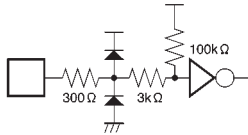

Fig. 8

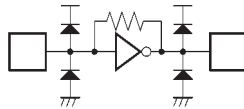

Fig. 9

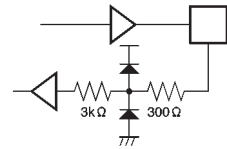

Fig. 10

● Electrical characteristics (unless otherwise noted, Ta = 25°C, VDD = 5V)

Parameter	Symbol	Min.	Typ.	Max.	Unit	Conditions	Suitable pins
Input voltage, high level	V _{IH}	3.5	—	—	V		*1
Input voltage, low level	V _{IL}	—	—	0.3	V		*1
Output voltage, high level	V _{OH}	4.0	—	V _{DD}	V	I _{OH} = -1mA	*2
Output voltage, low level	V _{OL}	0	—	0.4	V	I _{OL} = 1mA	*2, 5
Input resistance 1	V _{O1}	80	100	120	kΩ	Between V _{DD1} pins	*3
Input resistance 2	V _{O2}	60	75	90	kΩ	Between BIAS pins	TZC
Input resistance 3	V _{O3}	180	230	280	kΩ	Between BIAS pins	ATS
Input resistance 4	V _{O4}	20	25	30	kΩ	Between BIAS pins	*6
Input leakage current	I _{LI}	—	—	±5	μA	V _I = 0~5.25V	*1, 2
Output leakage current	I _{LO}	—	—	±5	μA	V _O = 0~5.25V	*4, 5

Suitable pins

*1 MIRROR, SCRACH, FOK, SUBCK, MCK, DIN, RW, RESET, EXPLCK, EYE

*2 FON, CLVS, CLVP, RFCK, WFCK, SUBSYQ, SUBDATA, DOUT, BUSY, XOUT, SENS, GFS, ASY, C1F1, C1F2, C2F1, C2F2, C2CLK, C2F, DE, LRCK, DOCK, CLK

*3 RESET

*4 CLVS, CLVP

*5 PLLSW, TCAPA2, FSW

*6 FEIN, TEIN

● External dimensions (Units: mm)

