

BUD44D2

POWER TRANSISTORS
2 AMPERES
700 VOLTS
25 WATTS

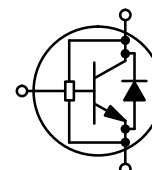

Advance Information

High Speed, High Gain Bipolar NPN Power Transistor with Integrated Collector-Emitter Diode and Built-in Efficient Antisaturation Network

The BUD44D2 is state-of-art High Speed High gain BIPolar transistor (H2BIP). High dynamic characteristics and lot to lot minimum spread (± 150 ns on storage time) make it ideally suitable for light ballast applications. Therefore, there is no need to guarantee an h_{FE} window.

Main features:

- Low Base Drive Requirement
- High Peak DC Current Gain (55 Typical) @ $I_C = 100$ mA
- **Extremely Low Storage Time Min/Max Guarantees Due to the H2BIP Structure which Minimizes the Spread**
- Integrated Collector-Emitter Free Wheeling Diode
- Fully Characterized and Guaranteed Dynamic $V_{CE(sat)}$
- "6 Sigma" Process Providing Tight and Reproducible Parameter Spreads

It's characteristics make it also suitable for PFC application.

MAXIMUM RATINGS

Rating	Symbol	Value	Unit
Collector-Emitter Sustaining Voltage	V_{CEO}	400	Vdc
Collector-Base Breakdown Voltage	V_{CBO}	700	Vdc
Collector-Emitter Breakdown Voltage	V_{CES}	700	Vdc
Emitter-Base Voltage	V_{EBO}	12	Vdc
Collector Current — Continuous	I_C	2	Adc
— Peak (1)	I_{CM}	5	
Base Current — Continuous	I_B	1	Adc
— Peak (1)	I_{BM}	2	
*Total Device Dissipation @ $T_C = 25^\circ\text{C}$ *Derate above 25°C	P_D	25 0.2	Watt W/ $^\circ\text{C}$
Operating and Storage Temperature	T_J, T_{stg}	-65 to 150	$^\circ\text{C}$

THERMAL CHARACTERISTICS

Thermal Resistance — Junction to Case — Junction to Ambient	$R_{\theta JC}$ $R_{\theta JA}$	5 71.4	$^\circ\text{C}/\text{W}$
Maximum Lead Temperature for Soldering Purposes: 1/8" from case for 5 seconds	T_L	260	$^\circ\text{C}$

(1) Pulse Test: Pulse Width = 5 ms, Duty Cycle $\leq 10\%$.

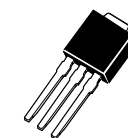

CASE 369-07



CASE 369A-13

**MINIMUM PAD SIZES
RECOMMENDED FOR
SURFACE MOUNTED
APPLICATIONS**

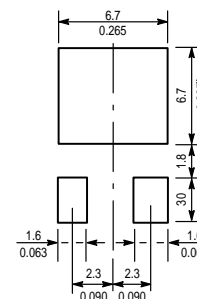

Designer's and SWITCHMODE are trademarks of Motorola, Inc.

This document contains information on a new product. Specifications and information herein are subject to change without notice.

BUD44D2

ELECTRICAL CHARACTERISTICS ($T_C = 25^\circ\text{C}$ unless otherwise noted)

Characteristic	Symbol	Min	Typ	Max	Unit
OFF CHARACTERISTICS					
Collector–Emitter Sustaining Voltage ($I_C = 100\text{ mA}$, $L = 25\text{ mH}$)	$V_{CEQ(sus)}$	400	470		Vdc
Collector–Base Breakdown Voltage ($I_{CBO} = 1\text{ mA}$)	V_{CBO}	700	920		Vdc
Emitter–Base Breakdown Voltage ($I_{EBO} = 1\text{ mA}$)	V_{EBO}	12	14.5		Vdc
Collector Cutoff Current ($V_{CE} = \text{Rated } V_{CEO}$, $I_B = 0$)	@ $T_C = 25^\circ\text{C}$ @ $T_C = 125^\circ\text{C}$ I_{CEO}			50 500	μAdc
Collector Cutoff Current ($V_{CE} = \text{Rated } V_{CES}$, $V_{EB} = 0$) ($V_{CE} = 500\text{ V}$, $V_{EB} = 0$)	@ $T_C = 25^\circ\text{C}$ @ $T_C = 125^\circ\text{C}$ @ $T_C = 125^\circ\text{C}$ I_{CES}			50 500 100	μAdc
Emitter–Cutoff Current ($V_{EB} = 10\text{ Vdc}$, $I_C = 0$)	I_{EBO}			100	μAdc

ON CHARACTERISTICS

Base–Emitter Saturation Voltage ($I_C = 0.4\text{ Adc}$, $I_B = 40\text{ mAdc}$) ($I_C = 1\text{ Adc}$, $I_B = 0.2\text{ Adc}$)	@ $T_C = 25^\circ\text{C}$ @ $T_C = 125^\circ\text{C}$ $V_{BE(sat)}$		0.78 0.65	0.9 0.8	Vdc
	@ $T_C = 25^\circ\text{C}$ @ $T_C = 125^\circ\text{C}$		0.87 0.76	1 0.9	
Collector–Emitter Saturation Voltage ($I_C = 0.4\text{ Adc}$, $I_B = 20\text{ mAdc}$) ($I_C = 0.4\text{ Adc}$, $I_B = 40\text{ mAdc}$) ($I_C = 1\text{ Adc}$, $I_B = 0.2\text{ Adc}$)	@ $T_C = 25^\circ\text{C}$ @ $T_C = 125^\circ\text{C}$ $V_{CE(sat)}$		0.45 0.67	0.65 1	Vdc
	@ $T_C = 25^\circ\text{C}$ @ $T_C = 125^\circ\text{C}$		0.25 0.27	0.4 0.5	
	@ $T_C = 25^\circ\text{C}$ @ $T_C = 125^\circ\text{C}$		0.28 0.35	0.5 0.6	
DC Current Gain ($I_C = 0.4\text{ Adc}$, $V_{CE} = 1\text{ Vdc}$) ($I_C = 1\text{ Adc}$, $V_{CE} = 1\text{ Vdc}$) ($I_C = 2\text{ Adc}$, $V_{CE} = 5\text{ Vdc}$)	@ $T_C = 25^\circ\text{C}$ @ $T_C = 125^\circ\text{C}$ h_{FE}	20 18	32 26		—
	@ $T_C = 25^\circ\text{C}$ @ $T_C = 125^\circ\text{C}$	10 7	14 9.5		
	@ $T_C = 25^\circ\text{C}$	8	11		

DIODE CHARACTERISTICS

Forward Diode Voltage ($I_{EC} = 0.2\text{ Adc}$) ($I_{EC} = 0.2\text{ Adc}$) ($I_{EC} = 0.4\text{ Adc}$) ($I_{EC} = 1\text{ Adc}$)	@ $T_C = 25^\circ\text{C}$ V_{EC}		0.8	1	V
	@ $T_C = 125^\circ\text{C}$		0.6		
	@ $T_C = 25^\circ\text{C}$		0.9	1.2	
	@ $T_C = 25^\circ\text{C}$		1.1	1.5	
Forward Recovery Time (see Figure 22 bis) ($I_F = 0.2\text{ Adc}$, $di/dt = 10\text{ A}/\mu\text{s}$) ($I_F = 0.4\text{ Adc}$, $di/dt = 10\text{ A}/\mu\text{s}$) ($I_F = 1\text{ Adc}$, $di/dt = 10\text{ A}/\mu\text{s}$)	@ $T_C = 25^\circ\text{C}$ T_{fr}		415		ns
	@ $T_C = 25^\circ\text{C}$		390		
	@ $T_C = 25^\circ\text{C}$		340		

ELECTRICAL CHARACTERISTICS ($T_C = 25^\circ\text{C}$ unless otherwise noted)

Characteristic			Symbol	Min	Typ	Max	Unit
DYNAMIC SATURATION VOLTAGE							
Dynamic Saturation Voltage: Determined 1 μs and 3 μs respectively after rising I_{B1} reaches 90% of final I_{B1}	$I_C = 0.4\text{ A}$ $I_{B1} = 40\text{ mA}$ $V_{CC} = 300\text{ V}$	@ 1 μs	@ $T_C = 25^\circ\text{C}$ @ $T_C = 125^\circ\text{C}$	$V_{CE(dsat)}$		3.3 6.8	V
		@ 3 μs	@ $T_C = 25^\circ\text{C}$ @ $T_C = 125^\circ\text{C}$			0.5 1.3	
	$I_C = 1\text{ A}$ $I_{B1} = 0.2\text{ A}$ $V_{CC} = 300\text{ V}$	@ 1 μs	@ $T_C = 25^\circ\text{C}$ @ $T_C = 125^\circ\text{C}$			4.4 12.8	
		@ 3 μs	@ $T_C = 25^\circ\text{C}$ @ $T_C = 125^\circ\text{C}$			0.5 1.8	

DYNAMIC CHARACTERISTICS

Current Gain Bandwidth ($I_C = 0.5\text{ Adc}$, $V_{CE} = 10\text{ Vdc}$, $f = 1\text{ MHz}$)	f_T		13		MHz
Output Capacitance ($V_{CB} = 10\text{ Vdc}$, $I_E = 0$, $f = 1\text{ MHz}$)	C_{ob}		50	75	pF
Input Capacitance ($V_{EB} = 8\text{ Vdc}$)	C_{ib}		240	500	pF

SWITCHING CHARACTERISTICS: Resistive Load (D.C. $\leq 10\%$, Pulse Width = 40 μs)

Turn-on Time	$I_C = 1\text{ Adc}$, $I_{B1} = 0.2\text{ Adc}$ $I_{B2} = 0.5\text{ Adc}$ $V_{CC} = 300\text{ Vdc}$	@ $T_C = 25^\circ\text{C}$ @ $T_C = 125^\circ\text{C}$	t_{on}		90 105	150	ns
Turn-off Time		@ $T_C = 25^\circ\text{C}$ @ $T_C = 125^\circ\text{C}$	t_{off}		1.1 1.5	1.25	μs
Turn-on Time	$I_C = 0.5\text{ Adc}$, $I_{B1} = 50\text{ mAdc}$ $I_{B2} = 250\text{ mAdc}$ $V_{CC} = 300\text{ Vdc}$	@ $T_C = 25^\circ\text{C}$ @ $T_C = 125^\circ\text{C}$	t_{on}	400	600	600	ns
Turn-off Time		@ $T_C = 25^\circ\text{C}$ @ $T_C = 125^\circ\text{C}$	t_{off}	750	1300	1000	ns

SWITCHING CHARACTERISTICS: Inductive Load ($V_{clamp} = 300\text{ V}$, $V_{CC} = 15\text{ V}$, $L = 200\text{ }\mu\text{H}$)

Fall Time	$I_C = 0.4\text{ Adc}$ $I_{B1} = 40\text{ mAdc}$ $I_{B2} = 0.2\text{ Adc}$	@ $T_C = 25^\circ\text{C}$ @ $T_C = 125^\circ\text{C}$	t_f		110 105	150	ns
Storage Time		@ $T_C = 25^\circ\text{C}$ @ $T_C = 125^\circ\text{C}$	t_s		0.55 0.7	0.75	μs
Crossover Time		@ $T_C = 25^\circ\text{C}$ @ $T_C = 125^\circ\text{C}$	t_c		85 80	150	ns
Fall Time	$I_C = 1\text{ Adc}$ $I_{B1} = 0.2\text{ Adc}$ $I_{B2} = 0.5\text{ Adc}$	@ $T_C = 25^\circ\text{C}$ @ $T_C = 125^\circ\text{C}$	t_f		100 90	150	ns
Storage Time		@ $T_C = 25^\circ\text{C}$ @ $T_C = 125^\circ\text{C}$	t_s		1.05 1.45	1.5	μs
Crossover Time		@ $T_C = 25^\circ\text{C}$ @ $T_C = 125^\circ\text{C}$	t_c		100 100	175	ns
Fall Time	$I_C = 0.8\text{ Adc}$ $I_{B1} = 160\text{ mAdc}$ $I_{B2} = 160\text{ mAdc}$	@ $T_C = 25^\circ\text{C}$ @ $T_C = 125^\circ\text{C}$	t_f		110 180	150	ns
Storage Time		@ $T_C = 25^\circ\text{C}$ @ $T_C = 125^\circ\text{C}$	t_s	2.05	2.8	2.35	μs
Crossover Time		@ $T_C = 25^\circ\text{C}$ @ $T_C = 125^\circ\text{C}$	t_c		180 400	300	ns
Fall Time	$I_C = 0.4\text{ Adc}$ $I_{B1} = 40\text{ mAdc}$ $I_{B2} = 40\text{ mAdc}$	@ $T_C = 25^\circ\text{C}$ @ $T_C = 125^\circ\text{C}$	t_f		150 175	225	ns
Storage Time		@ $T_C = 25^\circ\text{C}$ @ $T_C = 125^\circ\text{C}$	t_s	1.65	2.2	1.95	μs
Crossover Time		@ $T_C = 25^\circ\text{C}$ @ $T_C = 125^\circ\text{C}$	t_c		150 330	250	ns

TYPICAL STATIC CHARACTERISTICS

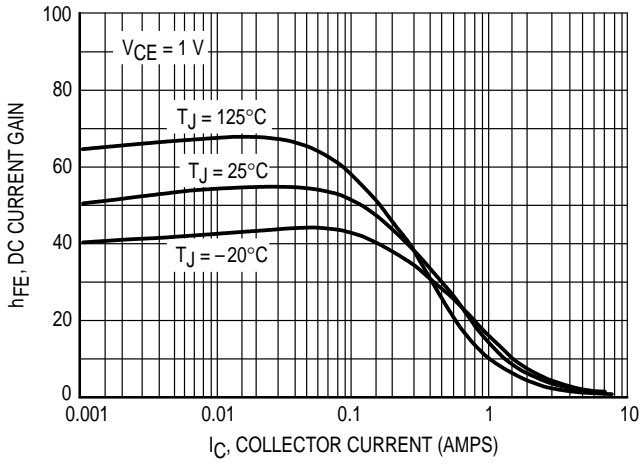

Figure 1. DC Current Gain @ 1 Volt

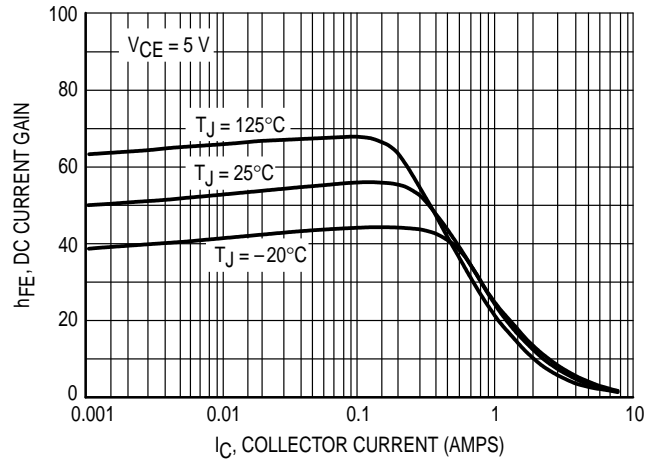

Figure 2. DC Current Gain @ 5 Volt

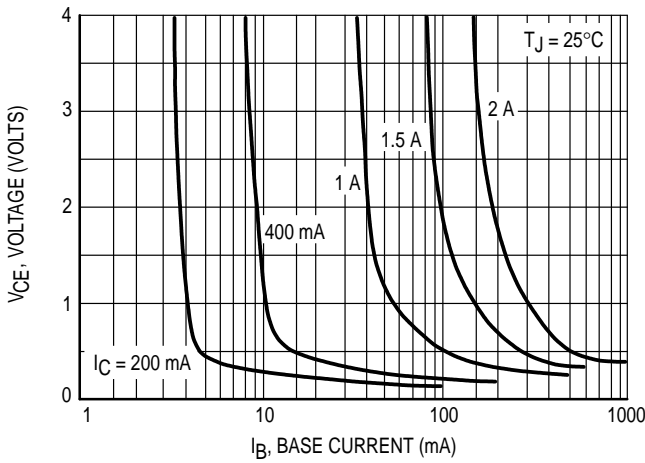

Figure 3. Collector Saturation Region

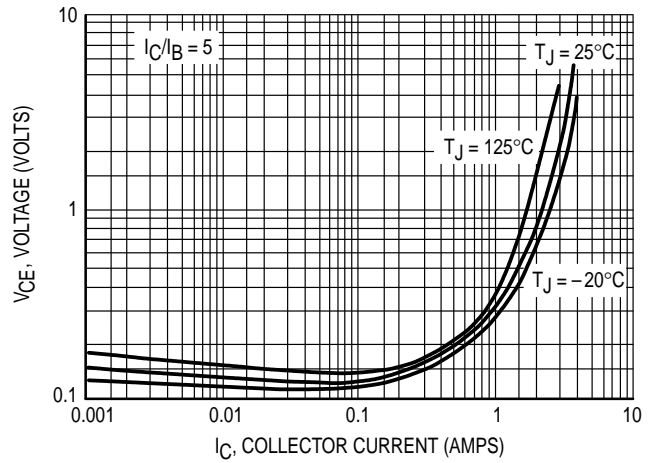

Figure 4. Collector-Emitter Saturation Voltage

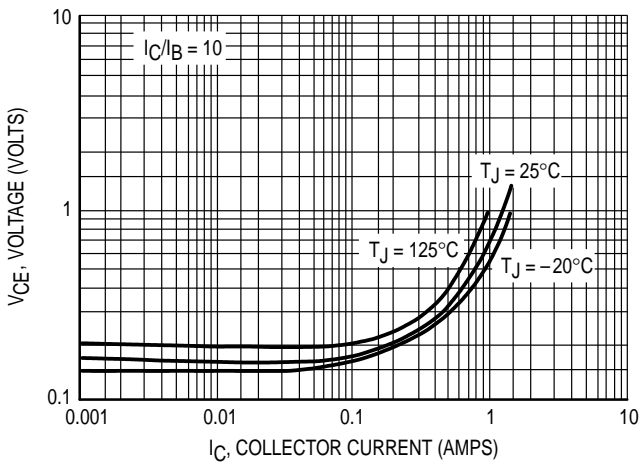

Figure 5. Collector-Emitter Saturation Voltage

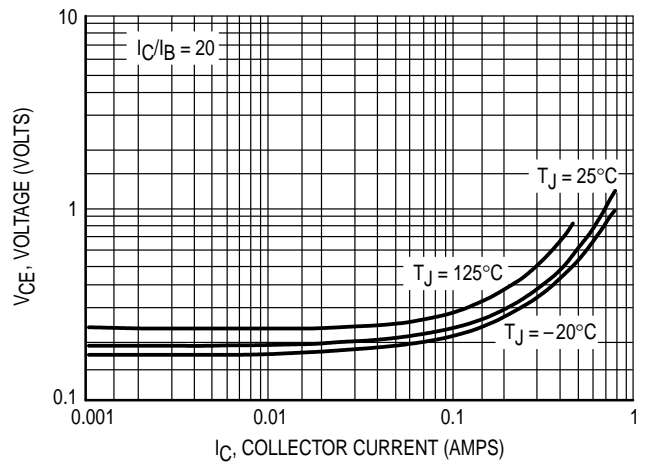

Figure 6. Collector-Emitter Saturation Voltage

TYPICAL STATIC CHARACTERISTICS

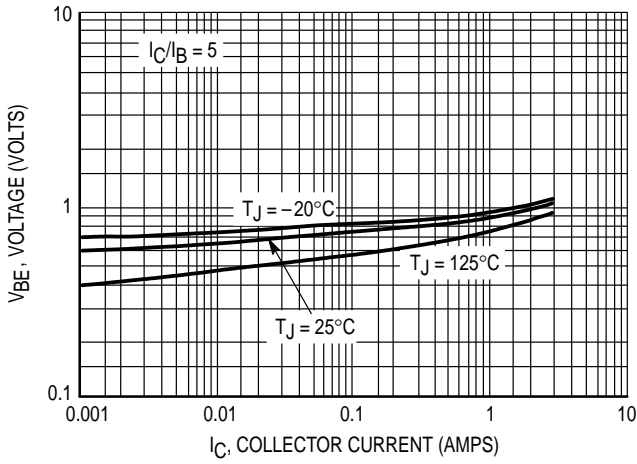

Figure 7A. Base-Emitter Saturation Region

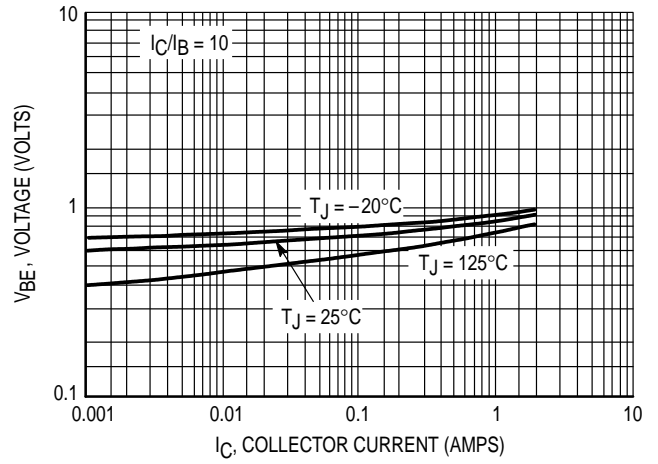

Figure 7B. Base-Emitter Saturation Region

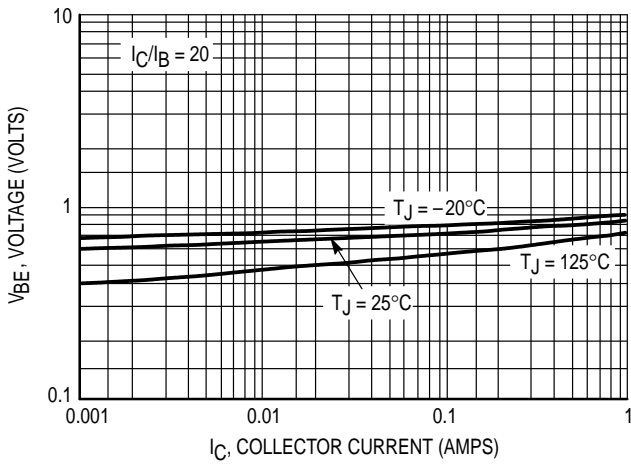

Figure 7C. Base-Emitter Saturation Region

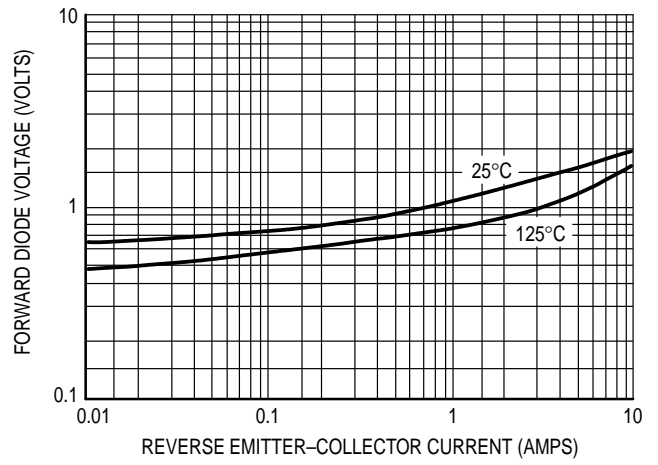

Figure 8. Forward Diode Voltage

TYPICAL SWITCHING CHARACTERISTICS

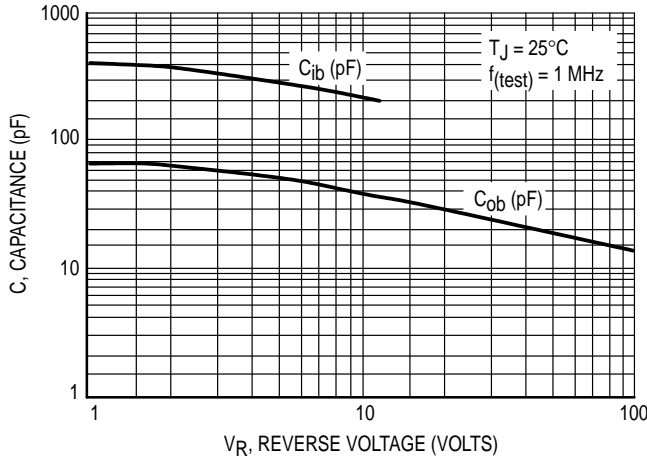

Figure 9. Capacitance

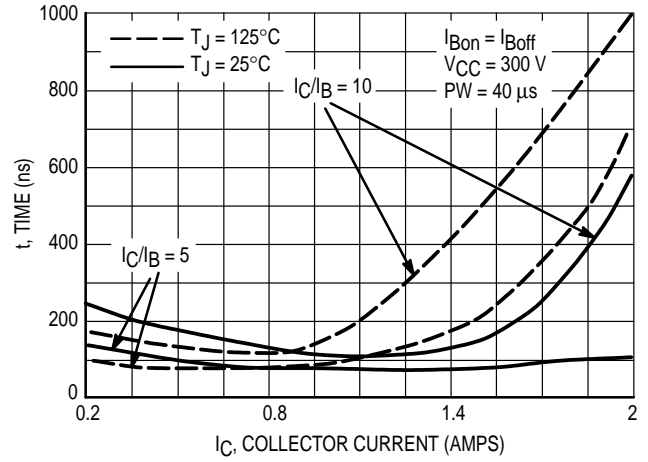

Figure 10. Resistive Switch Time, t_{on}

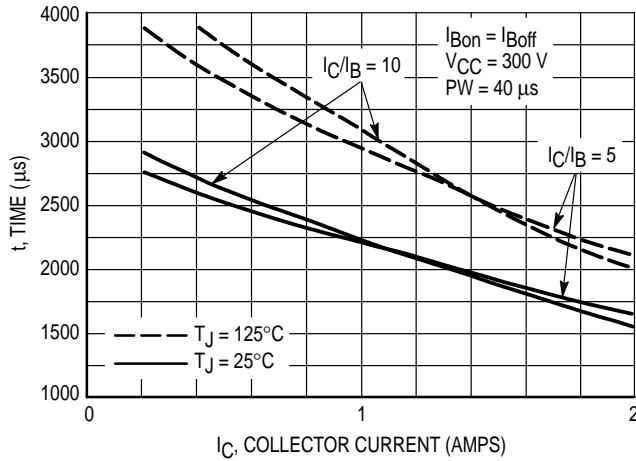

Figure 11. Resistive Switch Time, t_{off}

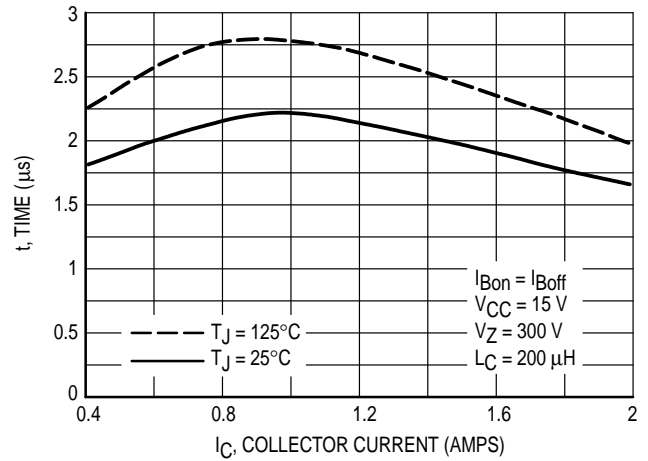

Figure 12. Inductive Storage Time, t_{si} @ I_C/I_B = 5

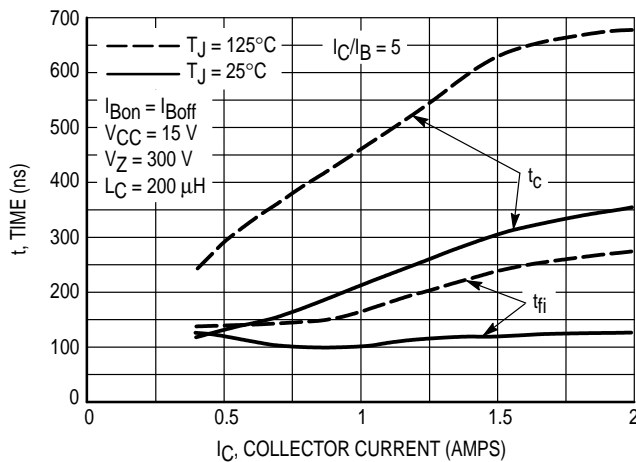

Figure 13. Inductive Switching, t_c & t_{fi} @ I_C/I_B = 5

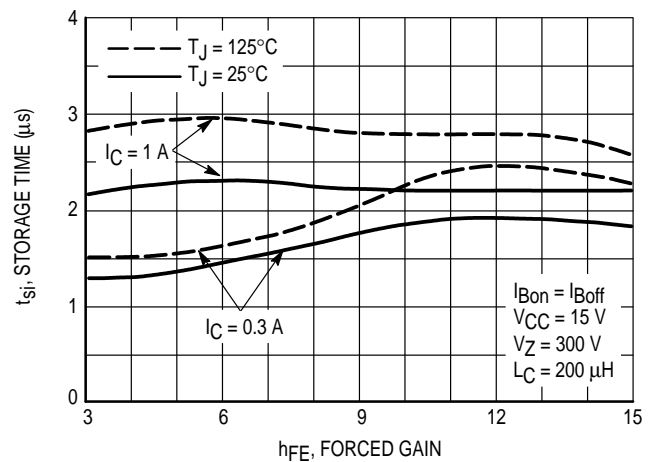

Figure 14. Inductive Storage Time

TYPICAL SWITCHING CHARACTERISTICS

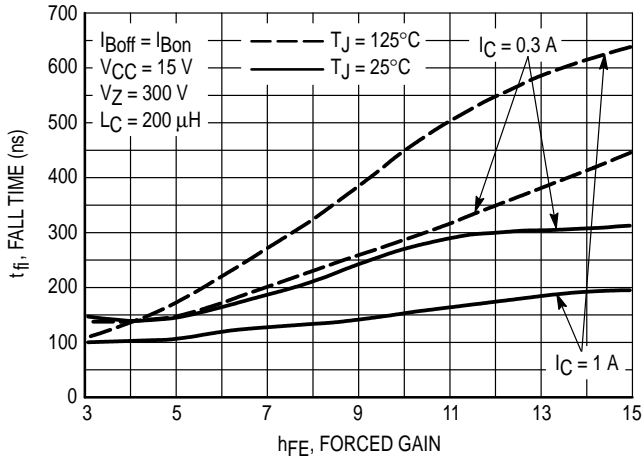

Figure 15. Inductive Fall Time

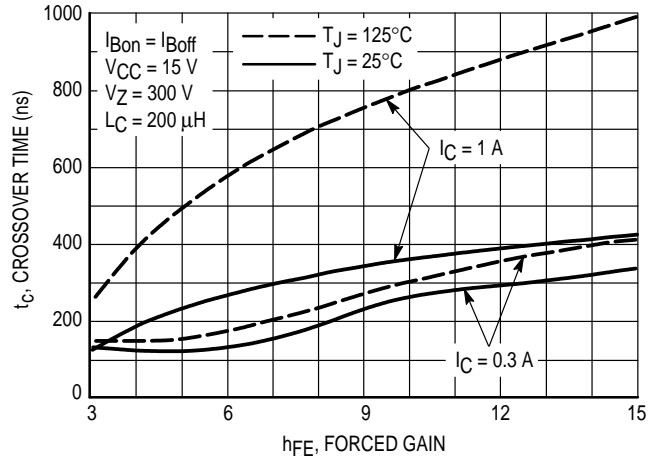

Figure 16. Inductive Crossover Time

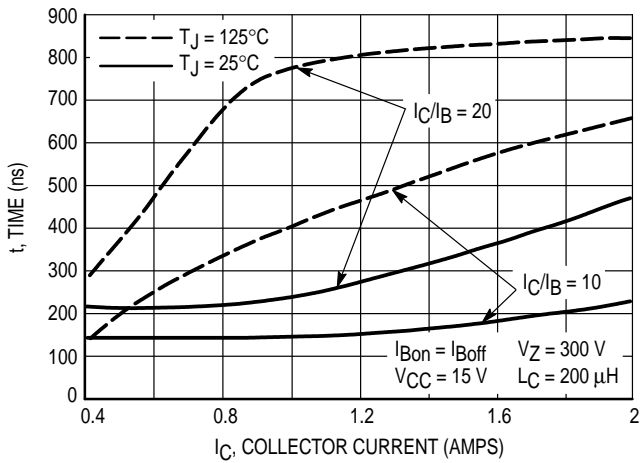

Figure 17. Inductive Switching, t_{fi}

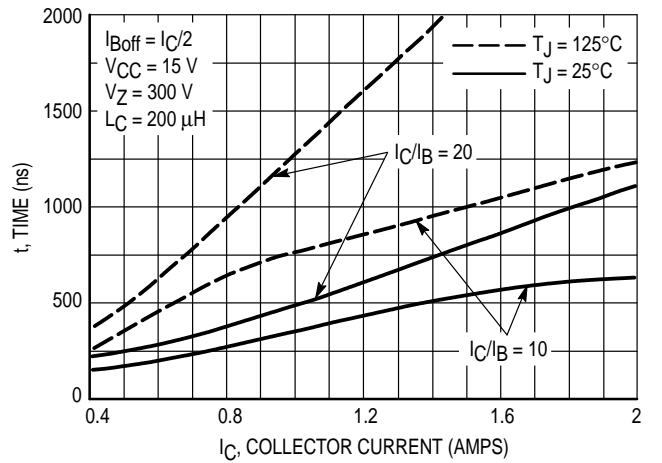

Figure 18. Inductive Switching, t_c

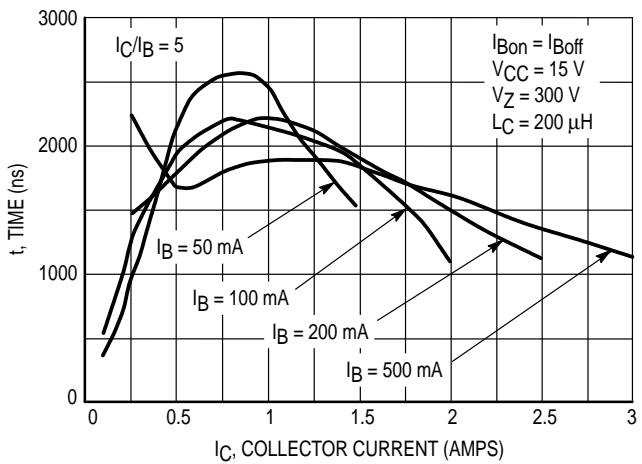

Figure 19. Inductive Storage Time, t_{sj}

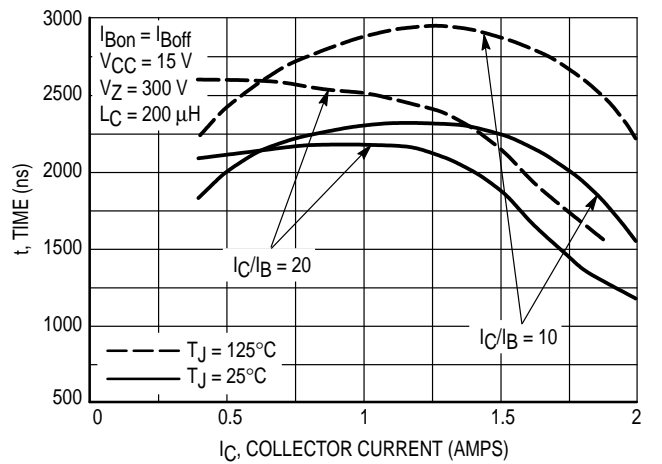

Figure 20. Inductive Storage Time, t_{sj}

TYPICAL SWITCHING CHARACTERISTICS

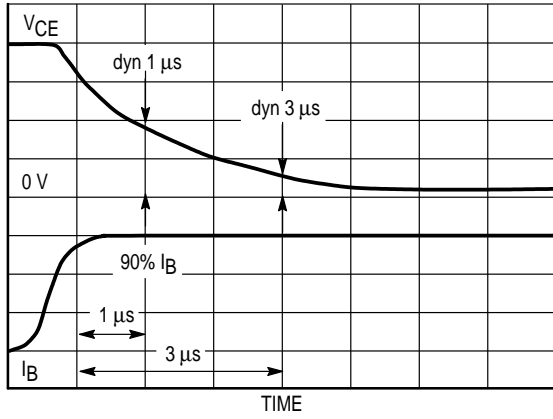

Figure 21. Dynamic Saturation Voltage Measurements

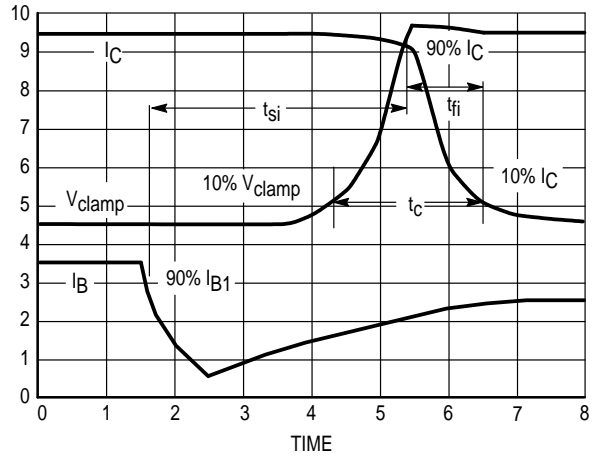

Figure 22. Inductive Switching Measurements

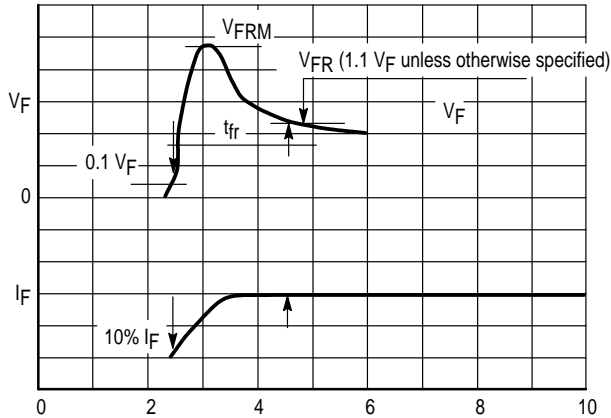
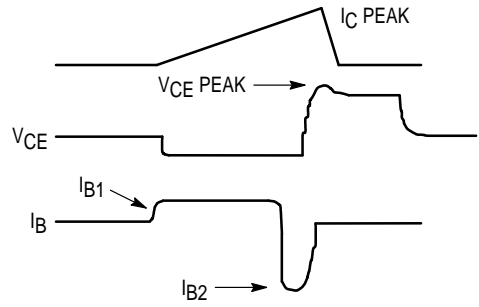
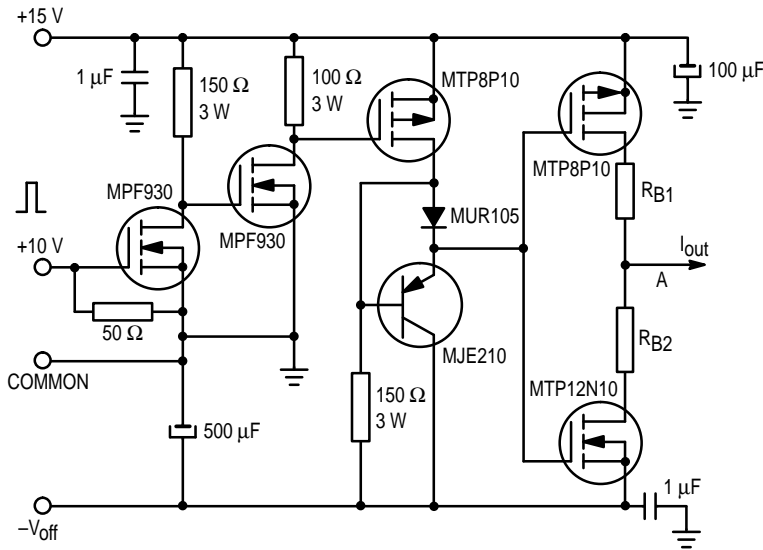

Figure 22 bis. t_{fr} Measurements

TYPICAL SWITCHING CHARACTERISTICS

Table 1. Inductive Load Switching Drive Circuit



$V_{(BR)CEO}(sus)$	Inductive Switching	RBSOA
$L = 10\text{ mH}$	$L = 200\text{ }\mu\text{H}$	$L = 500\text{ }\mu\text{H}$
$R_{B2} = \infty$	$R_{B2} = 0$	$R_{B2} = 0$
$V_{CC} = 20\text{ Volts}$	$V_{CC} = 15\text{ Volts}$	$V_{CC} = 15\text{ Volts}$
$I_{C(pk)} = 100\text{ mA}$	R_{B1} selected for desired I_{B1}	R_{B1} selected for desired I_{B1}

TYPICAL STATIC CHARACTERISTICS

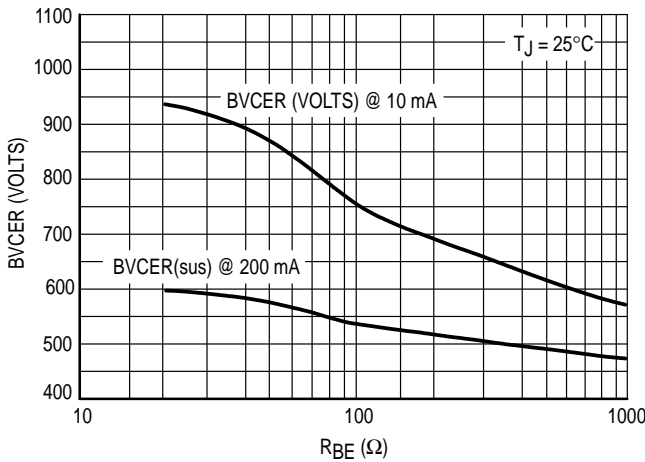

Figure 23. BVCEr

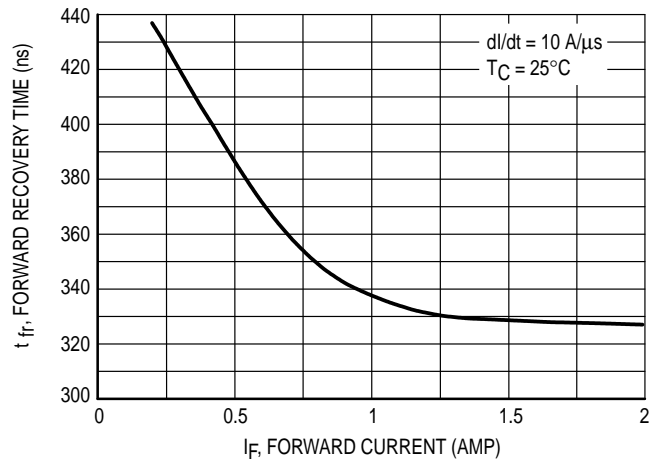
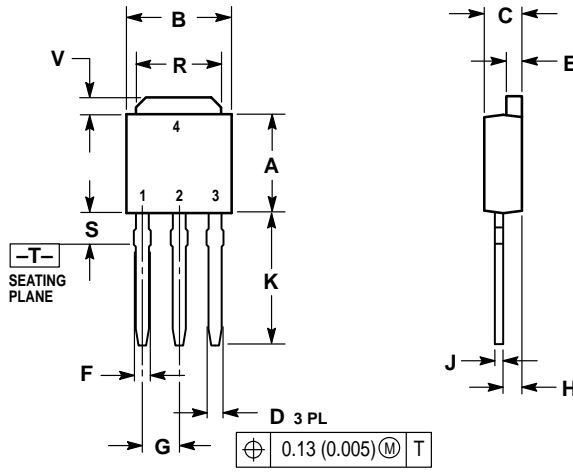

Figure 24. Forward Recovery Time t_{fr}

Motorola reserves the right to make changes without further notice to any products herein. Motorola makes no warranty, representation or guarantee regarding the suitability of its products for any particular purpose, nor does Motorola assume any liability arising out of the application or use of any product or circuit, and specifically disclaims any and all liability, including without limitation consequential or incidental damages. "Typical" parameters can and do vary in different applications. All operating parameters, including "Typicals" must be validated for each customer application by customer's technical experts. Motorola does not convey any license under its patent rights nor the rights of others. Motorola products are not designed, intended, or authorized for use as components in systems intended for surgical implant into the body, or other applications intended to support or sustain life, or for any other application in which the failure of the Motorola product could create a situation where personal injury or death may occur. Should Buyer purchase or use Motorola products for any such unintended or unauthorized application, Buyer shall indemnify and hold Motorola and its officers, employees, subsidiaries, affiliates, and distributors harmless against all claims, costs, damages, and expenses, and reasonable attorney fees arising out of, directly or indirectly, any claim of personal injury or death associated with such unintended or unauthorized use, even if such claim alleges that Motorola was negligent regarding the design or manufacture of the part. Motorola and are registered trademarks of Motorola, Inc. Motorola, Inc. is an Equal Opportunity/Affirmative Action Employer.

PACKAGE DIMENSIONS



- NOTES:
 1. DIMENSIONING AND TOLERANCING PER ANSI Y14.5M, 1982.
 2. CONTROLLING DIMENSION: INCH.

DIM	INCHES		MILLIMETERS	
	MIN	MAX	MIN	MAX
A	0.235	0.250	5.97	6.35
B	0.250	0.265	6.35	6.73
C	0.086	0.094	2.19	2.38
D	0.027	0.035	0.69	0.88
E	0.033	0.040	0.84	1.01
F	0.037	0.047	0.94	1.19
G	0.090 BSC		2.29 BSC	
H	0.034	0.040	0.87	1.01
J	0.018	0.023	0.46	0.58
K	0.350	0.380	8.89	9.65
R	0.175	0.215	4.45	5.46
S	0.050	0.090	1.27	2.28
V	0.030	0.050	0.77	1.27

- STYLE 1:
 PIN 1. BASE
 2. COLLECTOR
 3. EMITTER
 4. COLLECTOR

CASE 369-07
 ISSUE K

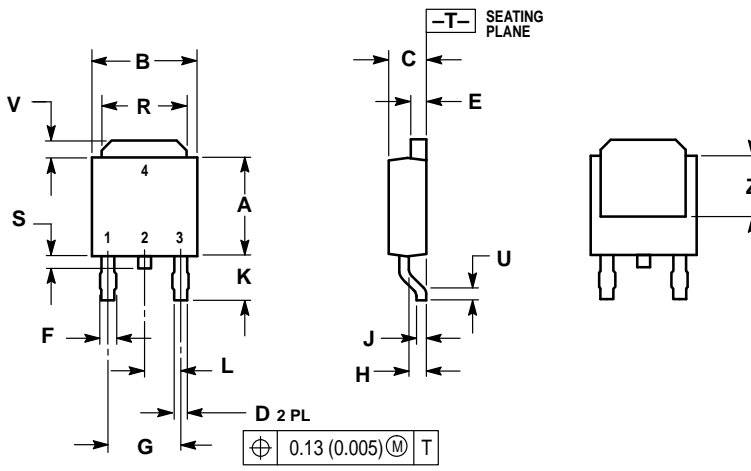

- NOTES:
 1. DIMENSIONING AND TOLERANCING PER ANSI Y14.5M, 1982.
 2. CONTROLLING DIMENSION: INCH.

DIM	INCHES		MILLIMETERS	
	MIN	MAX	MIN	MAX
A	0.235	0.250	5.97	6.35
B	0.250	0.265	6.35	6.73
C	0.086	0.094	2.19	2.38
D	0.027	0.035	0.69	0.88
E	0.033	0.040	0.84	1.01
F	0.037	0.047	0.94	1.19
G	0.180 BSC		4.58 BSC	
H	0.034	0.040	0.87	1.01
J	0.018	0.023	0.46	0.58
K	0.102	0.114	2.60	2.89
L	0.090 BSC		2.29 BSC	
R	0.175	0.215	4.45	5.46
S	0.020	0.050	0.51	1.27
U	0.020	—	0.51	—
V	0.030	0.050	0.77	1.27
Z	0.138	—	3.51	—

- STYLE 1:
 PIN 1. BASE
 2. COLLECTOR
 3. EMITTER
 4. COLLECTOR

CASE 369A-13
 ISSUE W

How to reach us:
 USA / EUROPE: Motorola Literature Distribution;
 P.O. Box 20912; Phoenix, Arizona 85036. 1-800-441-2447

JAPAN: Nippon Motorola Ltd.; Tatsumi-SPD-JLDC, Toshikatsu Otsuki,
 6F Seibu-Butsuryu-Center, 3-14-2 Tatsumi Koto-Ku, Tokyo 135, Japan. 03-3521-8315

MFAX: RMFAX0@email.sps.mot.com - TOUCHTONE (602) 244-6609
 INTERNET: http://Design-NET.com

HONG KONG: Motorola Semiconductors H.K. Ltd.; 8B Tai Ping Industrial Park,
 51 Ting Kok Road, Tai Po, N.T., Hong Kong. 852-26629298

