



BUJ302A

NPN power transistor

Rev. 02 — 28 March 2011

Product data sheet

1. Product profile

1.1 General description

High-voltage, high-speed planar-passivated NPN power switching transistor in a SOT78 (TO-220AB) plastic package.

1.2 Features and benefits

- Fast switching
- High voltage capability
- Low thermal resistance

1.3 Applications

- DC-to-DC converters
- High-frequency electronic lighting ballast applications
- Inverters
- Motor control systems

1.4 Quick reference data

Table 1. Quick reference data

Symbol	Parameter	Conditions	Min	Typ	Max	Unit
I_C	collector current	see Figure 1 ; see Figure 2 ; see Figure 4	-	-	4	A
P_{tot}	total power dissipation	$T_{mb} \leq 25\text{ °C}$; see Figure 3	-	-	80	W
V_{CESM}	collector-emitter peak voltage	$V_{BE} = 0\text{ V}$	-	-	1050	V
Static characteristics						
h_{FE}	DC current gain	$I_C = 0.1\text{ A}$; $V_{CE} = 5\text{ V}$; $T_{mb} = 25\text{ °C}$; see Figure 11	[1] 48	66	100	
		$I_C = 0.8\text{ A}$; $V_{CE} = 3\text{ V}$; $T_{mb} = 25\text{ °C}$; see Figure 12	[1] 25	42	50	

[1] Pulse test: pulse duration $\leq 300\text{ }\mu\text{s}$, duty cycle $\leq 2\%$



2. Pinning information

Table 2. Pinning information

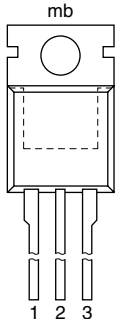
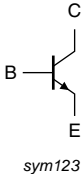
Pin	Symbol	Description	Simplified outline	Graphic symbol
1	B	base		
2	C	collector		
3	E	emitter		
mb	C	mounting base; connected to collector		

SOT78 (TO-220AB)

3. Ordering information

Table 3. Ordering information

Type number	Package		
	Name	Description	Version
BUJ302A	TO-220AB	plastic single-ended package; heatsink mounted; 1 mounting hole; 3-lead TO-220AB	SOT78

4. Limiting values

Table 4. Limiting values

In accordance with the Absolute Maximum Rating System (IEC 60134).

Symbol	Parameter	Conditions	Min	Max	Unit
V_{CESM}	collector-emitter peak voltage	$V_{BE} = 0\text{ V}$	-	1050	V
V_{CEO}	collector-emitter voltage	$I_B = 0\text{ A}$	-	400	V
I_C	collector current	see Figure 1 ; see Figure 2 ; see Figure 4	-	4	A
I_{CM}	peak collector current		-	8	A
I_B	base current		-	2	A
I_{BM}	peak base current		-	4	A
P_{tot}	total power dissipation	$T_{mb} \leq 25\text{ °C}$; see Figure 3	-	80	W
T_{stg}	storage temperature		-65	150	°C
T_j	junction temperature		-	150	°C
V_{EBO}	emitter-base voltage	$I_C = 0\text{ A}$; $I_E = 2\text{ A}$; $t_p < 10\text{ ms}$	-	24	V

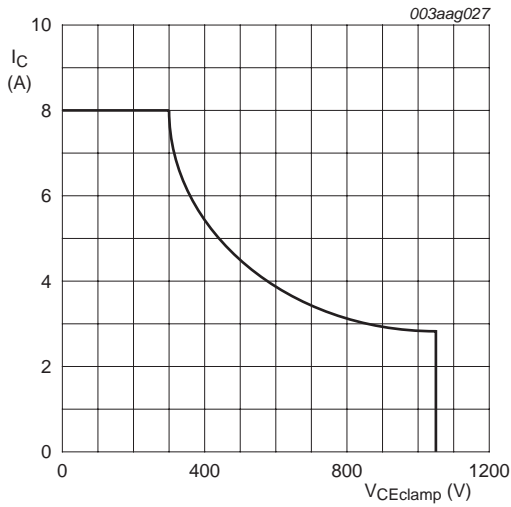

$$T_j \leq T_{j(max)} \text{ } ^\circ\text{C}$$

Fig 1. Reverse bias safe operating area

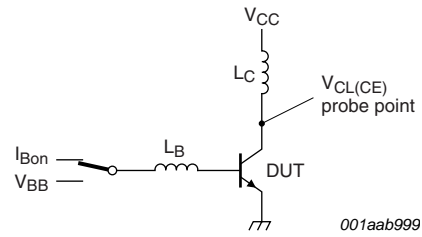

$$V_{CL(CE)} \leq 1000 \text{ V}; V_{CC} = 150 \text{ V}; V_{BB} = -5 \text{ V};$$

$$L_B = 1 \mu\text{H}; L_C = 200 \mu\text{H}$$

Fig 2. Test circuit for reverse bias safe operating area

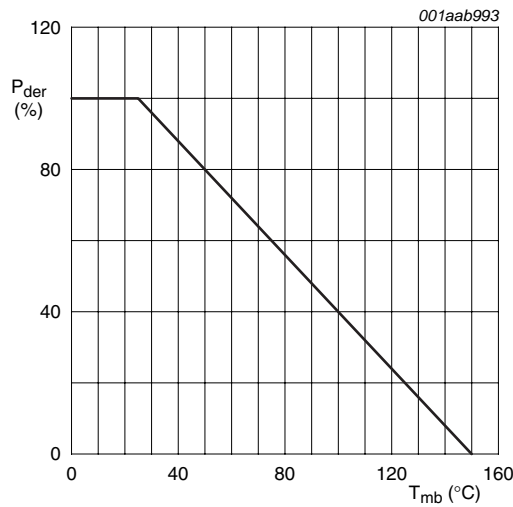

$$P_{der} = \frac{P_{tot}}{P_{tot(25^\circ\text{C})}} \times 100 \%$$

Fig 3. Normalized total power dissipation as a function of mounting base temperature

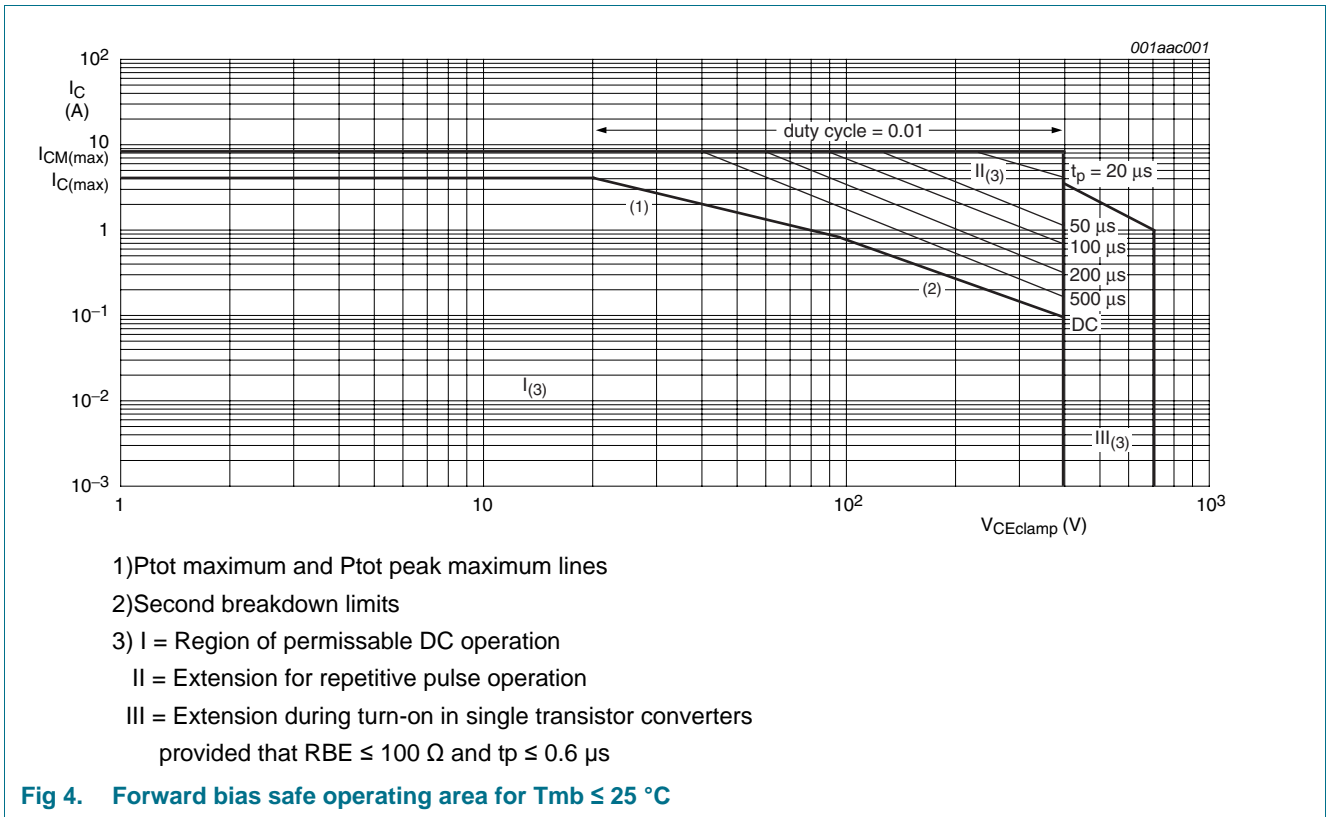

5. Thermal characteristics

Table 5. Thermal characteristics

Symbol	Parameter	Conditions	Min	Typ	Max	Unit
$R_{th(j-mb)}$	thermal resistance from junction to mounting base	see Figure 5	-	-	1.56	K/W
$R_{th(j-a)}$	thermal resistance from junction to ambient	in free air	-	60	-	K/W

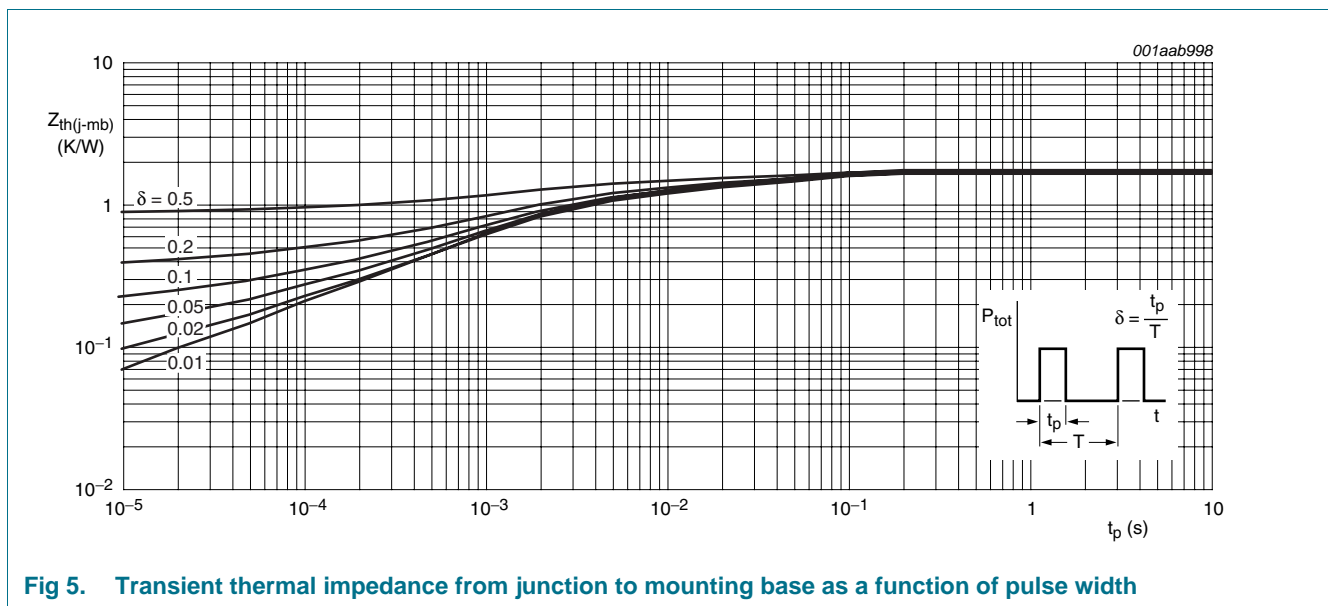

Fig 5. Transient thermal impedance from junction to mounting base as a function of pulse width

6. Characteristics

Table 6. Characteristics

Symbol	Parameter	Conditions	Min	Typ	Max	Unit	
Static characteristics							
I_{CES}	collector-emitter cut-off current	$V_{BE} = 0\text{ V}; V_{CE} = 1050\text{ V}; T_{mb} = 25\text{ }^\circ\text{C}$	-	0.2	10	μA	
I_{CEO}	collector-emitter cut-off current	$V_{CE} = 400\text{ V}; I_B = 0\text{ A}; T_{mb} = 25\text{ }^\circ\text{C}$	-	10	250	mA	
$V_{(BR)EBO}$	open-collector emitter-base breakdown voltage	$I_B = 1\text{ mA}; I_C = 0\text{ A}; T_{mb} = 25\text{ }^\circ\text{C}$	15	19	-	V	
V_{CEOsus}	collector-emitter sustaining voltage	$I_B = 0\text{ A}; I_C = 10\text{ mA}; L_C = 25\text{ mH}; T_{mb} = 25\text{ }^\circ\text{C};$ see Figure 6 ; see Figure 7	[1]	400	470	-	V
V_{CEsat}	collector-emitter saturation voltage	$I_C = 1\text{ A}; I_B = 0.2\text{ A}; T_{mb} = 25\text{ }^\circ\text{C};$ see Figure 8 ; see Figure 9	[1]	-	0.15	0.5	V
		$I_C = 3.5\text{ A}; I_B = 1\text{ A}; T_{mb} = 25\text{ }^\circ\text{C};$ see Figure 8 ; see Figure 9	[1]	-	0.6	1.5	V
V_{BEsat}	base-emitter saturation voltage	$I_C = 3.5\text{ A}; I_B = 1\text{ A}; T_{mb} = 25\text{ }^\circ\text{C};$ see Figure 10	[1]	-	1.1	1.5	V
h_{FE}	DC current gain	$I_C = 0.1\text{ A}; V_{CE} = 5\text{ V}; T_{mb} = 25\text{ }^\circ\text{C};$ see Figure 11	[1]	48	66	100	
		$I_C = 0.8\text{ A}; V_{CE} = 3\text{ V}; T_{mb} = 25\text{ }^\circ\text{C};$ see Figure 12	[1]	25	42	50	
Dynamic characteristics							
t_s	storage time	$I_C = 2.5\text{ A}; I_{B(on)} = 0.5\text{ A};$	-	-	3.5	μs	
t_f	fall time	$I_{B(off)} = -0.5\text{ A}; R_L = 60\text{ }\Omega;$ $V_{BB} = -5\text{ V}; T_{mb} = 25\text{ }^\circ\text{C};$ resistive load; $t_p = 300\text{ }\mu\text{s};$ see Figure 13 ; see Figure 14	-	-	500	ns	

[1] Pulse test: pulse duration $\leq 300\text{ }\mu\text{s}$, duty cycle $\leq 2\%$

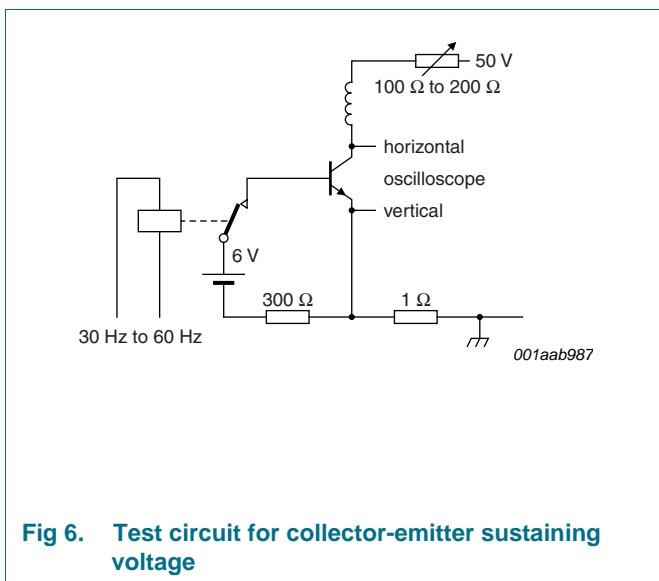

Fig 6. Test circuit for collector-emitter sustaining voltage

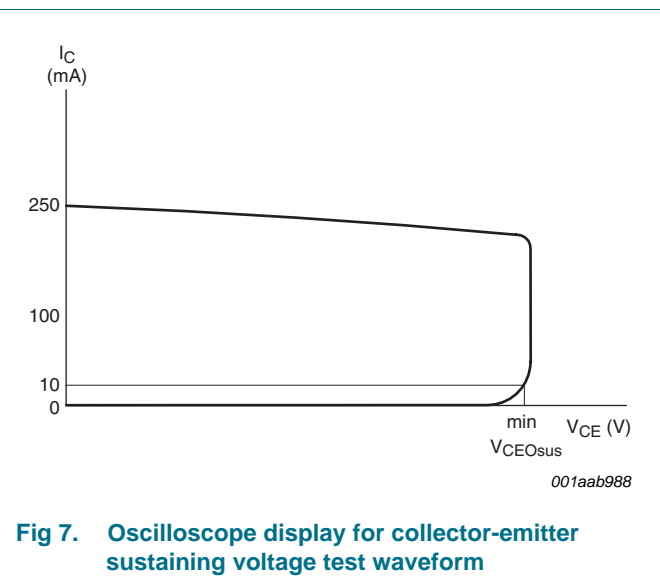
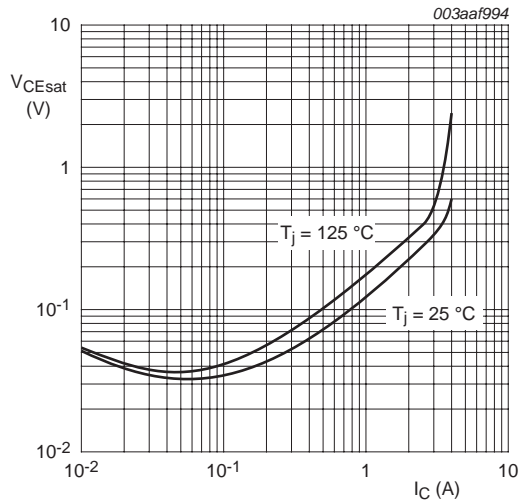

Fig 7. Oscilloscope display for collector-emitter sustaining voltage test waveform



$I_C / I_B = 3$

Fig 8. Collector-emitter saturation voltage as a function of collector current; typical values

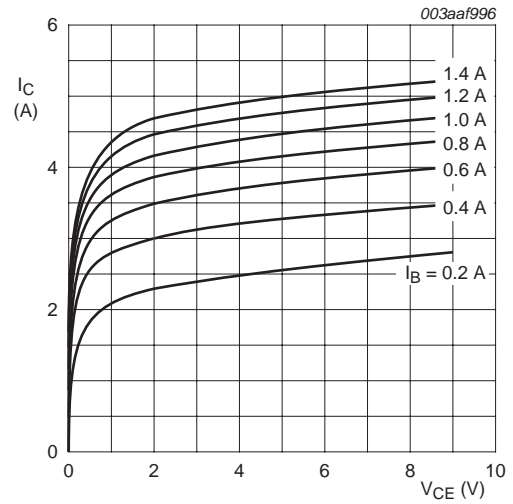
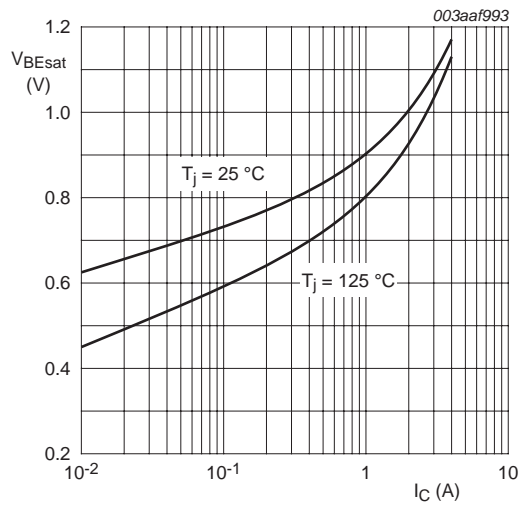

Fig 9. Collector current as a function of collector-emitter voltage; typical values



$I_C / I_B = 3$

Fig 10. Base-emitter saturation voltage as a function of collector current; typical values

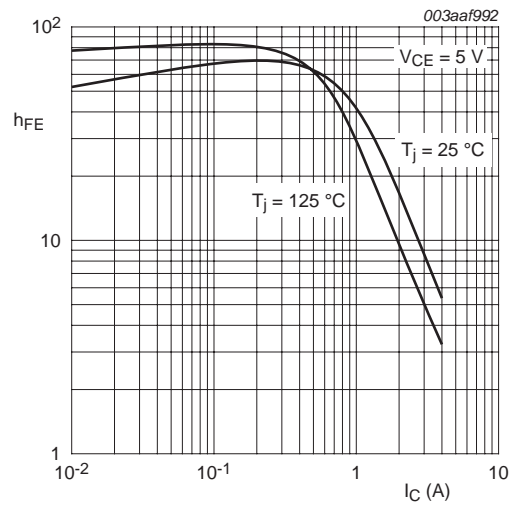

Fig 11. DC current gain as a function of collector current; typical values

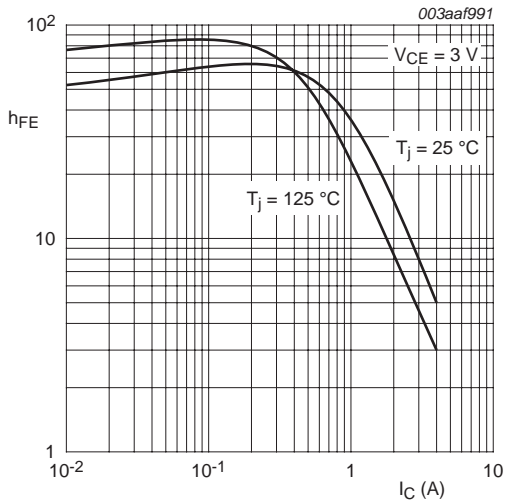
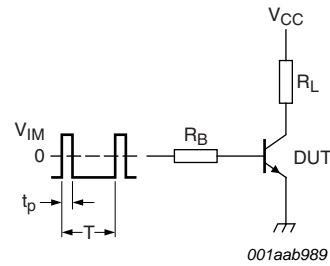

Fig 12. DC current gain as a function of collector current; typical values



$V_{IM} = -6 \text{ to } +8 \text{ V}; V_{CC} = 250 \text{ V}; t_p = 20 \mu\text{s}; \delta = \frac{t_p}{T} = 0.01$
 R_B and R_L calculated from I_{Con} and I_{Bon} requirements.

Fig 13. Test circuit for resistive load switching

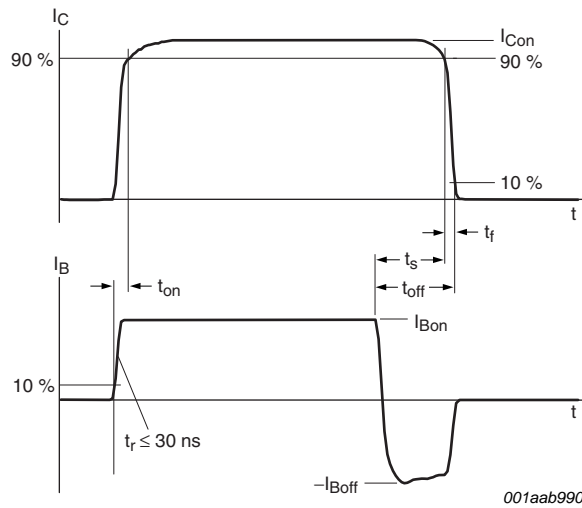

Fig 14. Switching times waveforms for resistive load

7. Package outline

Plastic single-ended package; heatsink mounted; 1 mounting hole; 3-lead TO-220AB

SOT78

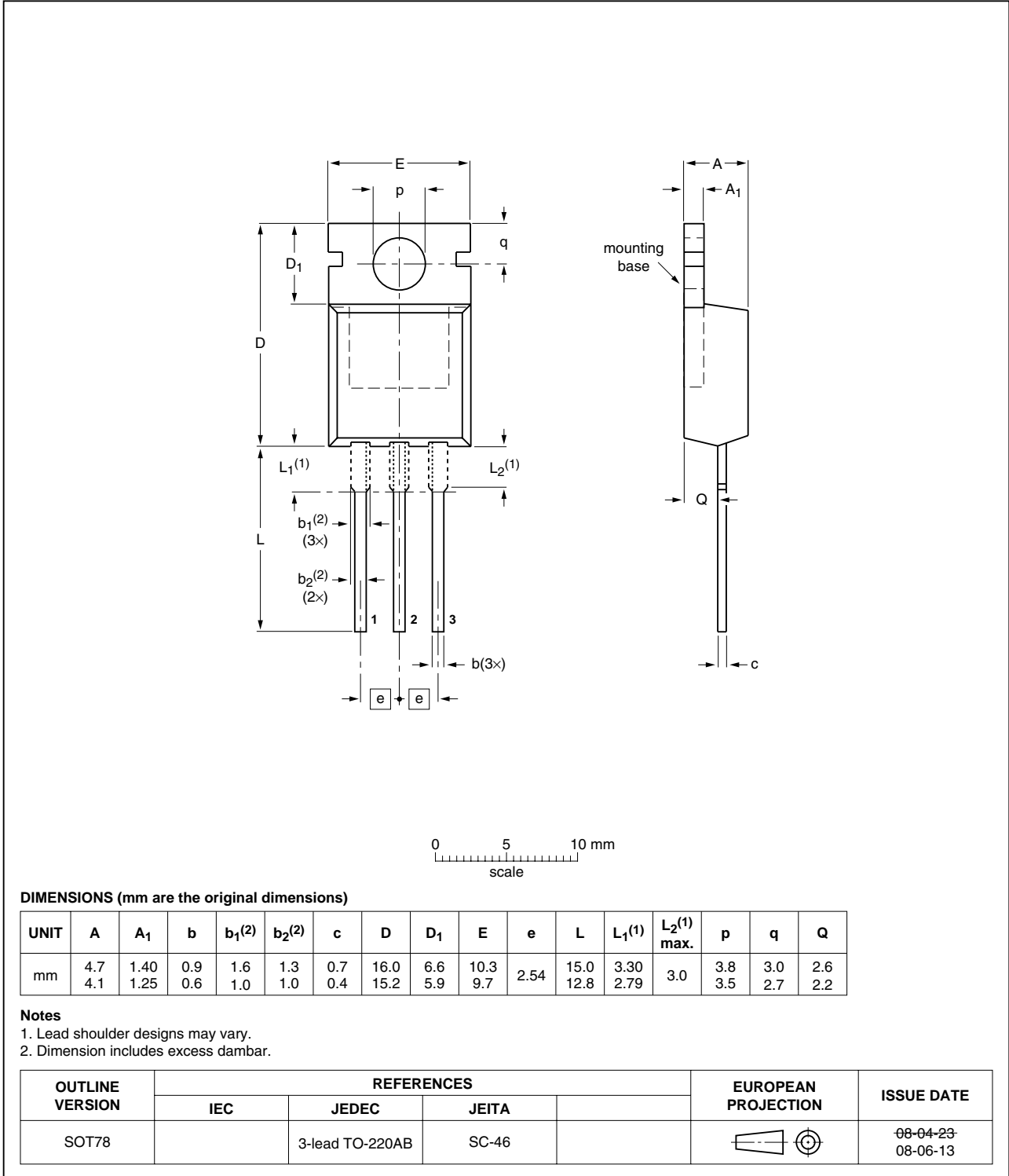

Fig 15. Package outline SOT78 (TO-220AB)

8. Revision history

Table 7. Revision history

Document ID	Release date	Data sheet status	Change notice	Supersedes
BUJ302A v.2	20110328	Product data sheet	-	BUJ302A v.1
Modifications:	<ul style="list-style-type: none">• The format of this data sheet has been redesigned to comply with the new identity guidelines of NXP Semiconductors.• Legal texts have been adapted to the new company name where appropriate.			
BUJ302A v.1	19980801	Objective specification	-	-

9. Legal information

9.1 Data sheet status

Document status ^[1] ^[2]	Product status ^[3]	Definition
Objective [short] data sheet	Development	This document contains data from the objective specification for product development.
Preliminary [short] data sheet	Qualification	This document contains data from the preliminary specification.
Product [short] data sheet	Production	This document contains the product specification.

[1] Please consult the most recently issued document before initiating or completing a design.

[2] The term 'short data sheet' is explained in section "Definitions".

[3] The product status of device(s) described in this document may have changed since this document was published and may differ in case of multiple devices. The latest product status information is available on the Internet at URL <http://www.nxp.com>.

9.2 Definitions

Draft — The document is a draft version only. The content is still under internal review and subject to formal approval, which may result in modifications or additions. NXP Semiconductors does not give any representations or warranties as to the accuracy or completeness of information included herein and shall have no liability for the consequences of use of such information.

Short data sheet — A short data sheet is an extract from a full data sheet with the same product type number(s) and title. A short data sheet is intended for quick reference only and should not be relied upon to contain detailed and full information. For detailed and full information see the relevant full data sheet, which is available on request via the local NXP Semiconductors sales office. In case of any inconsistency or conflict with the short data sheet, the full data sheet shall prevail.

Product specification — The information and data provided in a Product data sheet shall define the specification of the product as agreed between NXP Semiconductors and its customer, unless NXP Semiconductors and customer have explicitly agreed otherwise in writing. In no event however, shall an agreement be valid in which the NXP Semiconductors product is deemed to offer functions and qualities beyond those described in the Product data sheet.

9.3 Disclaimers

Limited warranty and liability — Information in this document is believed to be accurate and reliable. However, NXP Semiconductors does not give any representations or warranties, expressed or implied, as to the accuracy or completeness of such information and shall have no liability for the consequences of use of such information.

In no event shall NXP Semiconductors be liable for any indirect, incidental, punitive, special or consequential damages (including - without limitation - lost profits, lost savings, business interruption, costs related to the removal or replacement of any products or rework charges) whether or not such damages are based on tort (including negligence), warranty, breach of contract or any other legal theory.

Notwithstanding any damages that customer might incur for any reason whatsoever, NXP Semiconductors' aggregate and cumulative liability towards customer for the products described herein shall be limited in accordance with the *Terms and conditions of commercial sale* of NXP Semiconductors.

Right to make changes — NXP Semiconductors reserves the right to make changes to information published in this document, including without limitation specifications and product descriptions, at any time and without notice. This document supersedes and replaces all information supplied prior to the publication hereof.

Suitability for use — NXP Semiconductors products are not designed, authorized or warranted to be suitable for use in life support, life-critical or safety-critical systems or equipment, nor in applications where failure or malfunction of an NXP Semiconductors product can reasonably be expected to result in personal injury, death or severe property or environmental damage. NXP Semiconductors accepts no liability for inclusion and/or use of NXP Semiconductors products in such equipment or applications and therefore such inclusion and/or use is at the customer's own risk.

Quick reference data — The Quick reference data is an extract of the product data given in the Limiting values and Characteristics sections of this document, and as such is not complete, exhaustive or legally binding.

Applications — Applications that are described herein for any of these products are for illustrative purposes only. NXP Semiconductors makes no representation or warranty that such applications will be suitable for the specified use without further testing or modification.

Customers are responsible for the design and operation of their applications and products using NXP Semiconductors products, and NXP Semiconductors accepts no liability for any assistance with applications or customer product design. It is customer's sole responsibility to determine whether the NXP Semiconductors product is suitable and fit for the customer's applications and products planned, as well as for the planned application and use of customer's third party customer(s). Customers should provide appropriate design and operating safeguards to minimize the risks associated with their applications and products.

NXP Semiconductors does not accept any liability related to any default, damage, costs or problem which is based on any weakness or default in the customer's applications or products, or the application or use by customer's third party customer(s). Customer is responsible for doing all necessary testing for the customer's applications and products using NXP Semiconductors products in order to avoid a default of the applications and the products or of the application or use by customer's third party customer(s). NXP does not accept any liability in this respect.

Limiting values — Stress above one or more limiting values (as defined in the Absolute Maximum Ratings System of IEC 60134) will cause permanent damage to the device. Limiting values are stress ratings only and (proper) operation of the device at these or any other conditions above those given in the Recommended operating conditions section (if present) or the Characteristics sections of this document is not warranted. Constant or repeated exposure to limiting values will permanently and irreversibly affect the quality and reliability of the device.

Terms and conditions of commercial sale — NXP Semiconductors products are sold subject to the general terms and conditions of commercial sale, as published at <http://www.nxp.com/profile/terms>, unless otherwise agreed in a valid written individual agreement. In case an individual agreement is concluded only the terms and conditions of the respective

agreement shall apply. NXP Semiconductors hereby expressly objects to applying the customer's general terms and conditions with regard to the purchase of NXP Semiconductors products by customer.

No offer to sell or license — Nothing in this document may be interpreted or construed as an offer to sell products that is open for acceptance or the grant, conveyance or implication of any license under any copyrights, patents or other industrial or intellectual property rights.

Export control — This document as well as the item(s) described herein may be subject to export control regulations. Export might require a prior authorization from national authorities.

Non-automotive qualified products — Unless this data sheet expressly states that this specific NXP Semiconductors product is automotive qualified, the product is not suitable for automotive use. It is neither qualified nor tested in accordance with automotive testing or application requirements. NXP Semiconductors accepts no liability for inclusion and/or use of non-automotive qualified products in automotive equipment or applications.

In the event that customer uses the product for design-in and use in automotive applications to automotive specifications and standards, customer (a) shall use the product without NXP Semiconductors' warranty of the

product for such automotive applications, use and specifications, and (b) whenever customer uses the product for automotive applications beyond NXP Semiconductors' specifications such use shall be solely at customer's own risk, and (c) customer fully indemnifies NXP Semiconductors for any liability, damages or failed product claims resulting from customer design and use of the product for automotive applications beyond NXP Semiconductors' standard warranty and NXP Semiconductors' product specifications.

9.4 Trademarks

Notice: All referenced brands, product names, service names and trademarks are the property of their respective owners.

Adelante, Bitport, Bitsound, CoolFlux, CoReUse, DESFire, EZ-HV, FabKey, GreenChip, HiPerSmart, HITAG, I²C-bus logo, ICODE, I-CODE, ITEC, Labelution, MIFARE, MIFARE Plus, MIFARE Ultralight, MoReUse, QLPAK, Silicon Tuner, SiliconMAX, SmartXA, STARplug, TOPFET, TrenchMOS, TriMedia and UCODE — are trademarks of NXP B.V.

HD Radio and HD Radio logo — are trademarks of iBiquity Digital Corporation.

10. Contact information

For more information, please visit: <http://www.nxp.com>

For sales office addresses, please send an email to: salesaddresses@nxp.com

11. Contents

1	Product profile	1
1.1	General description	1
1.2	Features and benefits	1
1.3	Applications	1
1.4	Quick reference data	1
2	Pinning information	2
3	Ordering information	2
4	Limiting values	2
5	Thermal characteristics	5
6	Characteristics	6
7	Package outline	9
8	Revision history	10
9	Legal information	11
9.1	Data sheet status	11
9.2	Definitions	11
9.3	Disclaimers	11
9.4	Trademarks	12
10	Contact information	12

Please be aware that important notices concerning this document and the product(s) described herein, have been included in section 'Legal information'.

© NXP B.V. 2011.

All rights reserved.

For more information, please visit: <http://www.nxp.com>

For sales office addresses, please send an email to: salesaddresses@nxp.com

Date of release: 28 March 2011

Document identifier: BUJ302A