

isc N-Channel MOSFET Transistor
BUK453-100A/B
DESCRIPTION

- Drain Source Voltage-
: $V_{DSS}=100V(\text{Min})$
- LOW $R_{DS(\text{ON})}$
- Fast Switching Speed
- Minimum Lot-to-Lot variations for robust device performance and reliable operation

APPLICATIONS

- Designed for Switched Mode Power Supplies (SMPS), motor control, welding, and in general purpose switching resistance application

ABSOLUTE MAXIMUM RATINGS($T_a=25^\circ\text{C}$)

SYMBOL	PARAMETER	VALUE	UNIT
V_{DSS}	Drain-Source Voltage ($V_{GS}=0$)	100	V
V_{GS}	Gate-Source Voltage	± 30	V
I_D	Drain Current-continuous@ $TC=25^\circ\text{C}$	BUK453-100A	14
		BUK453-100B	13
P_{tot}	Total Dissipation@ $TC=25^\circ\text{C}$	75	W
T_j	Max. Operating Junction Temperature	175	$^\circ\text{C}$
T_{stg}	Storage Temperature Range	175	$^\circ\text{C}$

THERMAL CHARACTERISTICS

SYMBOL	PARAMETER	MAX	UNIT
$R_{th\ j-c}$	Thermal Resistance, Junction to Case	2.0	$^\circ\text{C}/\text{W}$
$R_{th\ j-a}$	Thermal Resistance, Junction to Ambient	60	$^\circ\text{C}/\text{W}$

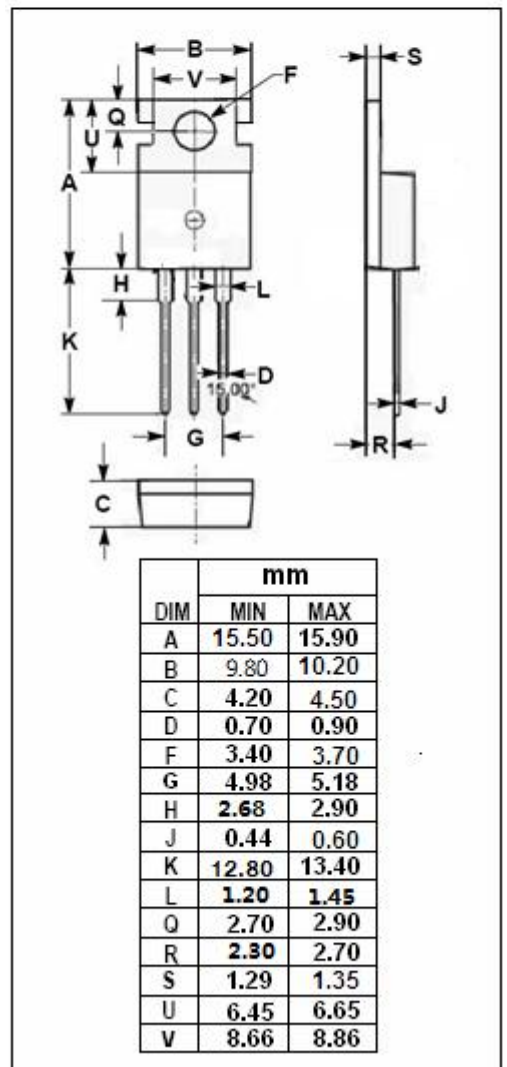
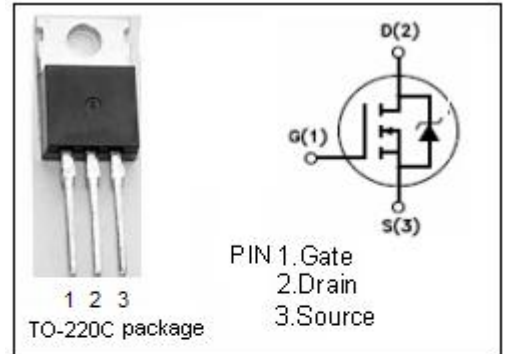

isc N-Channel Mosfet Transistor
BUK453-100A/B
• ELECTRICAL CHARACTERISTICS (T_c=25°C)

SYMBOL	PARAMETER	CONDITIONS	MIN	TYP	MAX	UNIT
V _{(BR)DSS}	Drain-Source Breakdown Voltage	V _{GS} =0; I _D = 0.25mA	100			V
V _{GS(th)}	Gate Threshold Voltage	V _{DS} =V _{GS} ; I _D =1mA	2.1		4.0	V
R _{DS(on)}	Drain-Source On-stage Resistance	V _{GS} =10V; I _D =5A	BUK453-100A		0.16	Ω
			BUK453-100B		0.20	Ω
I _{GSS}	Gate Source Leakage Current	V _{GS} = ±30V; V _{DS} = 0			±100	nA
I _{DSS}	Zero Gate Voltage Drain Current	V _{DS} =100V; V _{GS} = 0			10	uA
V _{SD}	Diode Forward Voltage	I _F =14A; V _{GS} =0			1.5	V
G _{fs}	Forward Transconductance	V _{DS} = 25V; I _D = 5A	4.0			S
t _r	Rise time	V _{GS} =10V; I _D =3A; R _{GS} =50 Ω		25	40	ns
t _{on}	Turn-on time			10	20	ns
t _f	Fall time			40	55	ns
t _{off}	Turn-off time			60	90	ns

NOTICE:

ISC reserves the rights to make changes of the content herein the datasheet at any time without notification. The information contained herein is presented only as a guide for the applications of our products.

ISC products are intended for usage in general electronic equipment. The products are not designed for use in equipment which require specialized quality and/or reliability, or in equipment which could have applications in hazardous environments, aerospace industry, or medical field. Please contact us if you intend our products to be used in these special applications.

ISC makes no warranty or guarantee regarding the suitability of its products for any particular purpose, nor does ISC assume any liability arising from the application or use of any products, and specifically disclaims any and all liability, including without limitation special, consequential or incidental damages.