

BUK765R2-40B

N-channel TrenchMOS standard level FET

Rev. 02 — 16 January 2009

Product data sheet

1. Product profile

1.1 General description

Standard level N-channel enhancement mode Field-Effect Transistor (FET) in a plastic package using TrenchMOS technology. This product has been designed and qualified to the appropriate AEC standard for use in automotive critical applications.

1.2 Features and benefits

- Q101 compliant
- Suitable for standard level gate drive sources
- Suitable for thermally demanding environments due to 175 °C rating

1.3 Applications

- 12 V loads
- Automotive systems
- General purpose power switching
- Motors, lamps and solenoids

1.4 Quick reference data

Table 1. Quick reference

Symbol	Parameter	Conditions	Min	Typ	Max	Unit
V_{DS}	drain-source voltage	$T_j \geq 25\text{ °C}; T_j \leq 175\text{ °C}$	-	-	40	V
I_D	drain current	$V_{GS} = 10\text{ V}; T_{mb} = 25\text{ °C};$ see Figure 1 ; see Figure 3 ;	[1]	-	75	A
P_{tot}	total power dissipation	$T_{mb} = 25\text{ °C};$ see Figure 2	-	-	203	W
Avalanche ruggedness						
$E_{DS(AL)S}$	non-repetitive drain-source avalanche energy	$I_D = 75\text{ A}; V_{sup} \leq 40\text{ V};$ $R_{GS} = 50\text{ }\Omega; V_{GS} = 10\text{ V};$ $T_{j(init)} = 25\text{ °C};$ unclamped	-	-	494	mJ
Dynamic characteristics						
Q_{GD}	gate-drain charge	$V_{GS} = 10\text{ V}; I_D = 25\text{ A};$ $V_{DS} = 32\text{ V}; T_j = 25\text{ °C};$ see Figure 14	-	16	-	nC
Static characteristics						
R_{DSon}	drain-source on-state resistance	$V_{GS} = 10\text{ V}; I_D = 25\text{ A};$ $T_j = 25\text{ °C};$ see Figure 11 ; see Figure 12	-	4.4	5.2	m Ω

[1] Continuous current is limited by package.

2. Pinning information

Table 2. Pinning information

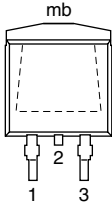
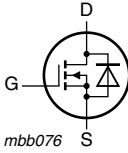
Pin	Symbol	Description	Simplified outline	Graphic symbol
1	G	gate	 <p>SOT404 (D2PAK)</p>	 <p><i>mbb076</i></p>
2	D	drain [1]		
3	S	source		
mb	D	mounting base; connected to drain		

[1] It is not possible to make a connection to pin 2.

3. Ordering information

Table 3. Ordering information

Type number	Package		Version
	Name	Description	
BUK765R2-40B	D2PAK	plastic single-ended surface-mounted package (D2PAK); 3 leads (one lead cropped)	SOT404

4. Limiting values

Table 4. Limiting values

In accordance with the Absolute Maximum Rating System (IEC 60134).

Symbol	Parameter	Conditions	Min	Max	Unit	
V_{DS}	drain-source voltage	$T_j \geq 25\text{ °C}; T_j \leq 175\text{ °C}$	-	40	V	
V_{DGR}	drain-gate voltage	$R_{GS} = 20\text{ k}\Omega$	-	40	V	
V_{GS}	gate-source voltage		-20	20	V	
I_D	drain current	$T_{mb} = 25\text{ °C}; V_{GS} = 10\text{ V};$ see Figure 1 ; see Figure 3 ; [1]	-	143	A	
		$T_{mb} = 25\text{ °C}; V_{GS} = 10\text{ V};$ see Figure 1 ; see Figure 3 ; [2]	-	75	A	
		$T_{mb} = 100\text{ °C}; V_{GS} = 10\text{ V};$ see Figure 1 ; [2]	-	75	A	
I_{DM}	peak drain current	$T_{mb} = 25\text{ °C}; t_p \leq 10\text{ }\mu\text{s};$ pulsed; see Figure 3	-	573	A	
P_{tot}	total power dissipation	$T_{mb} = 25\text{ °C};$ see Figure 2	-	203	W	
T_{stg}	storage temperature		-55	175	°C	
T_j	junction temperature		-55	175	°C	
Source-drain diode						
I_S	source current	$T_{mb} = 25\text{ °C};$	[1]	-	143	A
		$T_{mb} = 25\text{ °C};$	[2]	-	75	A
I_{SM}	peak source current	$t_p \leq 10\text{ }\mu\text{s};$ pulsed; $T_{mb} = 25\text{ °C}$	-	573	A	
Avalanche ruggedness						
$E_{DS(AL)S}$	non-repetitive drain-source avalanche energy	$I_D = 75\text{ A}; V_{sup} \leq 40\text{ V}; R_{GS} = 50\text{ }\Omega; V_{GS} = 10\text{ V};$ $T_{j(init)} = 25\text{ °C};$ unclamped	-	494	mJ	

[1] Current is limited by power dissipation chip rating.

[2] Continuous current is limited by package.

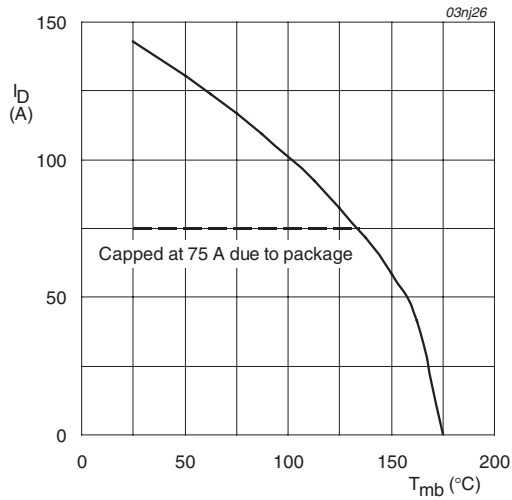

$$V_{GS} \geq 4.5V$$

Fig 1. Continuous drain current as a function of mounting base temperature

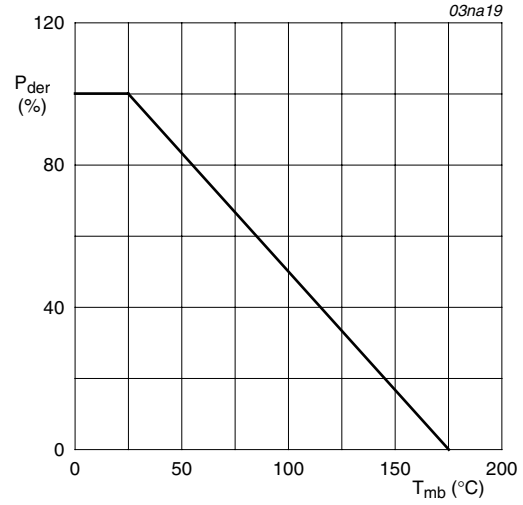

$$P_{der} = \frac{P_{tot}}{P_{tot(25^{\circ}C)}} \times 100\%$$

Fig 2. Normalized total power dissipation as a function of mounting base temperature

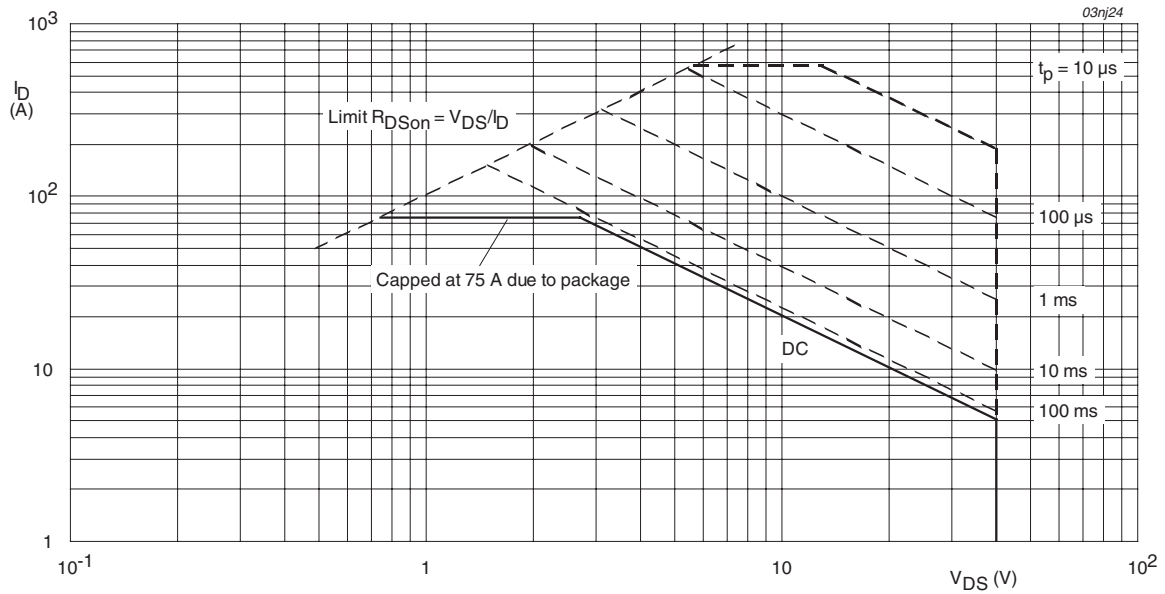

$$T_{mb} = 25^{\circ}C; I_{DM} \text{ is single pulse}$$

Fig 3. Safe operating area; continuous and peak drain currents as a function of drain-source voltage

5. Thermal characteristics

Table 5. Thermal characteristics

Symbol	Parameter	Conditions	Min	Typ	Max	Unit
$R_{th(j-mb)}$	thermal resistance from junction to mounting base	see Figure 4	-	-	0.74	K/W
$R_{th(j-a)}$	thermal resistance from junction to ambient	minimum footprint; mounted on a printed-circuit board	-	50	-	K/W

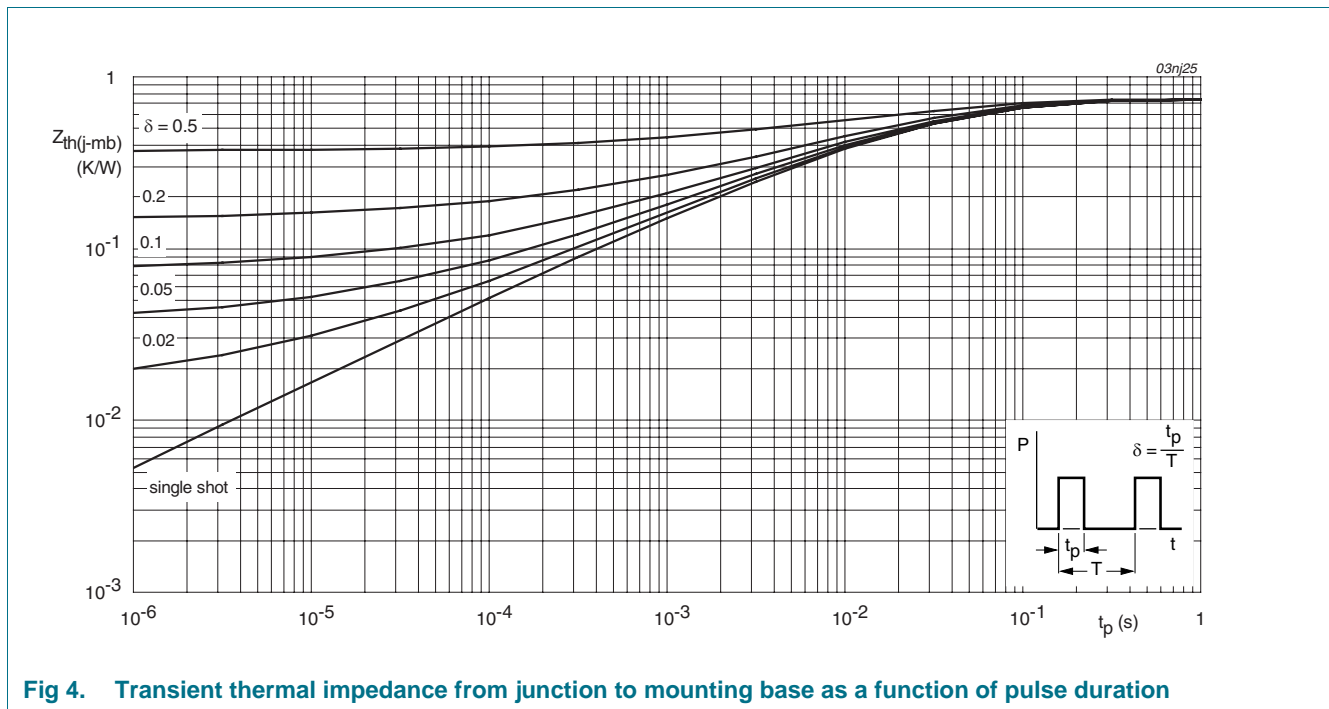
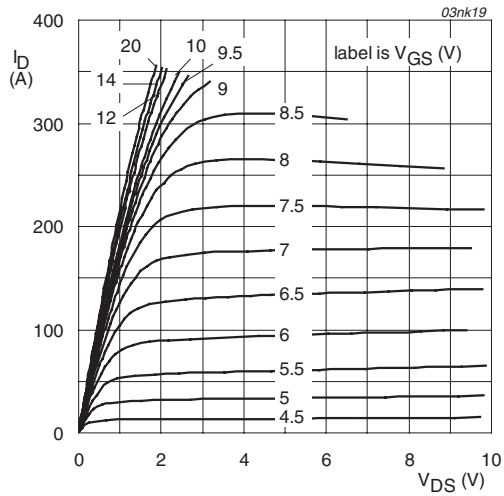

Fig 4. Transient thermal impedance from junction to mounting base as a function of pulse duration

6. Characteristics

Table 6. Characteristics

Symbol	Parameter	Conditions	Min	Typ	Max	Unit
Static characteristics						
$V_{(BR)DSS}$	drain-source breakdown voltage	$I_D = 0.25 \text{ mA}; V_{GS} = 0 \text{ V}; T_j = 25 \text{ }^\circ\text{C}$	40	-	-	V
		$I_D = 0.25 \text{ mA}; V_{GS} = 0 \text{ V}; T_j = -55 \text{ }^\circ\text{C}$	36	-	-	V
$V_{GS(th)}$	gate-source threshold voltage	$I_D = 1 \text{ mA}; V_{DS} = V_{GS}; T_j = 25 \text{ }^\circ\text{C}$; see Figure 10	2	3	4	V
		$I_D = 1 \text{ mA}; V_{DS} = V_{GS}; T_j = 175 \text{ }^\circ\text{C}$; see Figure 10	1	-	-	V
		$I_D = 1 \text{ mA}; V_{DS} = V_{GS}; T_j = -55 \text{ }^\circ\text{C}$; see Figure 10	-	-	4.4	V
I_{DSS}	drain leakage current	$V_{DS} = 40 \text{ V}; V_{GS} = 0 \text{ V}; T_j = 25 \text{ }^\circ\text{C}$	-	0.02	1	μA
		$V_{DS} = 40 \text{ V}; V_{GS} = 0 \text{ V}; T_j = 175 \text{ }^\circ\text{C}$	-	-	500	μA
I_{GSS}	gate leakage current	$V_{DS} = 0 \text{ V}; V_{GS} = 20 \text{ V}; T_j = 25 \text{ }^\circ\text{C}$	-	2	100	nA
		$V_{DS} = 0 \text{ V}; V_{GS} = -20 \text{ V}; T_j = 25 \text{ }^\circ\text{C}$	-	2	100	nA
$R_{DS(on)}$	drain-source on-state resistance	$V_{GS} = 10 \text{ V}; I_D = 25 \text{ A}; T_j = 25 \text{ }^\circ\text{C}$; see Figure 11 ; see Figure 12	-	4.4	5.2	m Ω
		$V_{GS} = 10 \text{ V}; I_D = 25 \text{ A}; T_j = 175 \text{ }^\circ\text{C}$; see Figure 11 ; see Figure 12	-	-	9.9	m Ω
Dynamic characteristics						
$Q_{G(tot)}$	total gate charge	$I_D = 25 \text{ A}; V_{DS} = 32 \text{ V}; V_{GS} = 10 \text{ V}; T_j = 25 \text{ }^\circ\text{C}$; see Figure 14	-	52	-	nC
Q_{GS}	gate-source charge		-	12	-	nC
Q_{GD}	gate-drain charge		-	16	-	nC
C_{iss}	input capacitance	$V_{GS} = 0 \text{ V}; V_{DS} = 25 \text{ V}; f = 1 \text{ MHz}; T_j = 25 \text{ }^\circ\text{C}$; see Figure 15	-	2842	3789	pF
C_{oss}	output capacitance		-	711	853	pF
C_{rss}	reverse transfer capacitance		-	296	406	pF
$t_{d(on)}$	turn-on delay time	$V_{DS} = 30 \text{ V}; R_L = 1.2 \text{ } \Omega; V_{GS} = 10 \text{ V}; R_{G(ext)} = 10 \text{ } \Omega; T_j = 25 \text{ }^\circ\text{C}$	-	15	-	ns
t_r	rise time		-	51	-	ns
$t_{d(off)}$	turn-off delay time		-	81	-	ns
t_f	fall time		-	56	-	ns
L_D	internal drain inductance	from drain lead 6 mm from package to centre of die; $T_j = 25 \text{ }^\circ\text{C}$	-	4.5	-	nH
		from upper edge of drain mounting base to centre of die; $T_j = 25 \text{ }^\circ\text{C}$	-	2.5	-	nH
L_S	internal source inductance	from source lead to source bond pad; $T_j = 25 \text{ }^\circ\text{C}$	-	7.5	-	nH
Source-drain diode						
V_{SD}	source-drain voltage	$I_S = 25 \text{ A}; V_{GS} = 0 \text{ V}; T_j = 25 \text{ }^\circ\text{C}$; see Figure 13	-	0.85	1.2	V
t_{rr}	reverse recovery time	$I_S = 20 \text{ A}; di_S/dt = -100 \text{ A}/\mu\text{s}; V_{GS} = -10 \text{ V}; V_{DS} = 20 \text{ V}; T_j = 25 \text{ }^\circ\text{C}$	-	54	-	ns
Q_r	recovered charge		-	38	-	nC



$T_j = 25^\circ\text{C}; t_p = 300\mu\text{s}$

Fig 5. Output characteristics: drain current as a function of drain-source voltage; typical values

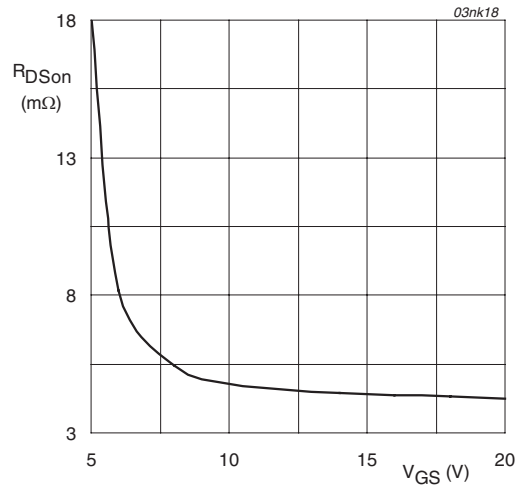

$T_j = 25^\circ\text{C}; I_D = 25\text{A}$

Fig 6. Drain-source on-state resistance as a function of gate-source voltage; typical values

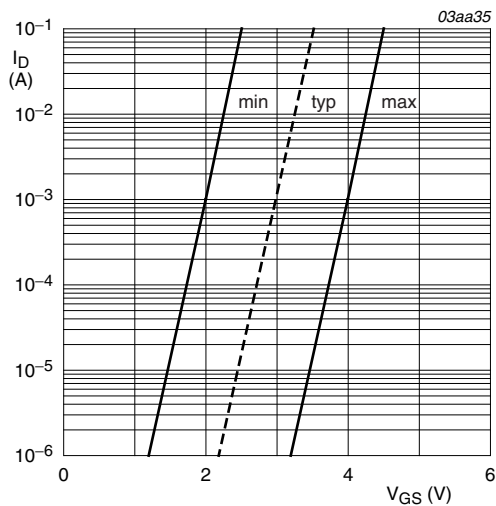

$T_j = 25^\circ\text{C}; V_{DS} = 5\text{V}$

Fig 7. Sub-threshold drain current as a function of gate-source voltage

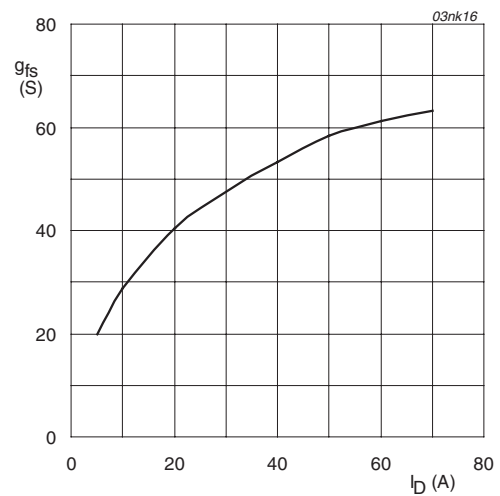

$T_j = 25^\circ\text{C}; V_{DS} = 25\text{V}$

Fig 8. Forward transconductance as a function of drain current; typical values

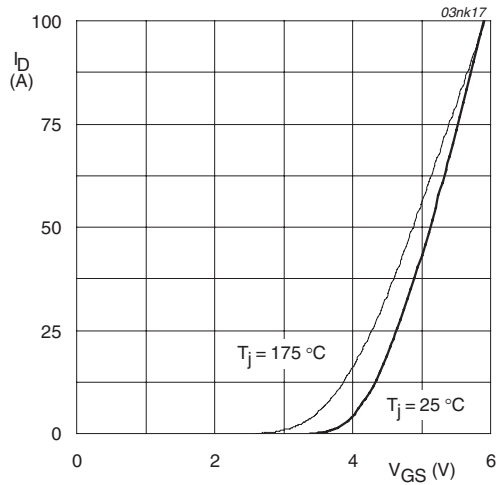

$$V_{DS} = 25V$$

Fig 9. Transfer characteristics: drain current as a function of gate-source voltage; typical values

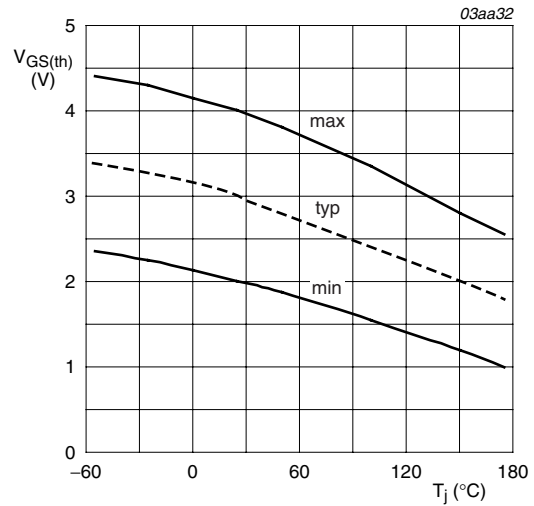

$$I_D = 1mA; V_{DS} = V_{GS}$$

Fig 10. Gate-source threshold voltage as a function of junction temperature

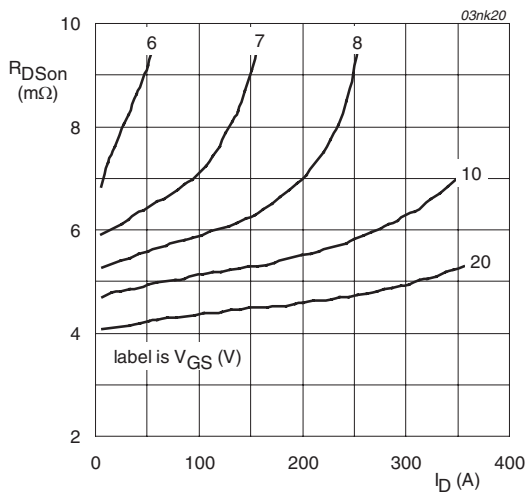

$$T_j = 25^\circ C$$

Fig 11. Drain-source on-state resistance as a function of drain current; typical values

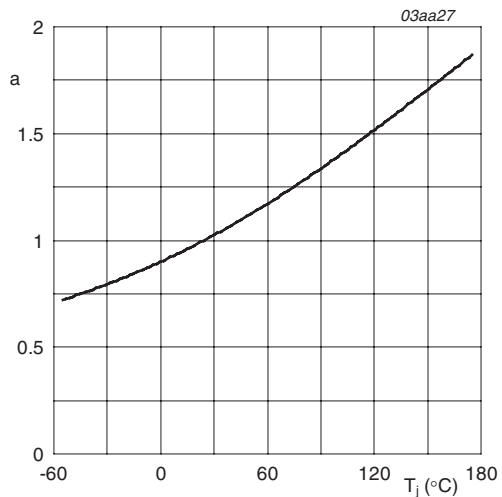

$$a = \frac{R_{DSon}}{R_{DSon(25^\circ C)}}$$

Fig 12. Normalized drain-source on-state resistance factor as a function of junction temperature

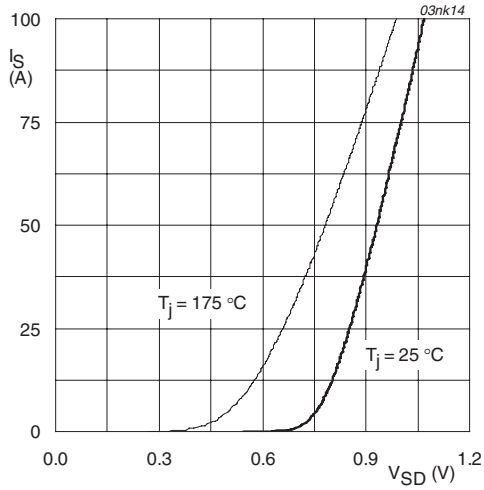

$V_{GS} = 0V$

Fig 13. Source current as a function of source-drain voltage; typical values

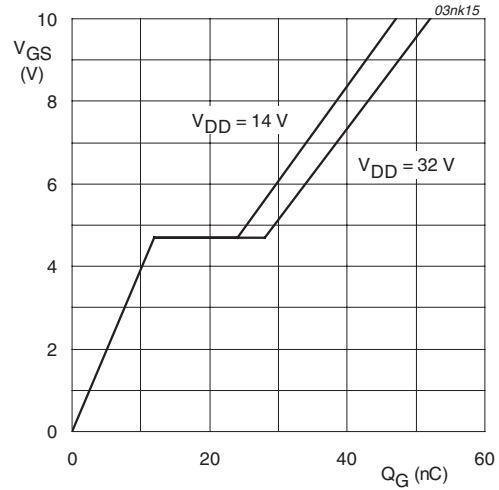

$T_j = 25^{\circ}C; I_D = 25A$

Fig 14. Gate-source voltage as a function of gate charge; typical values

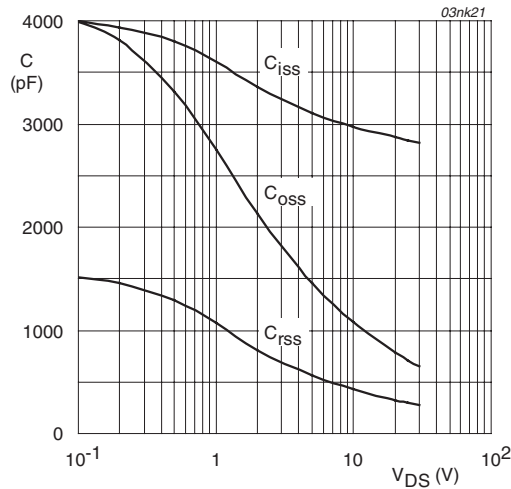

$V_{GS} = 0V; f = 1MHz$

Fig 15. Input, output and reverse transfer capacitances as a function of drain-source voltage; typical values

7. Package outline

Plastic single-ended surface-mounted package (D2PAK); 3 leads (one lead cropped)

SOT404

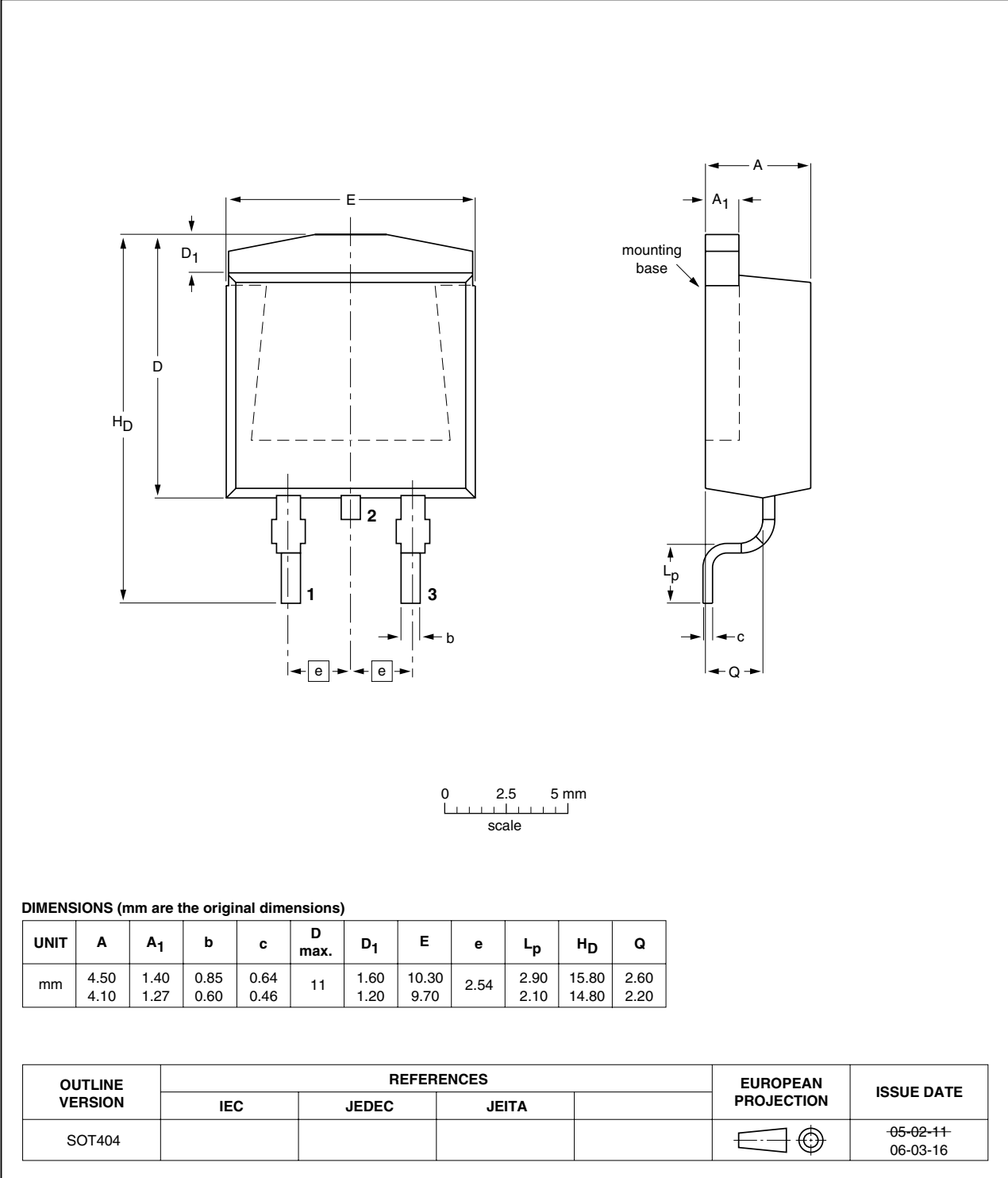

Fig 16. Package outline SOT404 (D2PAK)

8. Revision history

Table 7. Revision history

Document ID	Release date	Data sheet status	Change notice	Supersedes
BUK765R2-40B_2	20090116	Product data sheet	-	BUK75_765R2_40B-01
Modifications:		<ul style="list-style-type: none">• The format of this data sheet has been redesigned to comply with the new identity guidelines of NXP Semiconductors.• Legal texts have been adapted to the new company name where appropriate.• Type number BUK765R2-40B separated from data sheet BUK75_765R2_40B-01.• Package outline updated.		
BUK75_765R2_40B-01	20030514	Product data sheet	-	-

9. Legal information

9.1 Data sheet status

Document status ^{[1][2]}	Product status ^[3]	Definition
Objective [short] data sheet	Development	This document contains data from the objective specification for product development.
Preliminary [short] data sheet	Qualification	This document contains data from the preliminary specification.
Product [short] data sheet	Production	This document contains the product specification.

[1] Please consult the most recently issued document before initiating or completing a design.

[2] The term 'short data sheet' is explained in section "Definitions".

[3] The product status of device(s) described in this document may have changed since this document was published and may differ in case of multiple devices. The latest product status information is available on the Internet at URL <http://www.nxp.com>.

9.2 Definitions

Draft — The document is a draft version only. The content is still under internal review and subject to formal approval, which may result in modifications or additions. NXP Semiconductors does not give any representations or warranties as to the accuracy or completeness of information included herein and shall have no liability for the consequences of use of such information.

Short data sheet — A short data sheet is an extract from a full data sheet with the same product type number(s) and title. A short data sheet is intended for quick reference only and should not be relied upon to contain detailed and full information. For detailed and full information see the relevant full data sheet, which is available on request via the local NXP Semiconductors sales office. In case of any inconsistency or conflict with the short data sheet, the full data sheet shall prevail.

9.3 Disclaimers

General — Information in this document is believed to be accurate and reliable. However, NXP Semiconductors does not give any representations or warranties, expressed or implied, as to the accuracy or completeness of such information and shall have no liability for the consequences of use of such information.

Right to make changes — NXP Semiconductors reserves the right to make changes to information published in this document, including without limitation specifications and product descriptions, at any time and without notice. This document supersedes and replaces all information supplied prior to the publication hereof.

Suitability for use — NXP Semiconductors products are not designed, authorized or warranted to be suitable for use in medical, military, aircraft, space or life support equipment, nor in applications where failure or malfunction of an NXP Semiconductors product can reasonably be expected to result in personal injury, death or severe property or environmental damage. NXP Semiconductors accepts no liability for inclusion and/or use of NXP Semiconductors products in such equipment or applications and therefore such inclusion and/or use is at the customer's own risk.

Applications — Applications that are described herein for any of these products are for illustrative purposes only. NXP Semiconductors makes no representation or warranty that such applications will be suitable for the specified use without further testing or modification.

Quick reference data — The Quick reference data is an extract of the product data given in the Limiting values and Characteristics sections of this document, and as such is not complete, exhaustive or legally binding.

Limiting values — Stress above one or more limiting values (as defined in the Absolute Maximum Ratings System of IEC 60134) may cause permanent damage to the device. Limiting values are stress ratings only and operation of the device at these or any other conditions above those given in the Characteristics sections of this document is not implied. Exposure to limiting values for extended periods may affect device reliability.

Terms and conditions of sale — NXP Semiconductors products are sold subject to the general terms and conditions of commercial sale, as published at <http://www.nxp.com/profile/terms>, including those pertaining to warranty, intellectual property rights infringement and limitation of liability, unless explicitly otherwise agreed to in writing by NXP Semiconductors. In case of any inconsistency or conflict between information in this document and such terms and conditions, the latter will prevail.

No offer to sell or license — Nothing in this document may be interpreted or construed as an offer to sell products that is open for acceptance or the grant, conveyance or implication of any license under any copyrights, patents or other industrial or intellectual property rights.

9.4 Trademarks

Notice: All referenced brands, product names, service names and trademarks are the property of their respective owners.

TrenchMOS — is a trademark of NXP B.V.

10. Contact information

For more information, please visit: <http://www.nxp.com>

For sales office addresses, please send an email to: salesaddresses@nxp.com

11. Contents

1	Product profile	1
1.1	General description	1
1.2	Features and benefits	1
1.3	Applications	1
1.4	Quick reference data	1
2	Pinning information	2
3	Ordering information	2
4	Limiting values	3
5	Thermal characteristics	5
6	Characteristics	6
7	Package outline	10
8	Revision history	11
9	Legal information	12
9.1	Data sheet status	12
9.2	Definitions	12
9.3	Disclaimers	12
9.4	Trademarks	12
10	Contact information	12

Please be aware that important notices concerning this document and the product(s) described herein, have been included in section 'Legal information'.



© NXP B.V. 2009.

All rights reserved.

For more information, please visit: <http://www.nxp.com>

For sales office addresses, please send an email to: salesaddresses@nxp.com

Date of release: 16 January 2009

Document identifier: BUK765R2-40B_2