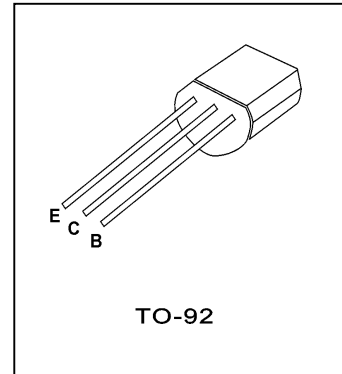

BUL SERIES TRANSISTORS**BUL6822**

- **FEATURES:** ■ HIGH VOLTAGE CAPABILITY ■ HIGH SPEED SWITCHING ■ WIDE SOA
- **APPLICATION:** ■ FLUORESCENT LAMP ■ ELECTRONIC BALLAST

● **Absolute Maximum Ratings (Tc=25°C)****TO-92**

PARAMETER	SYMBOL	VALUE	UNIT
Collector-Base Voltage	V_{CB0}	600	V
Collector-Emitter Voltage	V_{CEO}	400	V
Emitter- Base Voltage	V_{EBO}	9	V
Collector Current	I_C	0.8	A
Total Power Dissipation	P_C	10	W
Junction Temperature	T_j	150	°C
Storage Temperature	T_{stg}	-65-150	°C

● **Electronic Characteristics (Tc=25°C)**

CHARACTERISTICS	SYMBOL	TEST CONDITION	MIN	MAX	UNIT
Collector-Base Cutoff Current	I_{CBO}	$V_{CB}=600V$		100	μA
Collector-Emitter Cutoff Current	I_{CEO}	$V_{CE}=400V, I_B=0$		250	μA
Collector-Emitter Voltage	V_{CEO}	$I_C=10mA, I_B=0$	400		V
Emitter- Base Voltage	V_{EBO}	$I_E=1mA, I_C=0$	9		V
Collector-Emitter Saturation Voltage	V_{ces}	$I_C=0.1A, I_B=10mA$		0.5	V
		$I_C=0.5A, I_B=0.1A$		0.8	
Base-Emitter Saturation Voltage	V_{besat}	$I_C=0.1A, I_B=10mA$		1.0	V
DC Current Gain	h_{FE}	$V_{CE}=5V, I_C=1mA$	7		
		$V_{CE}=10V, I_C=0.1A$	10	40	
		$V_{CE}=5V, I_C=0.8A$	5		
Storage Time	t_s	$V_{CC}=5V,$ $I_C=0.1A,$ (UI9600)	2.0	4.2	μS
Falling Time	t_f			0.9	

BUL SERIES TRANSISTORS

BUL6822

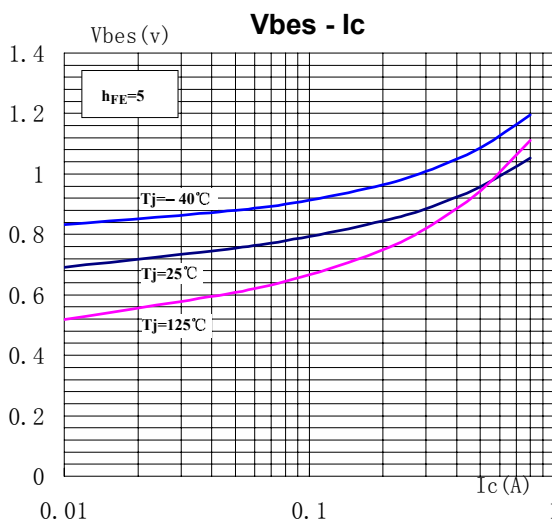
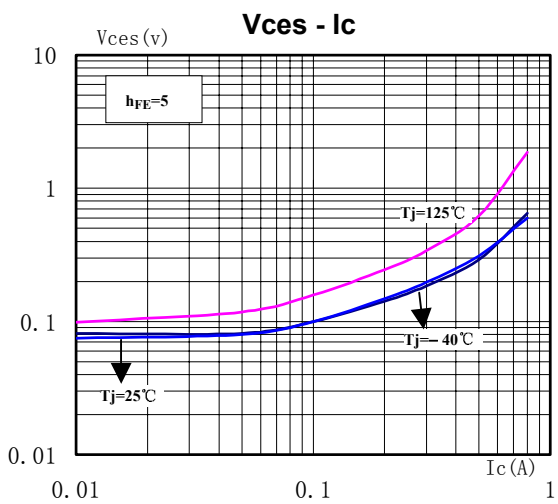
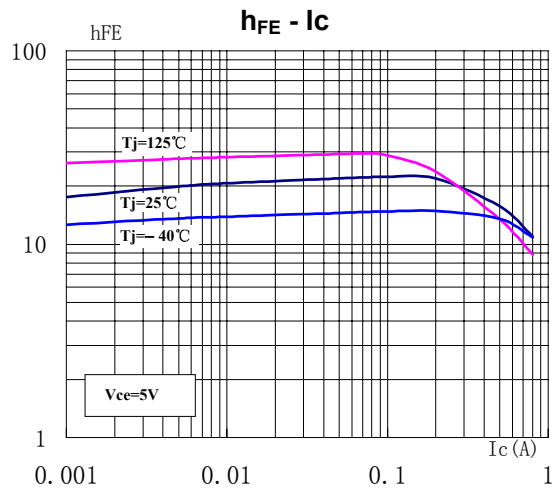
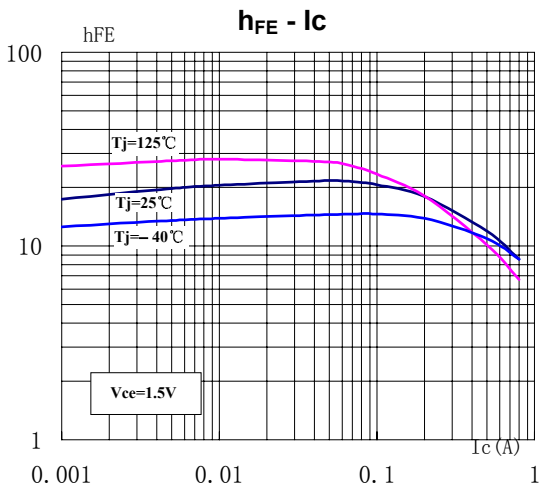
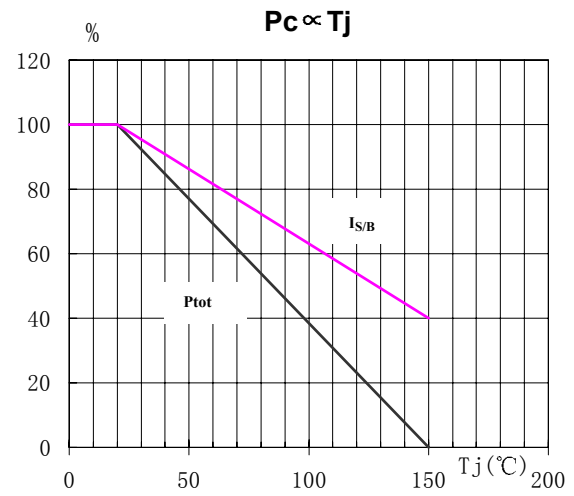
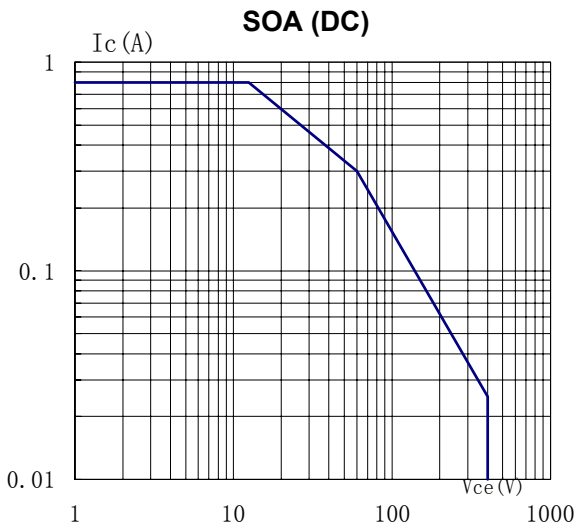

TO-92 MECHANICAL DATA

UNIT: mm

SYMBOL	min	nom	max
A	4.3		5.3
b	0.3		
c	0.3		
ϕD	4.3		5.2
D			
d	1.0		1.7
E	3.2		4.2
e		2.54	
e1		1.27	
L	12.7		
L1			2.0

