

File Number 1172

BUX21

Silicon N-P-N Switching Transistor

For Switching Applications in
Industrial and Commercial Equipment

Features:

- $V_{CE0} - 200V$
- $I_C - 40 A$
- $P_T - 250 W$

TERMINAL DESIGNATIONS

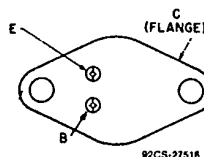

JEDEC TO-204AA

The RCA-BUX21 is a silicon n-p-n power transistor featuring fast switching speeds, low saturation voltage, and high safe-operating-area (SOA) ratings. It is specially designed for converters, inverters, pulse-width-modulated regulators, and a variety of power switching circuits.

The RCA-BUX21 transistor is supplied in a steel JEDEC TO-204AA hermetic package.

MAXIMUM RATINGS, Absolute-Maximum Values:

	BUX21	
V_{CBO}	250	V
$V_{CE0(SUS)}$	200	V
$V_{CEX(SUS)}$		
$V_{BE} = -1.5V$	250	V
$V_{CER(SUS)}$		
$R_{BE} = 100 \Omega$	240	V
V_{EBO}	7	V
I_C	40	A
I_{CM}	50	A
I_B	8	A
P_T		
At T_C up to 25°C and V_{CE} up to 20 V	250	W
T_J, T_{stg}	-65 to +200	°C
T_L		
At distances $\geq 1/16$ in. (1.58 mm) from case for 10 s max.	200	°C

3875081 G E SOLID STATE
Pro Electron Power Transistors

01E 17609 DT-33-15

BUX21

ELECTRICAL CHARACTERISTICS, at Case Temperature (T_C) = 25°C unless otherwise specified

CHARACTERISTIC	TEST CONDITIONS				LIMITS			UNITS
	VOLTAGE V dc		CURRENT A dc		BUX21			
	V_{CE}	V_{BE}	I_C	I_B	Min.	Typ.	Max.	
I_{CEO}	160	—	—	0	—	—	3	mA
I_{CEV}	250	-1.5	—	—	—	—	3	
$T_C = 125^\circ C$	250	-1.5	—	—	—	—	12	
I_{EBO}	—	-5	0	—	—	—	1	
$V_{CEO(sus)}^b$	—	—	0.2 ^a	—	200 ^a	—	—	V
$V_{(BR)EBO} I_E = 0.05 A$	—	—	0	—	7	—	—	V
$V_{BE(sat)}$	—	—	25 ^a	3	—	1.2	1.5	
$V_{CE(sat)}$	—	—	12 ^a 25 ^a	1.2 3	—	0.2 0.7	0.6 1.5	
h_{FE}	2 4	—	12 ^a 25 ^a	—	20 10	—	60	
$I_{S/b}$ $t = 1s, nonrepetitive$	140 20	—	—	—	0.15 12.5	—	—	A
f_T $f = 10 MHz$	15	—	2	—	8	—	—	MHz
t_{on}	$V_{CC} = 100 V$	—	25	3	—	0.3	1.2	μs
t_s ($I_{B1} = I_{B2}$)	$V_{CC} = 100 V$	—	25	3	—	1.0	1.8	
t_f ($I_{B1} = I_{B2}$)	$V_{CC} = 100 V$	—	25	3	—	0.2	0.4	
$R_{\theta JC}$	—	—	—	—	—	—	0.7	$^\circ C/W$

^a Pulsed, pulse duration = 300 μs , duty factor $\leq 2\%$.

^b CAUTION: Sustaining Voltages $V_{CEO(sus)}$ MUST NOT be measured on a curver tracer.

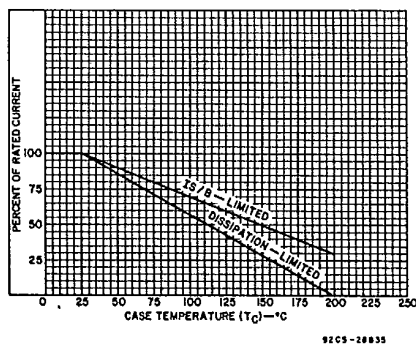

Fig. 1 — Dissipation and $I_{S/b}$ derating curve.

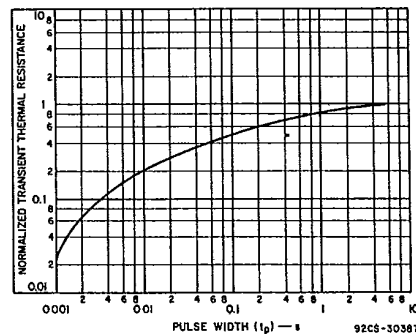

Fig. 2 — Typical thermal-response characteristic.

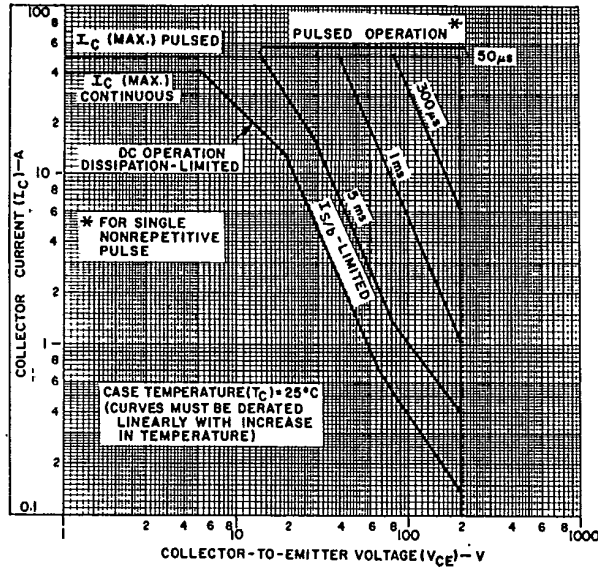

Fig. 3 — Maximum operating areas ($T_c = 25^\circ\text{C}$), 92CM-31448

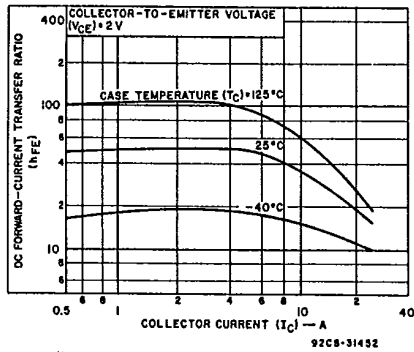

Fig. 4 — Typical dc beta characteristics, 92CS-31452

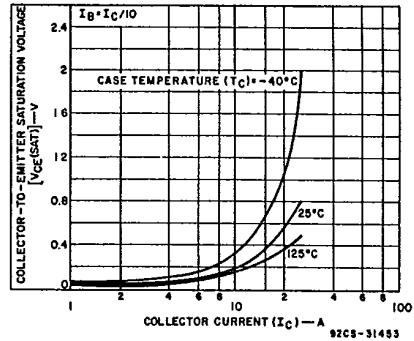

Fig. 5 — Typical collector-to-emitter saturation voltage characteristics, 92CS-31453

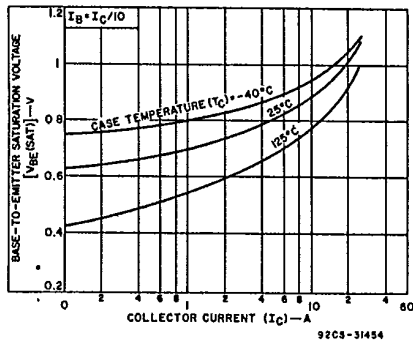

Fig. 6 — Typical base-to-emitter saturation voltage characteristics, 92CS-31454

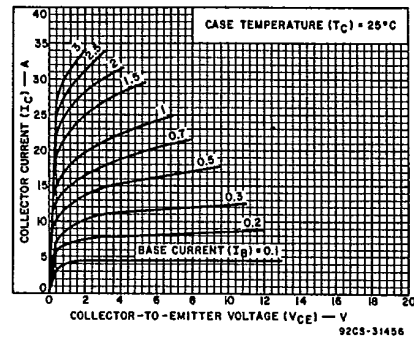

Fig. 7 — Typical output characteristics, 92CS-31456

3875081 G E SOLID STATE
Pro Electron Power Transistors

01E 17611 0 T-33-15

BUX21

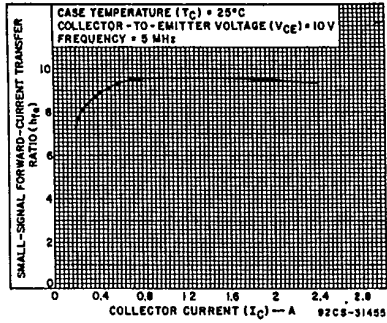

Fig. 8 — Typical small-signal forward-current transfer ratio characteristics.

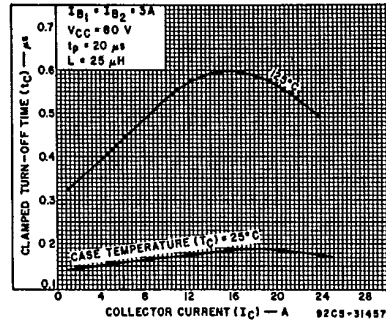

Fig. 9 — Typical clamped turn-off time characteristics.

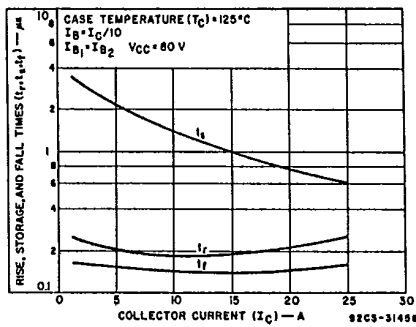

Fig. 10 — Typical saturated-switching-time characteristics as a function of collector current.

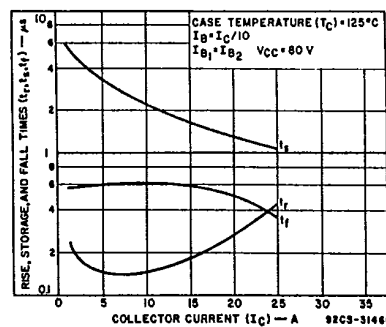

Fig. 11 — Typical-switching-time characteristics at $T_C = 125^\circ C$ as a function of collector current.

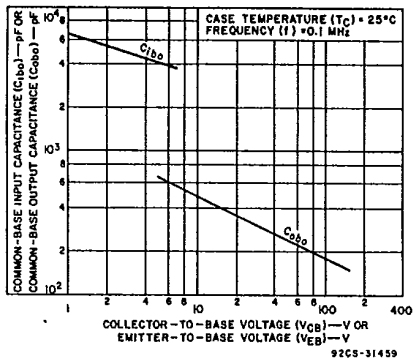

Fig. 12 — Typical common-base input (C_{ib}) or output (C_{ob}) capacitance characteristics.

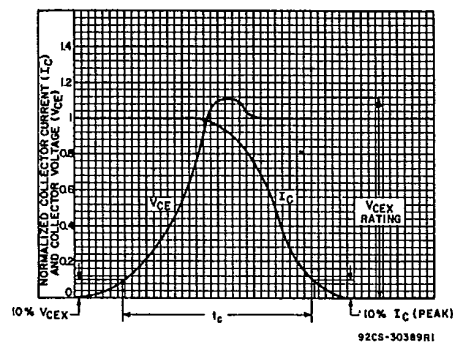

Fig. 13 — Oscilloscope display for normalized measurement of clamped inductive switching time (t_c).

BUX21

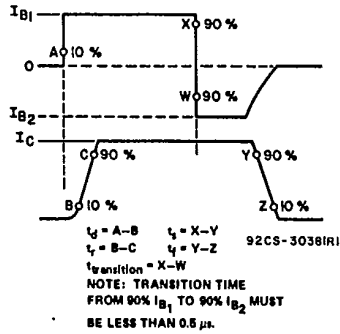

Fig. 14 — Phase relationship between input and output currents showing reference points for specification of switching times.

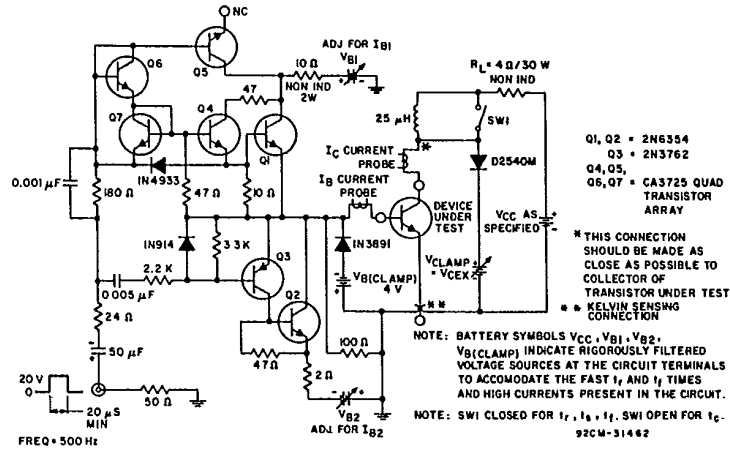

Fig. 15 — Circuit for measuring switching times.