

Main ratings

Drain-source voltage $V_{DS} = 400$ V
 Continuous drain current $I_D = 5$ A
 Drain-source on-resistance $R_{DS(on)} = 1,5 \Omega$

N-Channel

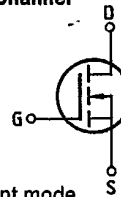

Description FREDFET with fast-recovery reverse diode, N-channel, enhancement mode.
Case Plastic package 14A3 in accordance with DIN 41869, or TO 220 AB in accordance with JEDEC.
 The drain terminal is conductively connected to the mounting flange.
 Approx. weight 2 g

Type	Ordering code
BUZ 206	C67078-A1403-A2

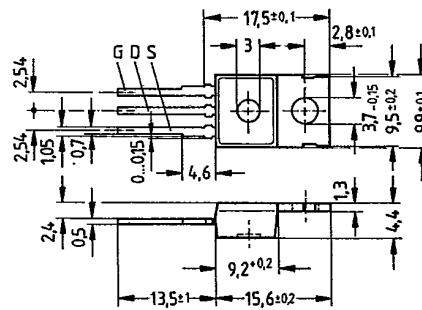

Dimensions in mm

Maximum ratings

Description	Symbols	Ratings	Units	Conditions
Drain-source voltage	V_{DS}	400	V	
Drain-gate voltage	V_{DGR}	400	V	$R_{GS} = 20 \text{ k}\Omega$
Continuous drain current	I_D	5	A	$T_C = 30 \text{ }^\circ\text{C}$
Pulsed drain current	I_{Dpuls}	20	A	$T_C = 25 \text{ }^\circ\text{C}$
Gate-source voltage	V_{GS}	± 20	V	
Max. power dissipation	P_D	75	W	$T_C = 25 \text{ }^\circ\text{C}$
Operating and storage temperature range	T_J T_{stg}	$-55 \dots +150$	$^\circ\text{C}$	
DIN humidity category		E	-	DIN 40040
IEC climatic category		55/150/56	-	DIN IEC 68-1

Thermal resistance

Chip - case	R_{thJC}	$\leq 1,67$	K/W
Chip - ambient	R_{thJA}	≤ 75	K/W

604

1186

A-05

Electrical characteristics

(at $T_j = 25^\circ\text{C}$ unless otherwise specified)

Description	Symbol	Characteristics			Unit	Conditions
		min.	typ.	max.		
Static ratings						
Drain-source breakdown voltage	$V_{(BR)DSS}$	400	—	—	V	$V_{GS} = 0V$ $I_D = 0,25mA$
Gate threshold voltage	$V_{GS(th)}$	2,1	3,0	4,0		$V_{DS} = V_{GS}$ $I_D = 1mA$
Zero gate voltage drain current	I_{DSS}	—	20 100	250 1000	μA	$T_j = 25^\circ\text{C}$ $T_j = 125^\circ\text{C}$ $V_{DS} = 400V$ $V_{GS} = 0V$
Gate-source leakage current	I_{GSS}	—	10	100	nA	$V_{GS} = 20V$ $V_{DS} = 0V$
Drain-source on-resistance	$R_{DS(on)}$	—	1,3	1,5	Ω	$V_{GS} = 10V$ $I_D = 4A$
Dynamic ratings						
Forward transconductance	g_{fs}	1,7	2,9	—	S	$V_{DS} = 25V$ $I_D = 4A$
Input capacitance	C_{iss}	—	1,5	2,0	nF	$V_{GS} = 0V$
Output capacitance	C_{oss}	—	120	180	pF	$V_{DS} = 25V$ $f = 1MHz$
Reverse transfer capacitance	C_{rss}	—	35	60		
Turn-on time t_{on} ($t_{on} = t_{d(on)} + t_r$)	$t_{d(on)}$	—	30	45	ns	$V_{CC} = 30V$ $I_D = 2,6A$ $V_{GS} = 10V$ $R_{GS} = 50\Omega$
	t_r	—	40	60		
Turn-off time t_{off} ($t_{off} = t_{d(off)} + t_f$)	$t_{d(off)}$	—	110	140		
	t_f	—	50	65		
Fast-recovery reverse diode						
Continuous reverse drain current	I_{DR}	—	—	5,0	A	$T_C = 25^\circ\text{C}$
Pulsed reverse drain current	I_{DRM}	—	—	20		
Diode forward on-voltage	V_{SD}	—	1,4	1,8	V	$I_F = 2 \times I_{DR}$ $V_{GS} = 0V, T_j = 25^\circ\text{C}$
Reverse recovery time	t_{rr}	—	180	250	ns	$T_j = 25^\circ\text{C}$ $T_j = 150^\circ\text{C}$ $I_F = I_{DR}$ $df/dt = 100A/\mu s$ $V_R = 100V$
		—	220	300		
Reverse recovery charge	Q_{rr}	—	0,65	1,2	μC	$T_j = 25^\circ\text{C}$ $T_j = 150^\circ\text{C}$
		—	2,6	5,0		
Repetitive peak reverse current	I_{RRM}	—	—	—	A	$T_j = 25^\circ\text{C}$ $T_j = 150^\circ\text{C}$
		—	15	—		

Power dissipation $P_D = f(T_C)$

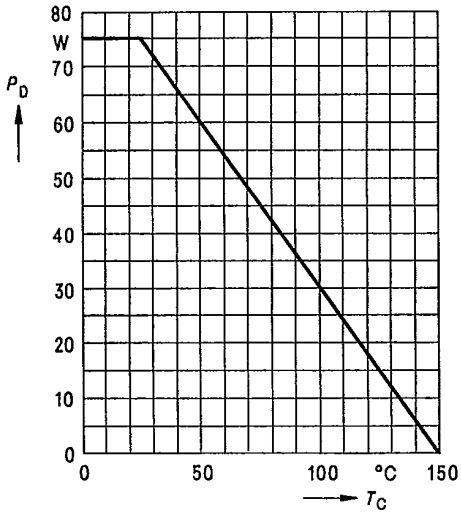

Typical output characteristics $I_D = f(V_{DS})$
 parameter: 80 μ s pulse test,
 $T_j = 25^\circ\text{C}$

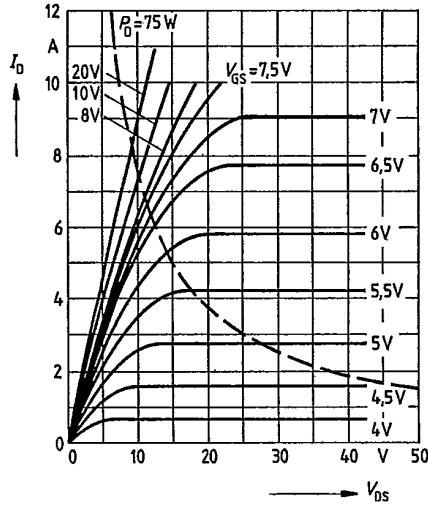

Safe operating area $I_D = f(V_{DS})$
 parameter: $D = 0.01$, $T_C = 25^\circ\text{C}$

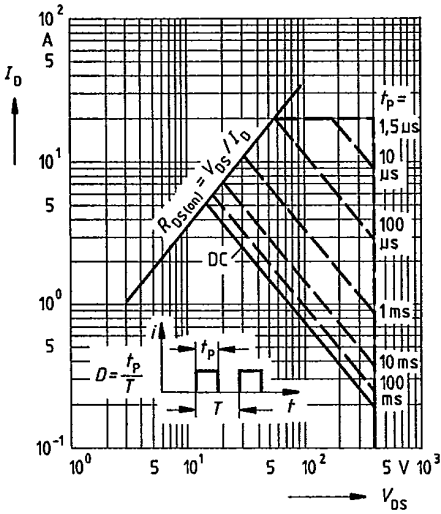

Typical transfer characteristic $I_D = f(V_{GS})$
 parameter: 80 μ s pulse test,
 $V_{DS} = 25\text{V}$, $T_j = 25^\circ\text{C}$

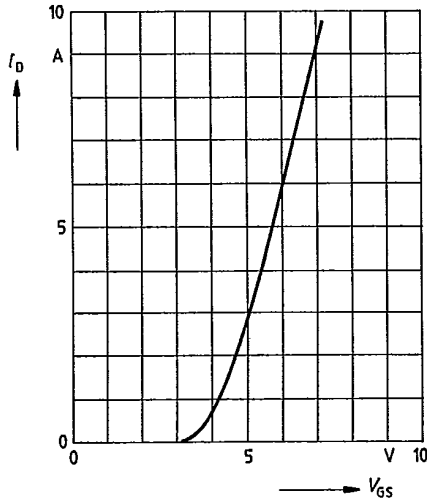

Typical drain-source on-state resistance

$R_{DS(on)} = f(I_D)$
parameter: $V_{GS} = 25V, T_j = 25^\circ C$

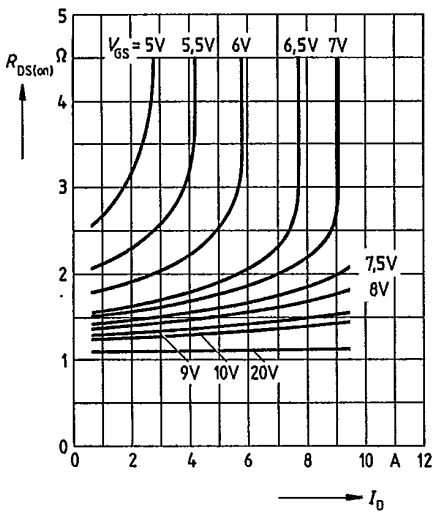

Drain-source on-state resistance

$R_{DS(on)} = f(T_j)$
parameter: $I_D = 4A, V_{GS} = 10V$
(spread)

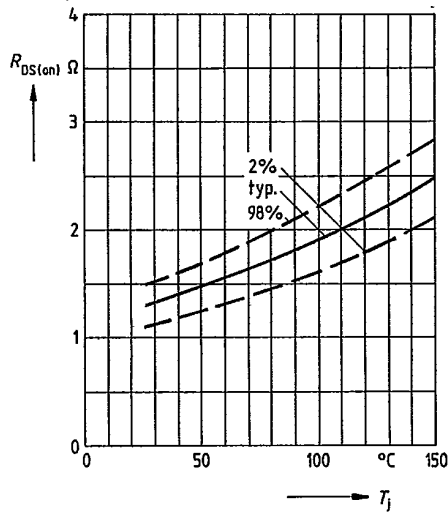

Typical transconductance $g_{fs} = f(I_D)$

parameter: 80 μs pulse test,
 $V_{DS} = 25V, T_j = 25^\circ C$

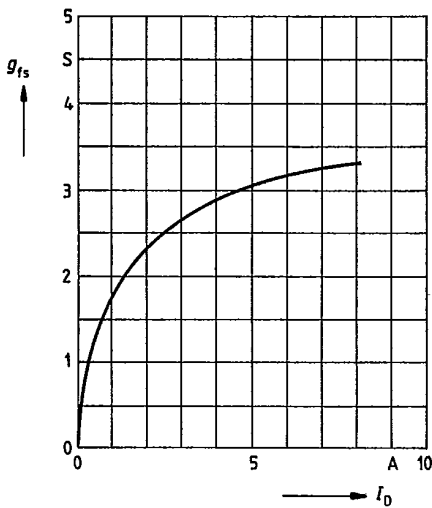

Gate threshold voltage $V_{GS(th)} = f(T_j)$

parameter: $V_{DS} = V_{GS}, I_D = 1mA$
(spread)

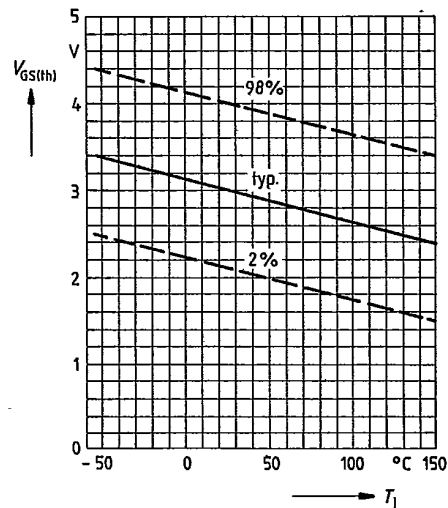

Typical capacitances $C = f(V_{DS})$
 parameter: $V_{GS} = 0, f = 1\text{MHz}$

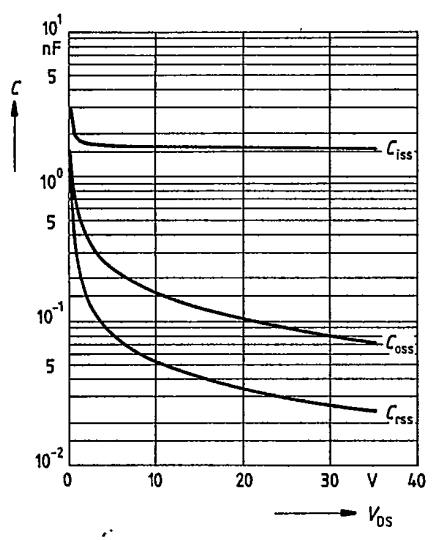

Continuous drain current $I_D = f(T_C)$
 parameter: $V_{GS} \geq 10\text{V}$

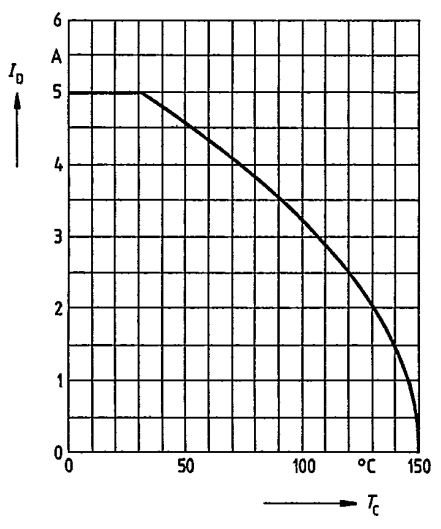

Forward characteristic of reverse diode
 $I_F = f(V_{SD})$
 parameter: $T_j, t_p = 80 \mu\text{s}$
 (spread)

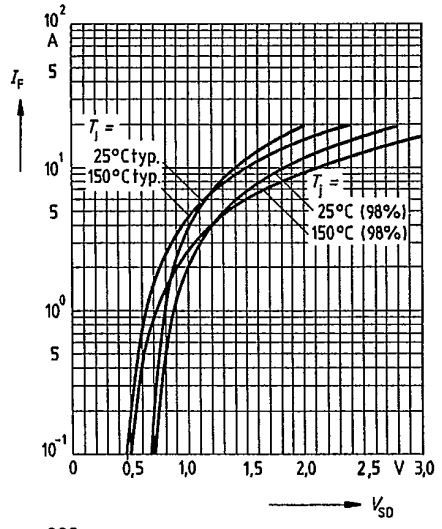

608

1190 A-09

Transient thermal impedance $Z_{thJC} = f(t)$
parameter: $D = t_p/T$

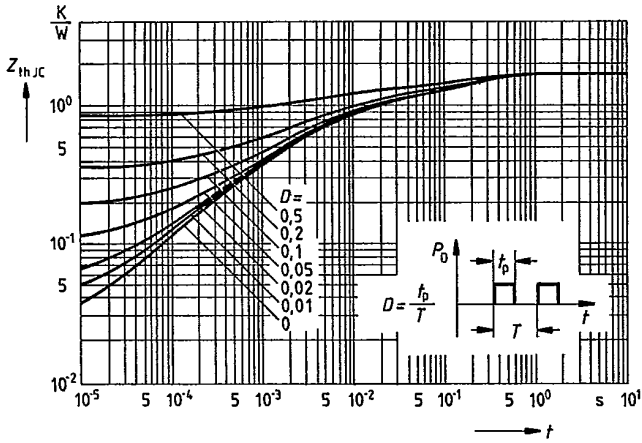

Typical gate-charge $V_{GS} = f(Q_{Gate})$
parameter: $I_D \text{ puls} = 8,3A$

