

SIEMENS AKTIENGESELLSCHAFT

Main ratings

Drain-source voltage  $V_{DS} = 500\text{ V}$   
 Continuous drain current  $I_D = 4,4\text{ A}$   
 Drain-source on-resistance  $R_{DS(on)} = 2\ \Omega$

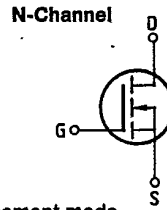

**Description** FREDFET with fast-recovery reverse diode, N-channel, enhancement mode.  
**Case** Plastic package 14 A 3 in accordance with DIN 41869, or TO 220 AB in accordance with JEDEC. The drain terminal is conductively connected to the mounting flange. Approx. weight 2 g

Type	Ordering code
BUZ 216	C67078-A1402-A2

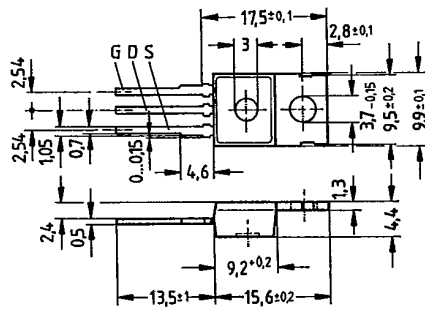

Dimensions in mm

Maximum ratings

Description	Symbols	Ratings	Units	Conditions
Drain-source voltage	$V_{DS}$	500	V	
Drain-gate voltage	$V_{DGR}$	500	V	$R_{GS} = 20\text{ k}\Omega$
Continuous drain current	$I_D$	4,4	A	$T_C = 25\text{ }^\circ\text{C}$
Pulsed drain current	$I_{D(puls)}$	17	A	$T_C = 25\text{ }^\circ\text{C}$
Gate-source voltage	$V_{GS}$	$\pm 20$	V	
Max. power dissipation	$P_D$	75	W	$T_C = 25\text{ }^\circ\text{C}$
Operating and storage temperature range	$T_j$ $T_{stg}$	$-55 \dots +150$	$^\circ\text{C}$	
DIN humidity category		E	-	DIN 40040
IEC climatic category		55/150/56	-	DIN IEC 68-1

Thermal resistance

Chip - case	$R_{thJC}$	$\leq 1,67$	K/W
Chip - ambient	$R_{thJA}$	$\leq 75$	K/W

**Electrical characteristics**(at  $T_j = 25^\circ\text{C}$  unless otherwise specified)

Description	Symbol	Characteristics			Unit	Conditions
		min.	typ.	max.		
<b>Static ratings</b>						
Drain-source breakdown voltage	$V_{(BR)DSS}$	500	—	—	V	$V_{GS} = 0V$ $I_D = 0,25mA$
Gate threshold voltage	$V_{GS(th)}$	2,1	3,0	4,0		$V_{DS} = V_{GS}$ $I_D = 1mA$
Zero gate voltage drain current	$I_{DSS}$	—	20	250	$\mu A$	$T_j = 25^\circ\text{C}$ $T_j = 125^\circ\text{C}$ $V_{DS} = 500V$ $V_{GS} = 0V$
Gate-source leakage current	$I_{GSS}$	—	10	100	nA	$V_{GS} = 20V$ $V_{DS} = 0V$
Drain-source on-resistance	$R_{DS(on)}$	—	1,7	2,0	$\Omega$	$V_{GS} = 10V$ $I_D = 3,2A$
<b>Dynamic ratings</b>						
Forward transconductance	$g_{fs}$	1,5	2,7	—	S	$V_{DS} = 25V$ $I_D = 3,2A$
Input capacitance	$C_{iss}$	—	1,5	2,0	nF	$V_{GS} = 0V$ $V_{DS} = 25V$ $f = 1MHz$
Output capacitance	$C_{oss}$	—	110	170	pF	
Reverse transfer capacitance	$C_{rss}$	—	40	70		
Turn-on time $t_{on}$ ( $t_{on} = t_{d(on)} + t_r$ )	$t_{d(on)}$	—	30	45	ns	$V_{CC} = 30V$ $I_D = 2,5A$ $V_{GS} = 10V$ $R_{GS} = 50\Omega$
	$t_r$	—	40	60		
Turn-off time $t_{off}$ ( $t_{off} = t_{d(off)} + t_f$ )	$t_{d(off)}$	—	110	140		
	$t_f$	—	50	65		
<b>Fast-recovery reverse diode</b>						
Continuous reverse drain current	$I_{DR}$	—	—	4,4	A	$T_C = 25^\circ\text{C}$
Pulsed reverse drain current	$I_{DRM}$	—	—	17		
Diode forward on-voltage	$V_{SD}$	—	1,3	1,6	V	$I_F = 2 \times I_{DR}$ $V_{GS} = 0V, T_j = 25^\circ\text{C}$
Reverse recovery time	$t_{rr}$	—	180	250	ns	$T_j = 25^\circ\text{C}$ $T_j = 150^\circ\text{C}$ $I_F = I_{DR}$ $di/dt = 100A/\mu s$ $V_R = 100V$
Reverse recovery charge	$Q_{rr}$	—	0,65	1,2		
Repetitive peak reverse current	$I_{RRM}$	—	—	—	A	$T_j = 25^\circ\text{C}$ $T_j = 150^\circ\text{C}$
		—	15	—		

Power dissipation  $P_D = f(T_C)$

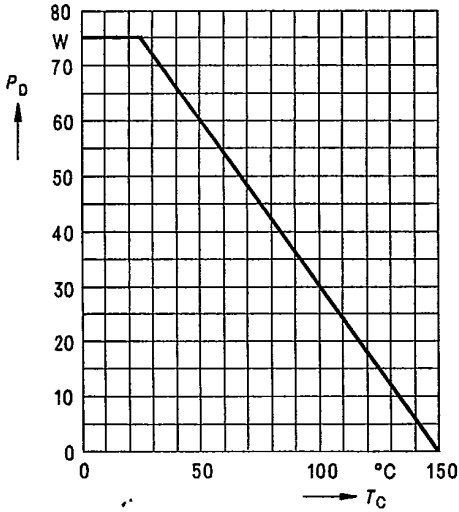

Typical output characteristics  $I_D = f(V_{DS})$   
parameter: 80  $\mu$ s pulse test,  
 $T_j = 25^\circ\text{C}$

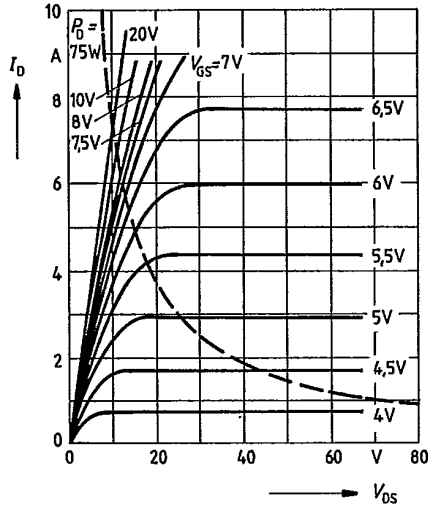

Safe operating area  $I_D = f(V_{DS})$   
parameter:  $D = 0.01$ ,  $T_C = 25^\circ\text{C}$

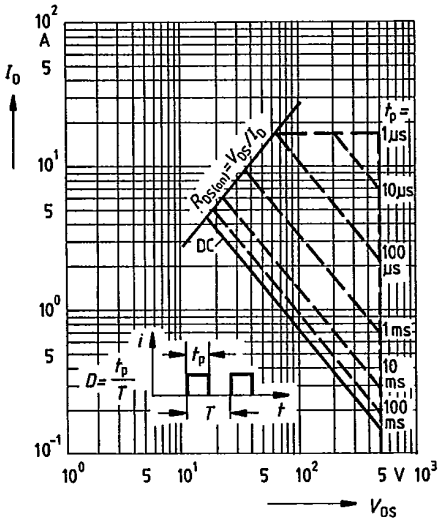

Typical transfer characteristic  $I_D = f(V_{GS})$   
parameter: 80  $\mu$ s pulse test,  
 $V_{DS} = 25\text{V}$ ,  $T_j = 25^\circ\text{C}$

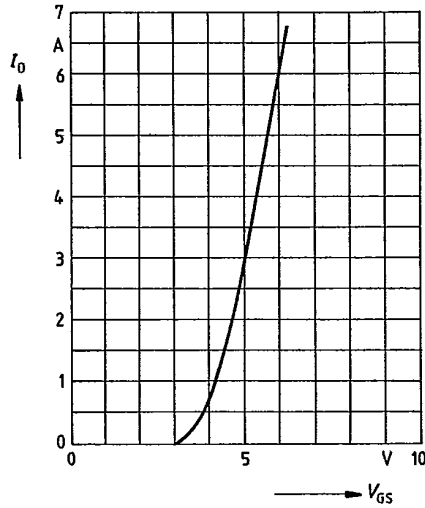

SIEMENS AKTIENGESELLSCHAFT

Typical drain-source on-state resistance

$R_{DS(on)} = f(I_D)$   
parameter:  $V_{GS} = 10V$ ,  $T_j = 25^\circ C$

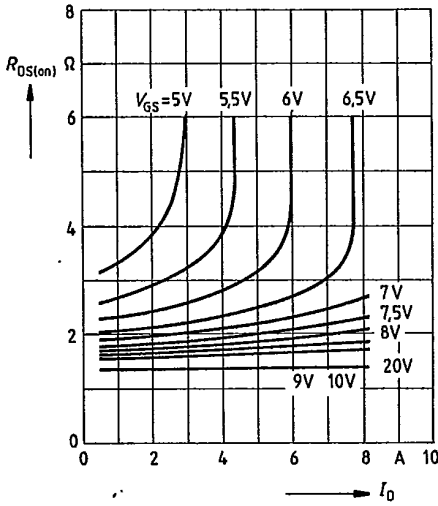

Drain-source on-state resistance

$R_{DS(on)} = f(T_j)$   
parameter:  $I_D = 3.2A$ ,  $V_{GS} = 10V$   
(spread)

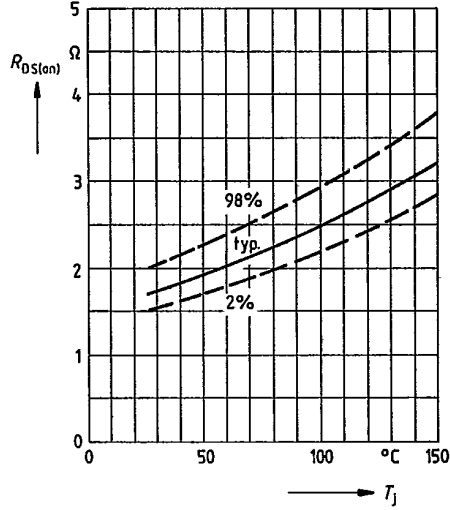

Typical transconductance  $g_{fs} = f(I_D)$

parameter: 80  $\mu s$  pulse test,  
 $V_{DS} = 25V$ ,  $T_j = 25^\circ C$

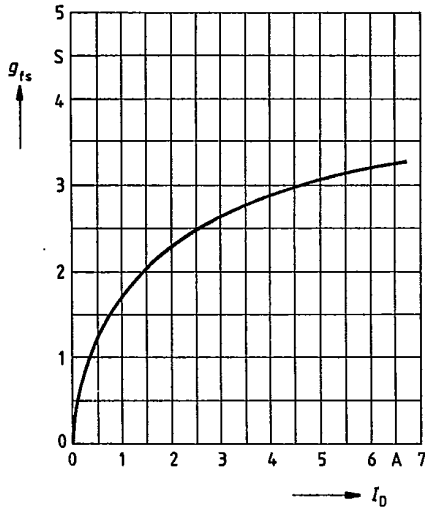

Gate threshold voltage  $V_{GS(th)} = f(T_j)$

parameter:  $V_{DS} = V_{GS}$ ,  $I_D = 1mA$   
(spread)

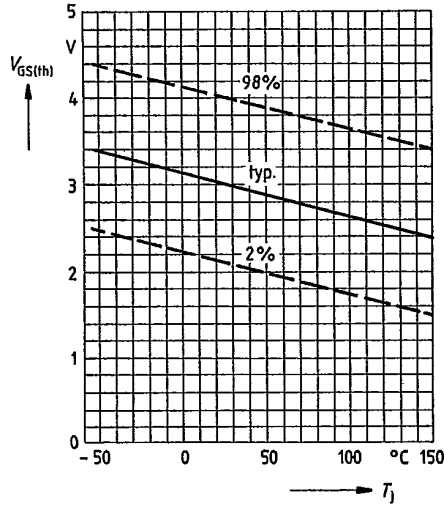

Typical capacitances  $C = f(V_{GS})$   
parameter:  $V_{GS} = 0, f = 1\text{MHz}$

Continuous drain current  $I_D = f(T_C)$   
parameter:  $V_{GS} \geq 10\text{V}$

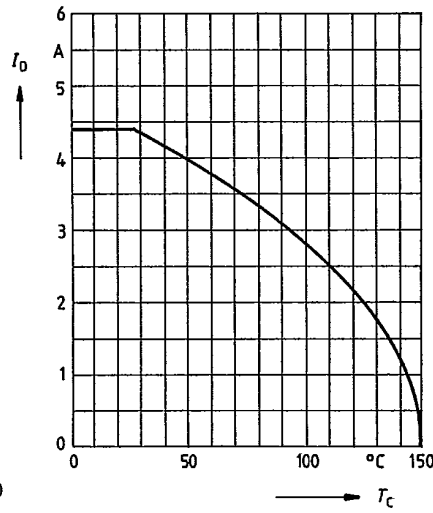
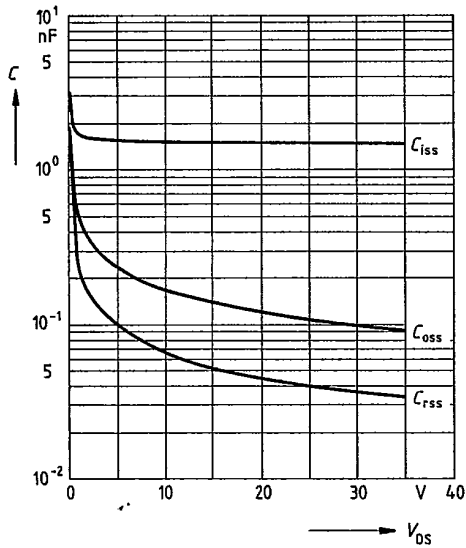

Forward characteristic of reverse diode

$I_F = f(V_{SD})$   
parameter:  $T_j, t_p = 80 \mu\text{s}$   
(spread)

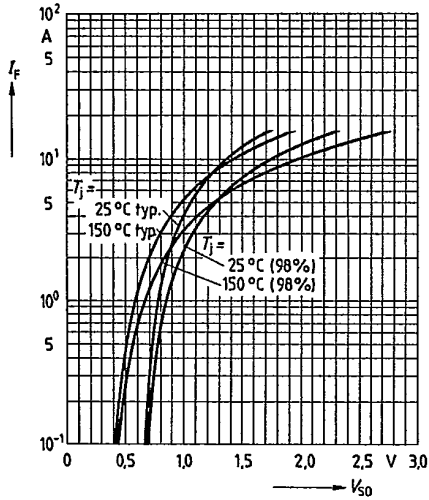

— SIEMENS AKTIENGESELLSCHAFT —

Transient thermal impedance  $Z_{thJC} = f(t)$   
 parameter:  $D = t_p/T$

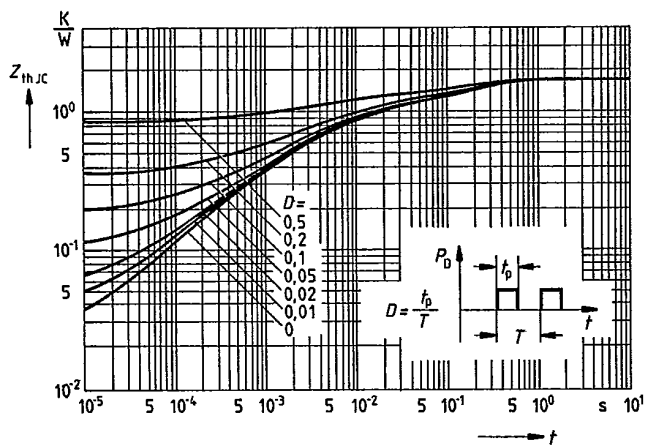

Typical gate-charge  $V_{GS} = f(Q_{Gate})$   
 parameter:  $I_{D\ puls} = 6.8A$

