

SIEMENS AKTIENGESELLSCHAFT

Main ratings

Drain-source voltage $V_{DS} = 100\text{ V}$
 Continuous drain current $I_D = 10\text{ A}$
 Drain-source on-resistance $R_{DS(on)} = 0,2\ \Omega$

N-Channel

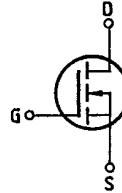

Description SIPMOS, N-channel, enhancement mode
 Case Metal case 3A2 in accordance with DIN 41872, or TO 204 AA (TO 3) in accordance with JEDEC.
 Approx. weight 12 g

Type	Ordering code
BUZ 23	C67078-A1002-A2

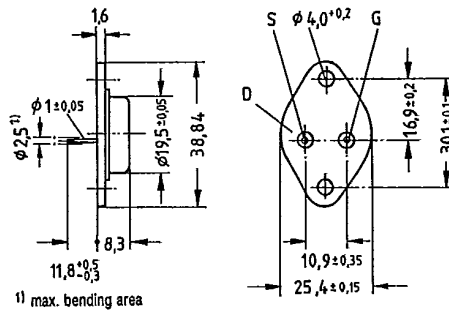

Dimensions in mm

Maximum ratings

Description	Symbols	Ratings	Units	Conditions
Drain-source voltage	V_{DS}	100	V	
Drain-gate voltage	V_{DGR}	100	V	$R_{GS} = 20\text{ k}\Omega$
Continuous drain current	I_D	10	A	$T_C = 85\text{ }^\circ\text{C}$
Pulsed drain current	$I_{D,puls}$	40	A	$T_C = 25\text{ }^\circ\text{C}$
Gate-source voltage	V_{GS}	± 20	V	
Max. power dissipation	P_D	78	W	$T_C = 25\text{ }^\circ\text{C}$
Operating and storage temperature range	T_j T_{stg}	$-55 \dots +150$	$^\circ\text{C}$	
DIN humidity category	C			DIN 40040
IEC climatic category		55/150/56		DIN IEC 68-1

Thermal resistance

Chip - case	$R_{th,jc}$	$\leq 1,6$	K/W
Chip - ambient	$R_{th,ja}$	≤ 35	K/W

220 Preferred Type

0802

A-13

SIEMENS AKTIENGESELLSCHAFT

Electrical characteristics(at $T_j = 25^\circ\text{C}$ unless otherwise specified)

Description	Symbol	Characteristics			Unit	Conditions
		min.	typ.	max.		

Static ratings

Drain-source breakdown voltage	$V_{(BR)DSS}$	100	—	—	V	$V_{GS} = 0V$ $I_D = 0,25mA$
Gate threshold voltage	$V_{GS(th)}$	2,1	3,0	4,0		$V_{DS} = V_{GS}$ $I_D = 1mA$
Zero gate voltage drain current	I_{DSS}	—	20	250	μA	$T_j = 25^\circ C$ $T_j = 125^\circ C$ $V_{DS} = 100V$ $V_{GS} = 0V$
Gate-source leakage current	I_{GSS}	—	10	100	nA	$V_{GS} = 20V$ $V_{DS} = 0V$
Drain-source on-resistance	$R_{DS(on)}$	—	0,15	0,2	Ω	$V_{GS} = 10V$ $I_D = 6A$

Dynamic ratings

Forward transconductance	g_{fs}	2,7	4,0	—	S	$V_{DS} = 25V$ $I_D = 6A$
Input capacitance	C_{iss}	—	1500	2000	pF	$V_{GS} = 0V$ $V_{DS} = 25V$ $f = 1MHz$
Output capacitance	C_{oss}	—	300	500		
Reverse transfer capacitance	C_{rss}	—	80	140		
Turn-on time t_{on} ($t_{on} = t_{d(on)} + t_r$)	$t_{d(on)}$	—	30	45	ns	$V_{CC} = 30V$ $I_D = 2,9A$ $V_{GS} = 10V$ $R_{GS} = 50\Omega$
	t_r	—	50	75		
Turn-off time t_{off} ($t_{off} = t_{d(off)} + t_f$)	$t_{d(off)}$	—	110	140	ns	
	t_f	—	60	80		

Reverse diode

Continuous reverse drain current	I_{DR}	—	—	10	A	$T_C = 25^\circ C$
Pulsed reverse drain current	I_{DRM}	—	—	40		
Diode forward on-voltage	V_{SD}	—	1,3	1,6	V	$I_F = 2 \times I_{DR}$ $V_{GS} = 0V, T_j = 25^\circ C$
Reverse recovery time	t_{rr}	—	200	—	ns	$T_j = 25^\circ C$
Reverse recovery charge	Q_{rr}	—	1,6	—	μC	$I_F = I_{DR}$ $d_{F/dt} = 100A/\mu s$ $V_R = 30V$

SIEMENS AKTIENGESELLSCHAFT

Power dissipation $P_D = f(T_C)$

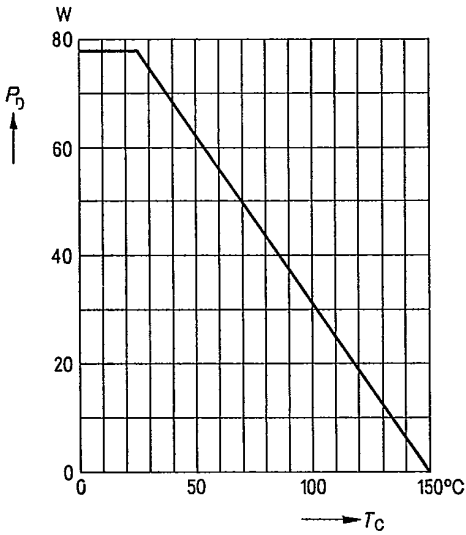

Typical output characteristics $I_D = f(V_{DS})$
 parameter: 80 μ s pulse test,
 $T_I = 25^\circ\text{C}$

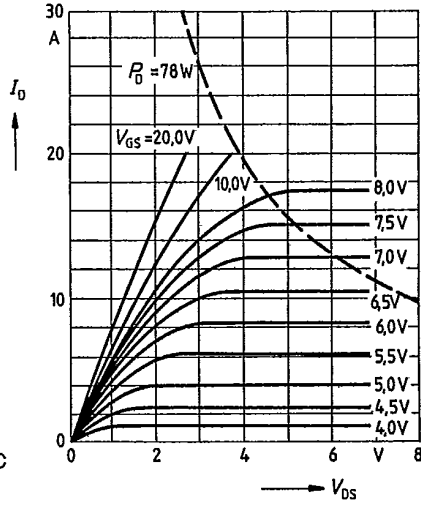

Safe operating area $I_D = f(V_{DS})$
 parameter: $D = 0.01$, $T_C = 25^\circ\text{C}$

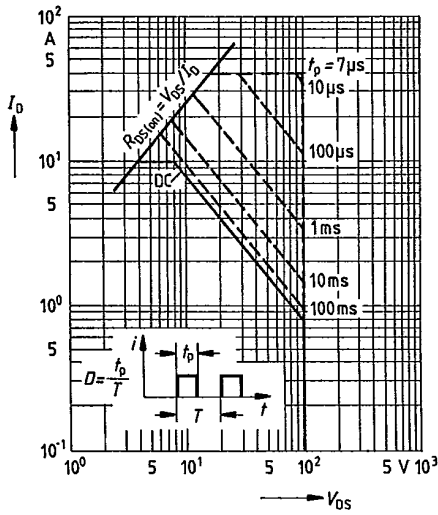

Typical transfer characteristic $I_D = f(V_{GS})$
 parameter: 80 μ s pulse test,
 $V_{DS} = 25\text{V}$, $T_I = 25^\circ\text{C}$

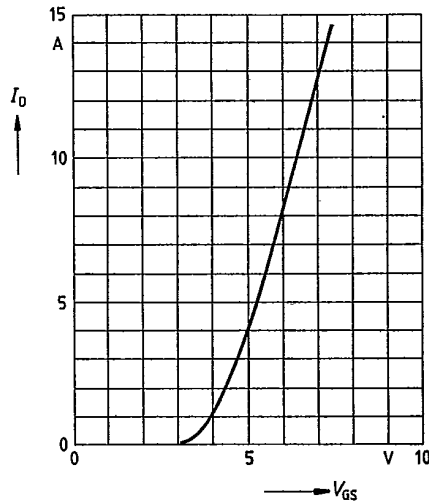

SIEMENS AKTIENGESELLSCHAFT

Typical drain-source on-state resistance

$R_{DS(on)} = f(I_D)$
parameter: $V_{GS} = 10V, T_j = 25^\circ C$

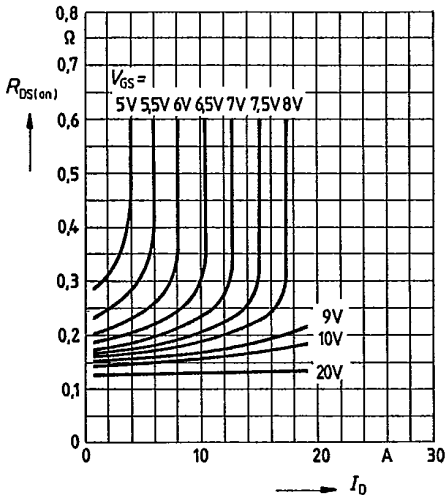

Drain-source on-state resistance

$R_{DS(on)} = f(T_j)$
parameter: $I_D = 6A, V_{GS} = 10V$
(spread)

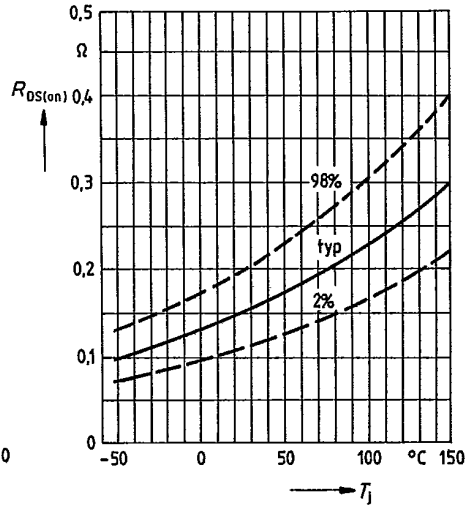

Typical transconductance $g_{fs} = f(I_D)$

parameter: 80 μs pulse test,
 $V_{DS} = 25V, T_j = 25^\circ C$

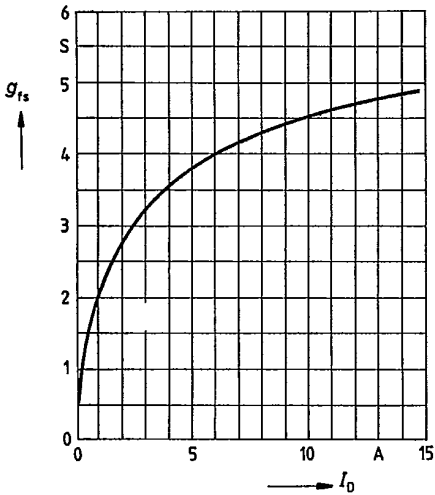

Gate threshold voltage $V_{GS(th)} = f(T_j)$

parameter: $V_{DS} = V_{GS}, I_D = 1mA$
(spread)

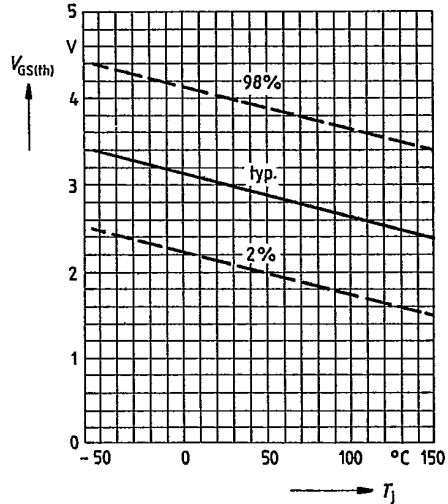

SIEMENS AKTIENGESELLSCHAFT

Typical capacitances $C = f(V_{GS})$
 parameter: $V_{GS} = 0, f = 1\text{MHz}$

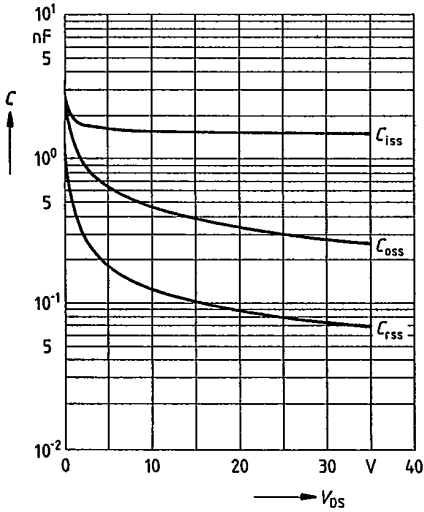

Continuous drain current $I_D = f(T_C)$
 parameter: $V_{GS} \geq 10\text{V}$

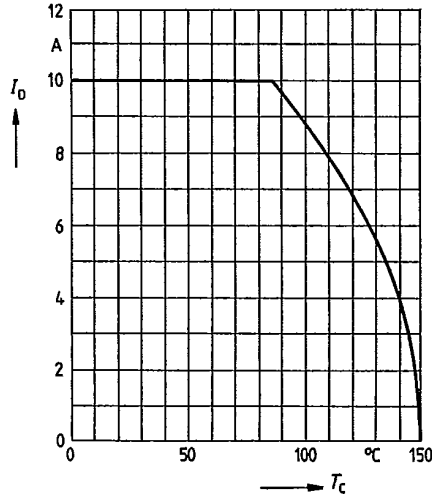

Forward characteristic of reverse diode

$I_F = f(V_{SD})$
 parameter: $T_j, t_p = 80 \mu\text{s}$
 (spread)

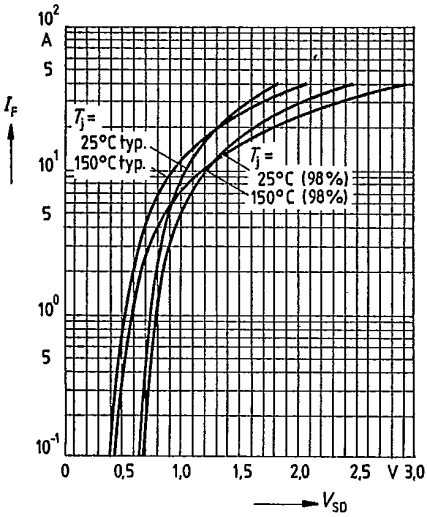

SIEMENS AKTIENGESELLSCHAFT

Transient thermal impedance $Z_{thJC} = f(t)$
 parameter: $D = t_p/T$

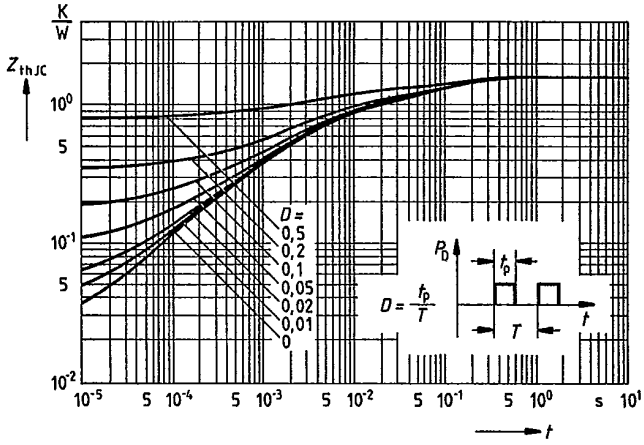

Typical gate-charge $V_{GS} = f(Q_{Gate})$
 parameter: $I_{D\ puls} = 18A$

