

## SIPMOS® Power Transistor

- N channel
- Enhancement mode
- FREDFET

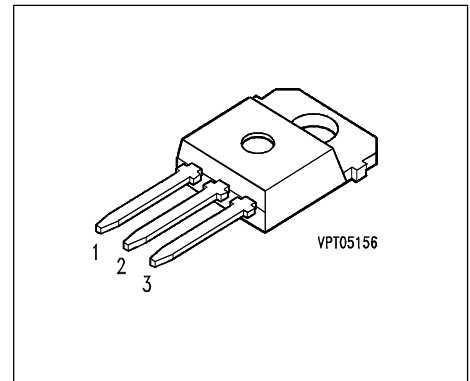

Pin 1	Pin 2	Pin 3
G	D	S

Type	$V_{DS}$	$I_D$	$R_{DS(on)}$	Package	Ordering Code
BUZ 382	400 V	12.5 A	0.4 $\Omega$	TO-218 AA	C67078-A3207-A2

### Maximum Ratings

Parameter	Symbol	Values	Unit
Drain source voltage	$V_{DS}$	400	V
Drain-gate voltage $R_{GS} = 20 \text{ k}\Omega$	$V_{DGR}$	400	
Continuous drain current $T_C = 30 \text{ }^\circ\text{C}$	$I_D$	12.5	A
Pulsed drain current $T_C = 25 \text{ }^\circ\text{C}$	$I_{Dpuls}$	50	
Gate source voltage	$V_{GS}$	$\pm 20$	V
Power dissipation $T_C = 25 \text{ }^\circ\text{C}$	$P_{tot}$	125	W
Operating temperature	$T_j$	-55 ... + 150	$^\circ\text{C}$
Storage temperature	$T_{stg}$	-55 ... + 150	
Thermal resistance, chip case	$R_{thJC}$	$\leq 1$	K/W
Thermal resistance, chip to ambient	$R_{thJA}$	75	
DIN humidity category, DIN 40 040		E	
IEC climatic category, DIN IEC 68-1		55 / 150 / 56	

**Electrical Characteristics, at  $T_j = 25^\circ\text{C}$ , unless otherwise specified**

Parameter	Symbol	Values			Unit
		min.	typ.	max.	
<b>Static Characteristics</b>					
Drain- source breakdown voltage $V_{GS} = 0\text{ V}, I_D = 0.25\text{ mA}, T_j = 25\text{ }^\circ\text{C}$	$V_{(BR)DSS}$	400	-	-	V
Gate threshold voltage $V_{GS}=V_{DS}, I_D = 1\text{ mA}$	$V_{GS(th)}$	2.1	3.5	4	
Zero gate voltage drain current $V_{DS} = 400\text{ V}, V_{GS} = 0\text{ V}, T_j = 25\text{ }^\circ\text{C}$ $V_{DS} = 400\text{ V}, V_{GS} = 0\text{ V}, T_j = 125\text{ }^\circ\text{C}$	$I_{DSS}$	-	20 100	250 1000	$\mu\text{A}$
Gate-source leakage current $V_{GS} = 20\text{ V}, V_{DS} = 0\text{ V}$	$I_{GSS}$	-	10	100	nA
Drain-Source on-resistance $V_{GS} = 10\text{ V}, I_D = 8\text{ A}$	$R_{DS(on)}$	-	0.35	0.4	$\Omega$

**Electrical Characteristics, at  $T_j = 25^\circ\text{C}$ , unless otherwise specified**

Parameter	Symbol	Values			Unit
		min.	typ.	max.	
<b>Dynamic Characteristics</b>					
Transconductance $V_{DS} \geq 2 \cdot I_D \cdot R_{DS(on)max}, I_D = 8 \text{ A}$	$g_{fs}$	3.3	6.2	-	S
Input capacitance $V_{GS} = 0 \text{ V}, V_{DS} = 25 \text{ V}, f = 1 \text{ MHz}$	$C_{iss}$	-	3800	4900	pF
Output capacitance $V_{GS} = 0 \text{ V}, V_{DS} = 25 \text{ V}, f = 1 \text{ MHz}$	$C_{oss}$	-	300	500	
Reverse transfer capacitance $V_{GS} = 0 \text{ V}, V_{DS} = 25 \text{ V}, f = 1 \text{ MHz}$	$C_{rss}$	-	120	200	
Turn-on delay time $V_{DD} = 30 \text{ V}, V_{GS} = 10 \text{ V}, I_D = 2.9 \text{ A}$ $R_{GS} = 50 \Omega$	$t_{d(on)}$	-	50	75	ns
Rise time $V_{DD} = 30 \text{ V}, V_{GS} = 10 \text{ V}, I_D = 2.9 \text{ A}$ $R_{GS} = 50 \Omega$	$t_r$	-	80	120	
Turn-off delay time $V_{DD} = 30 \text{ V}, V_{GS} = 10 \text{ V}, I_D = 2.9 \text{ A}$ $R_{GS} = 50 \Omega$	$t_{d(off)}$	-	330	430	
Fall time $V_{DD} = 30 \text{ V}, V_{GS} = 10 \text{ V}, I_D = 2.9 \text{ A}$ $R_{GS} = 50 \Omega$	$t_f$	-	110	140	

**Electrical Characteristics, at  $T_j = 25^\circ\text{C}$ , unless otherwise specified**

Parameter	Symbol	Values			Unit
		min.	typ.	max.	
<b>Reverse Diode</b>					
Inverse diode continuous forward current $T_C = 25^\circ\text{C}$	$I_S$	-	-	12.5	A
Inverse diode direct current, pulsed $T_C = 25^\circ\text{C}$	$I_{SM}$	-	-	50	
Inverse diode forward voltage $V_{GS} = 0\text{ V}, I_F = 25\text{ A}$	$V_{SD}$	-	1.3	1.7	V
Reverse recovery time $V_R = 100\text{ V}, I_F = I_S, di_F/dt = 100\text{ A}/\mu\text{s}$	$t_{rr}$	-	180	250	ns
Reverse recovery charge $V_R = 100\text{ V}, I_F = I_S, di_F/dt = 100\text{ A}/\mu\text{s}$	$Q_{rr}$	-	0.65	1.2	$\mu\text{C}$

### Power dissipation

$$P_{\text{tot}} = f(T_C)$$



### Drain current

$$I_D = f(T_C)$$

parameter:  $V_{GS} \geq 10 \text{ V}$

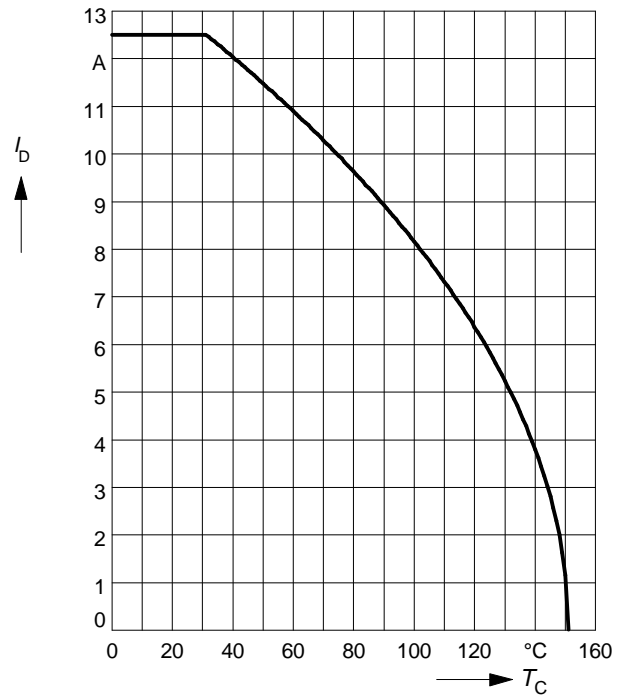

### Safe operating area

$$I_D = f(V_{DS})$$

parameter:  $D = 0.01, T_C = 25^\circ\text{C}$

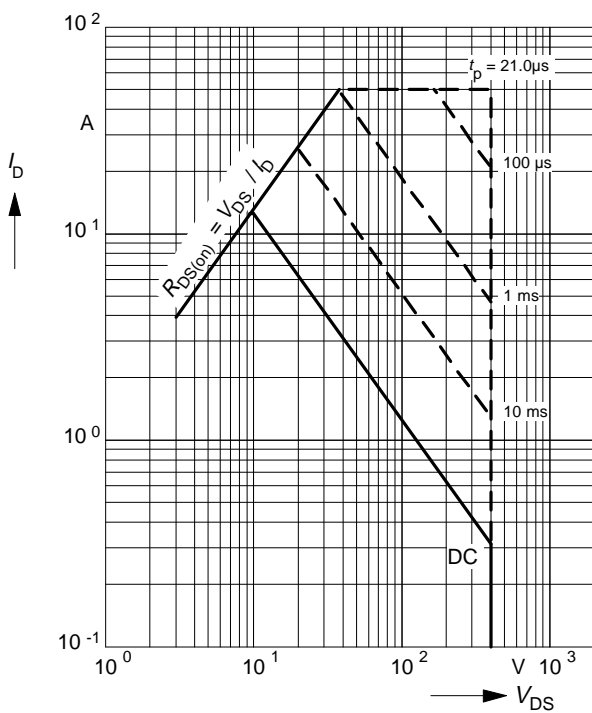

### Transient thermal impedance

$$Z_{\text{th JC}} = f(t_p)$$

parameter:  $D = t_p / T$

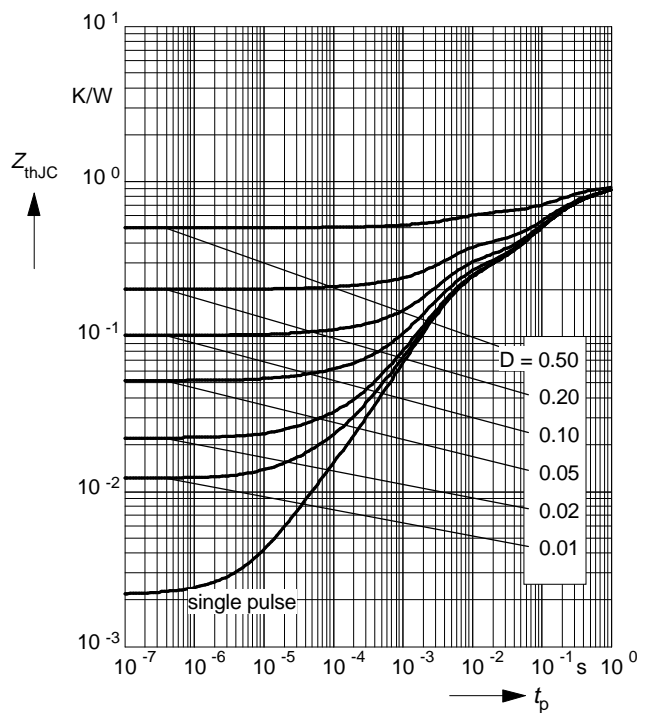

### Typ. output characteristics

$$I_D = f(V_{DS})$$

parameter:  $t_p = 80 \mu s$

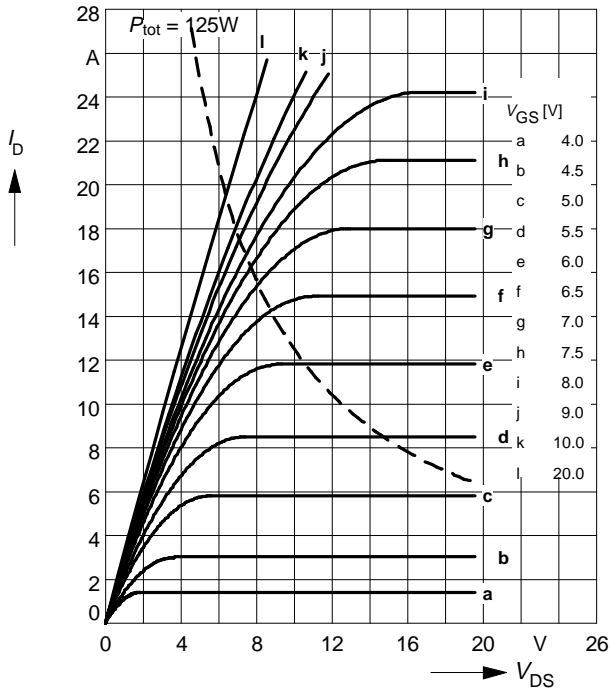

### Typ. drain-source on-resistance

$$R_{DS(on)} = f(I_D)$$

parameter:  $V_{GS}$

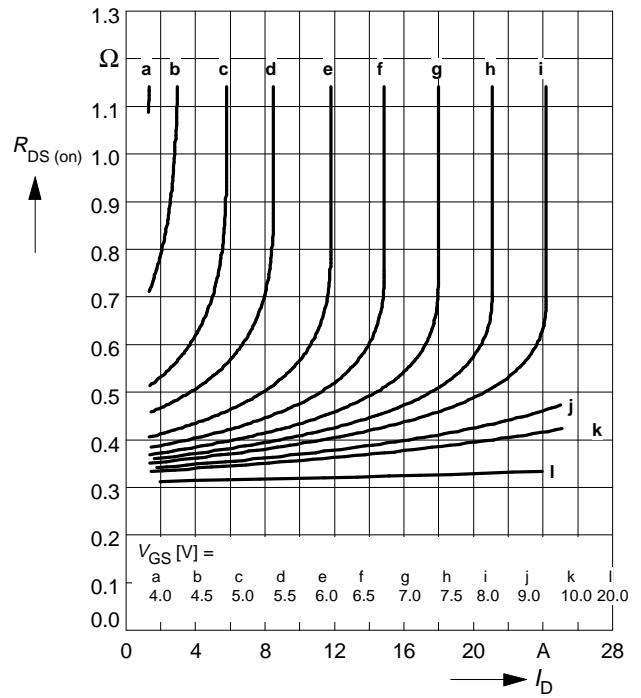

### Typ. transfer characteristics $I_D = f(V_{GS})$

parameter:  $t_p = 80 \mu s$

$$V_{DS} \geq 2 \times I_D \times R_{DS(on)max}$$

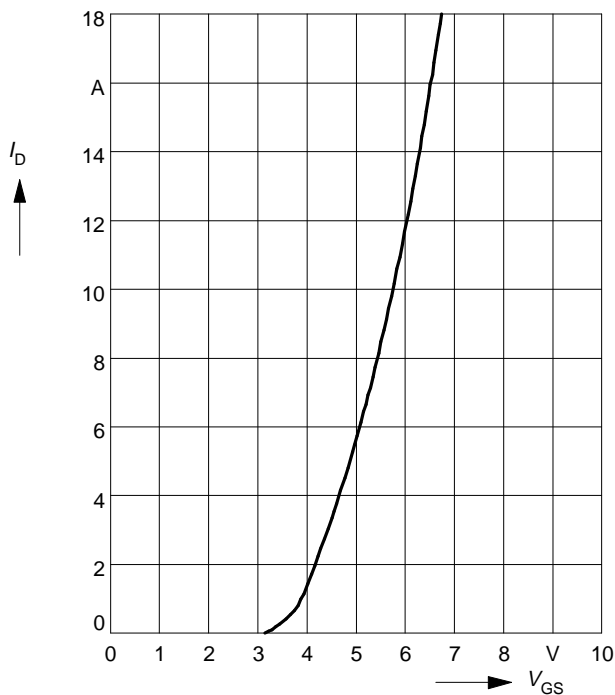

### Typ. forward transconductance $g_{fs} = f(I_D)$

parameter:  $t_p = 80 \mu s$ ,

$$V_{DS} \geq 2 \times I_D \times R_{DS(on)max}$$

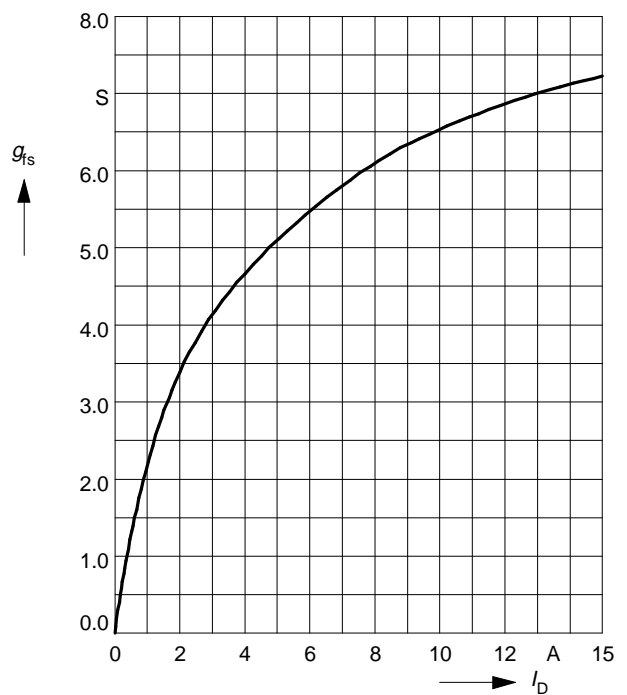

### Drain-source on-resistance

$$R_{DS(on)} = f(T_j)$$

parameter:  $I_D = 8\text{ A}$ ,  $V_{GS} = 10\text{ V}$

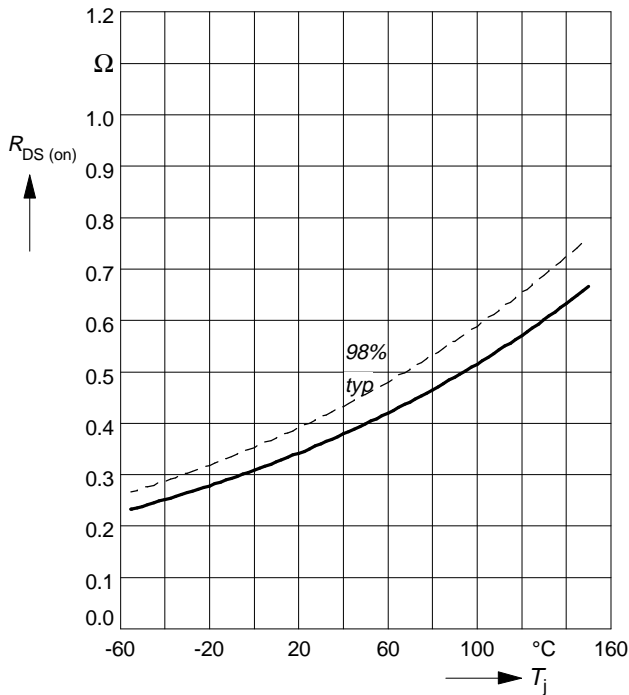

### Gate threshold voltage

$$V_{GS(th)} = f(T_j)$$

parameter:  $V_{GS} = V_{DS}$ ,  $I_D = 1\text{ mA}$

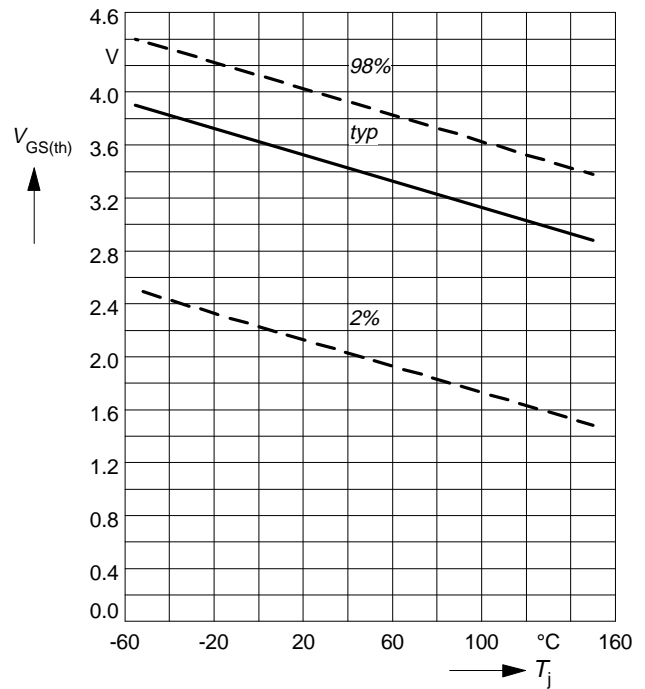

### Typ. capacitances

$$C = f(V_{DS})$$

parameter:  $V_{GS} = 0\text{ V}$ ,  $f = 1\text{ MHz}$

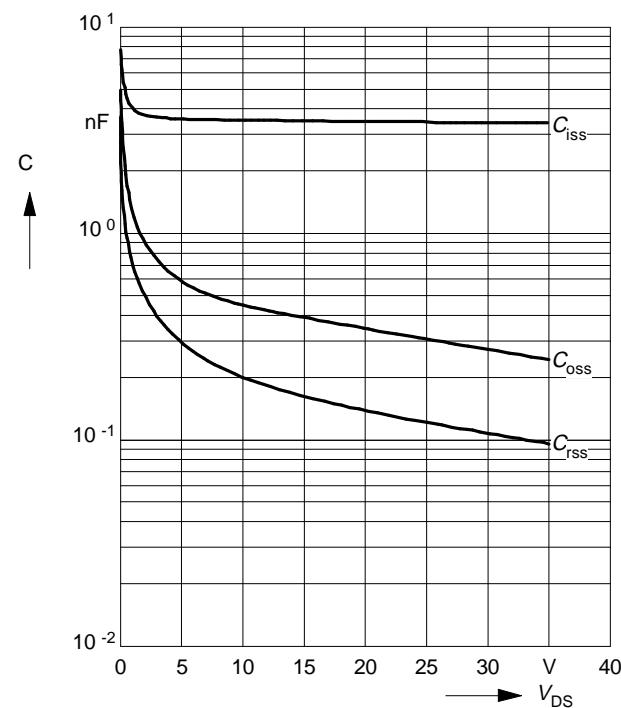

### Forward characteristics of reverse diode

$$I_F = f(V_{SD})$$

parameter:  $T_j$ ,  $t_p = 80\text{ }\mu\text{s}$

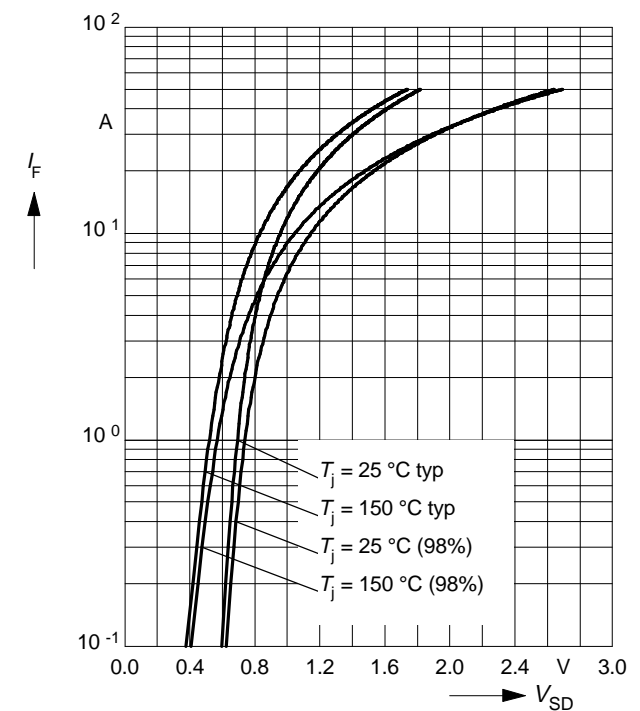

### Drain-source breakdown voltage

$$V_{(BR)DSS} = f(T_j)$$

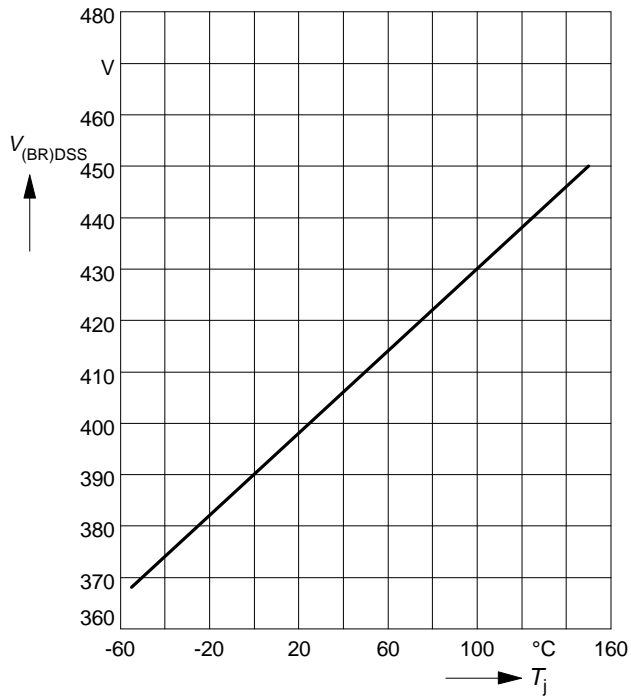

### Typ. gate charge

$$V_{GS} = f(Q_{Gate})$$

parameter:  $I_{D\ puls} = 17\ A$

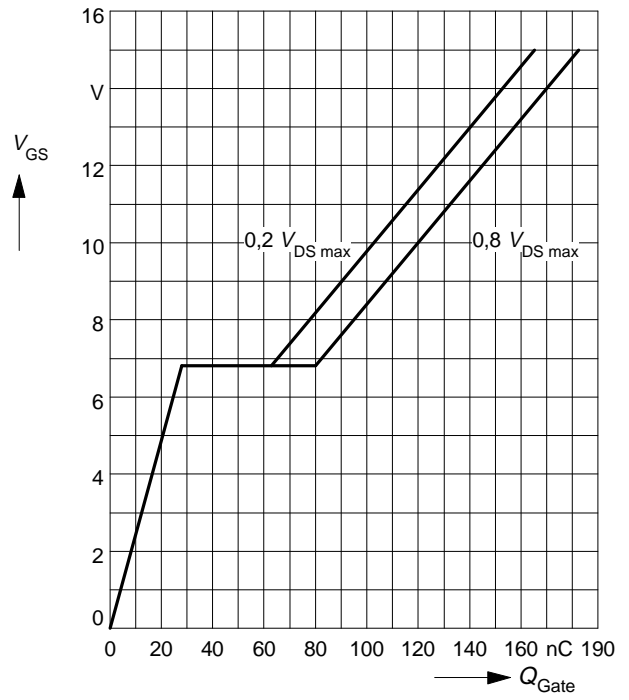



## Package Outlines

TO-218 AA

Dimension in mm



- 1) punch direction, burr max. 0.04
- 2) dip tinning
- 3) max. 15.5 by dip tinning press burr max. 0.05