



**BVU-359QT9**

**DESCRIPTION**

Dice Material : AllnGaP/GaP Orange Red  
 Light Color : Orange Red Color  
 Lens Color : Red Tinted Diffused  
 Stand-Off P/N : BVU-359QT9 R  
 Lead Frame Material: Copper

**RADIATION PATTERN**

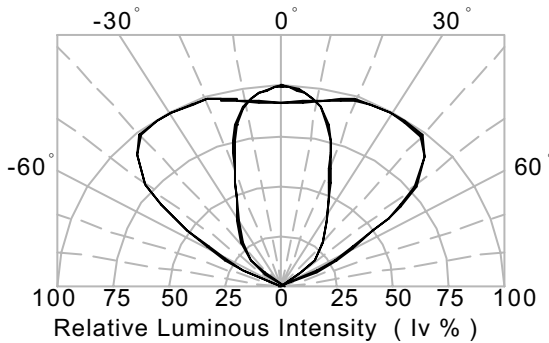

**PACKAGE CONFIGURATION**

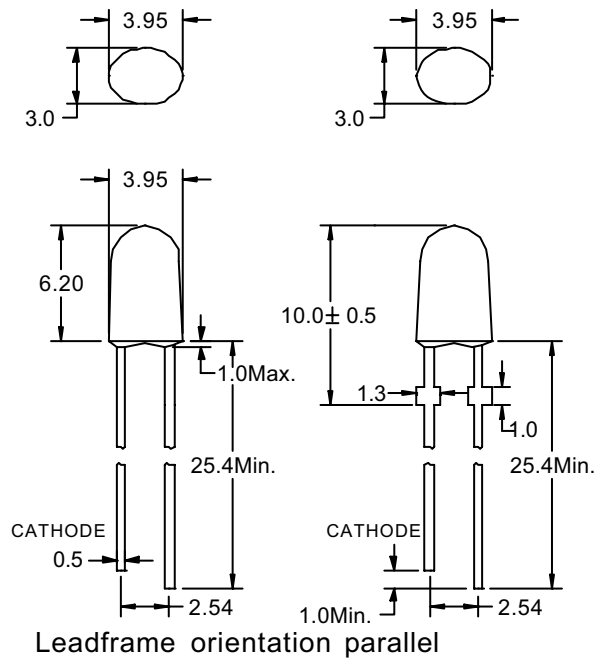

Tolerance ± 0.25 mm

**ABSOLUTE MAXIMUM RATINGS AT Ta = 25 °C**

PARAMETER	MAX.	UNIT
Power Dissipation	80	mW
Continuous Forward Current	30	mA
Peak Forward Current ( 1/10 Duty Cycle , 0.1ms Pulse Width )	160	mA
Reverse Voltage	5	V
Derating Linear From 50 °C	0.4	mA/°C
Operating Temperature Range	-40 °C to + 100 °C	
Storage Temperature Range	-40 °C to + 100 °C	
Lead Solder Temperature 1.6 mm Below Package	260 °C for 5 seconds	

**ELECTRICAL / OPTICAL CHARACTERISTICS AT Ta = 25 °C**

SYMBOL	PARAMETER	TEST COND.	MIN.	TYP.	MAX.	UNIT
V F	Forward Voltage	I F = 20 mA		2.3	2.8	V
I R	Reverse Current	V R = 5V			100	μ A
λ p	Peak Emission Wavelength	I F = 20 mA		634		n m
λ d	Dominant Wavelength	I F = 20 mA		629		n m
2 θ 1/2	Viewing Angle	I F = 20 mA		110/50		Deg

**BIN GRADE LIMITS ( I F = 20 mA ) LUMINOUS INTENSITY / mcd**

Bin	G	H	I	J	K	L
Min.	465	600	780	1000	1300	1680
Max.	600	780	1000	1300	1680	2180

Tolerance ± 15% mcd

\*Bright View reserves the rights to alter specifications and remove availability of products at any time without notice.

\*Dominant Wavelength, λ d is according to CIE Chromaticity Diagram base on color of lamps.

\* θ 1/2 is the off-axis angle where the luminous intensity is one half the on-axis intensity.



# BVU-359QT9

## TYPICAL ELECTRICAL / OPTICAL CHARACTERISTIC CURVES

FIG. 1 Forward Current vs. Forward Voltage  
( $T_a = 25^\circ\text{C}$ )

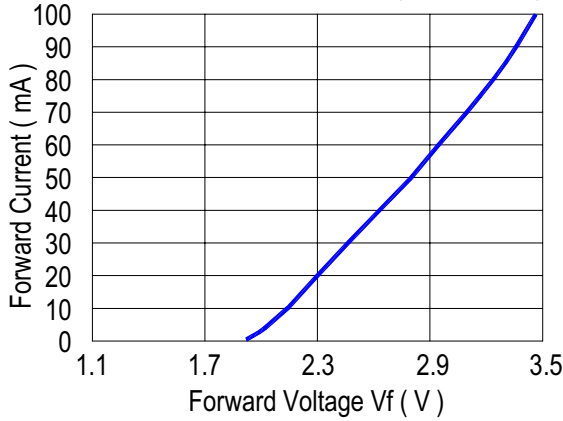

FIG. 2 Relative Intensity vs. Forward Current  
( $T_a = 25^\circ\text{C}$ )

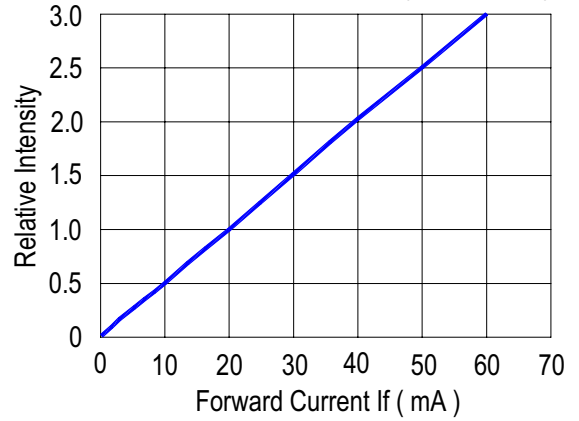

FIG. 3 Forward Voltage vs. Temperature

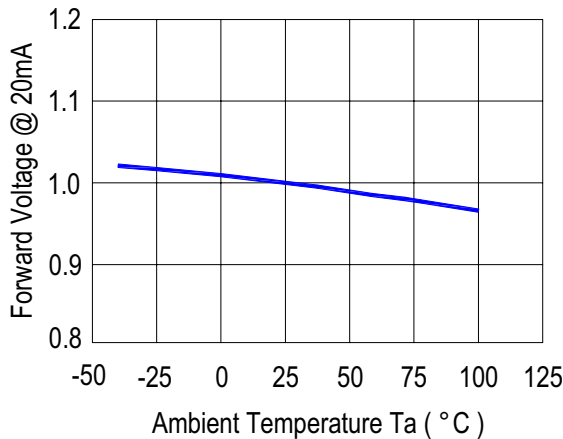

FIG. 4 Relative Intensity vs. Temperature

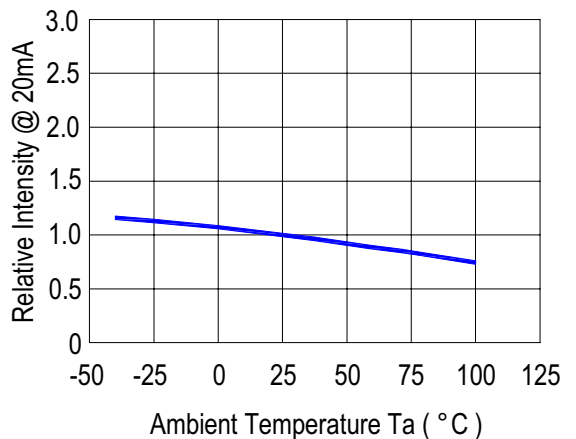

FIG. 5 Relative Intensity vs. Wavelength ( $\lambda_p$ )  
( $T_a = 25^\circ\text{C}$ )

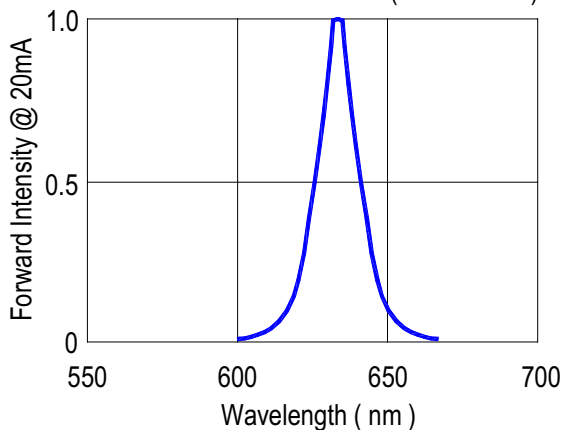
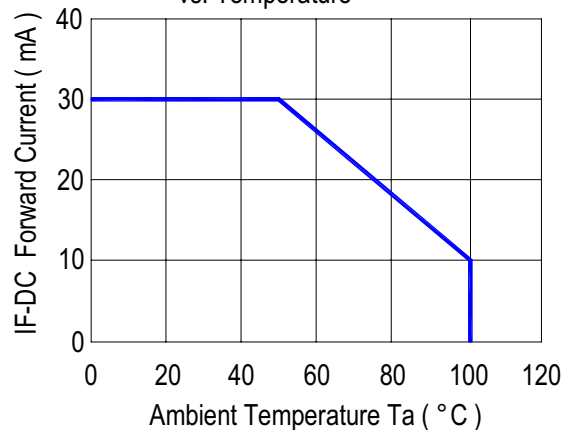

FIG. 6 Maximum Forward Current  
vs. Temperature





## Apply to LAMP(DIP) series.

### Description:

#### (1) Manual soldering (Solder Iron)

- (1.1) Temperature at tip of the iron: 300°C Max.
- (1.2) It's banned to load any stress on the resin during soldering.
- (1.3) Soldering time: 3 sec. Max.(one time only)
- (1.4) Leave 3mm of minimum distance from the base of the epoxy.

#### (2) Dip Soldering(Wave soldering-Solder Bath)

- (2.1) Leave 3mm of minimum distance from the base of the epoxy.  
Soldering beyond the base of the the tie bar(stand off) is recommended.
- (2.2) When soldering, do not put stress on the LEDs during heating.
- (2.3) Cutting the leadframes at high temperatures may cause LED failure.
- (2.4) Never take next process until the component is cooled down to room temperature after reflow.
- (2.5) After soldering, do not warp the circuit board.
- (2.6) The recommended dip soldering profile is the following:

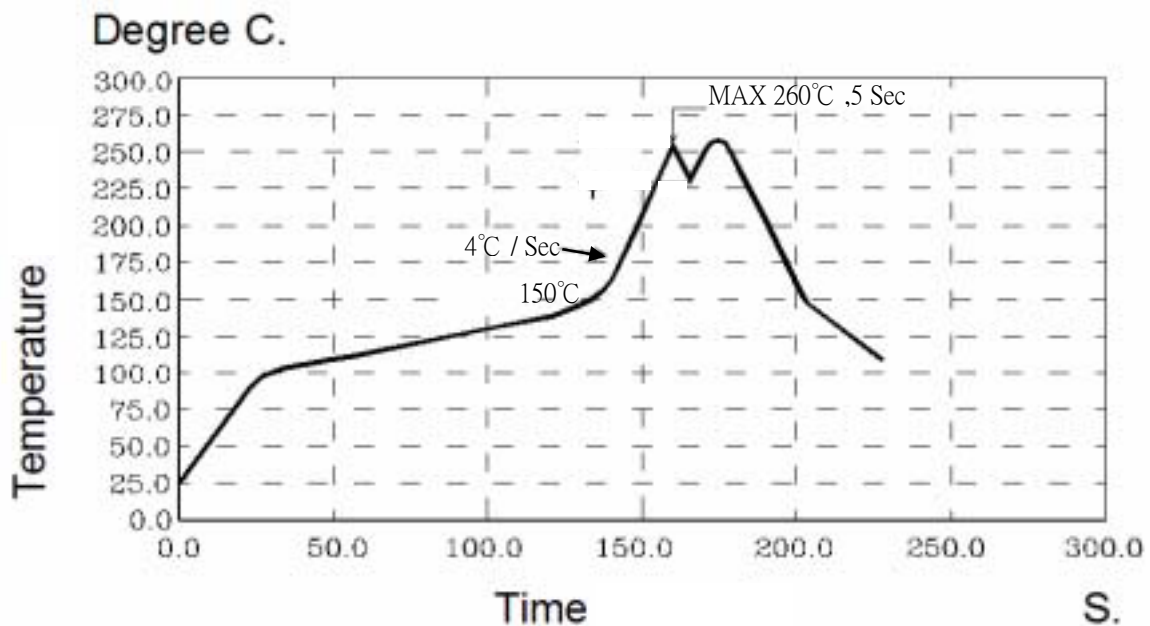



# LAMP PACKING

www.DataSheet4U.com

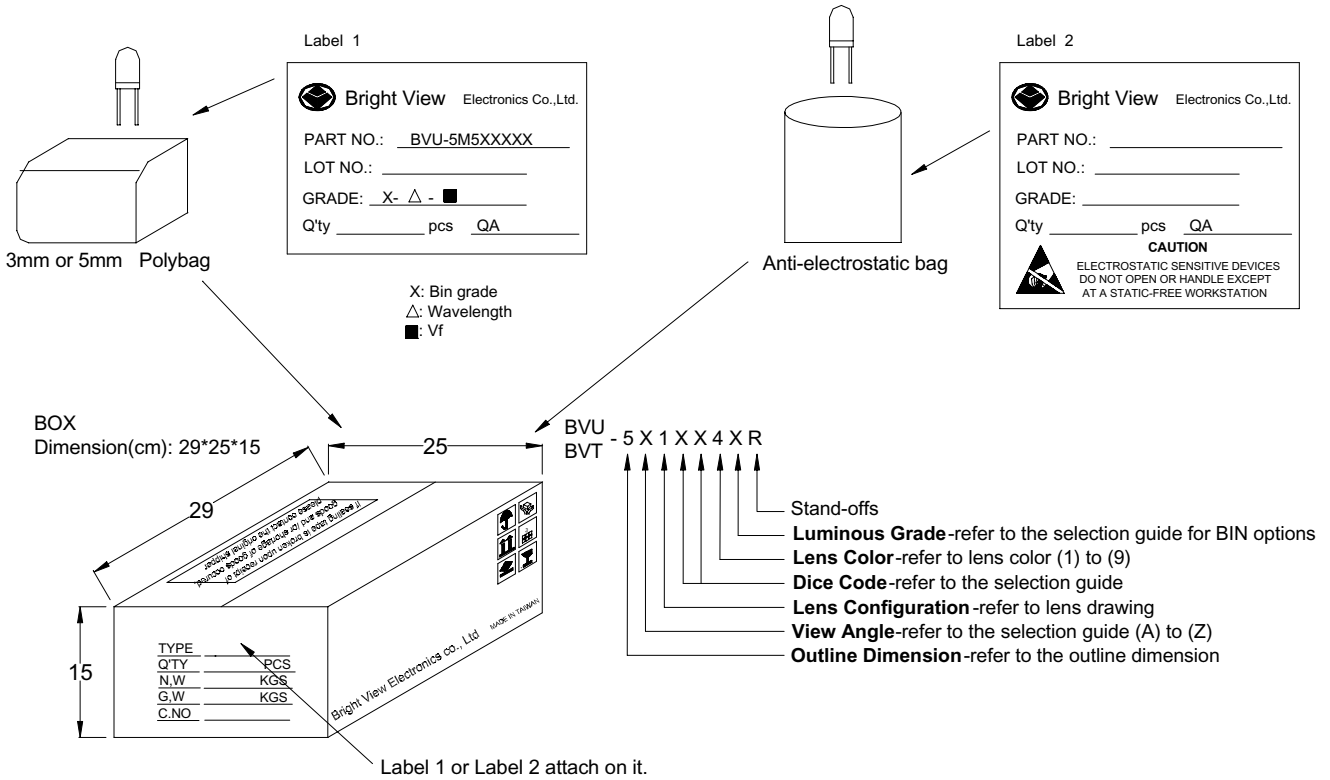

Device	Q'ty / Polybag (pcs)	Polybag / Box A	Fig.
5mm(T-1 3/4)	1000pcs	14 bags	Label 1
3mm(T-1)	1000pcs	20 bags	Label 1
Blue / Green / White	500pcs	18 bags	Label 2

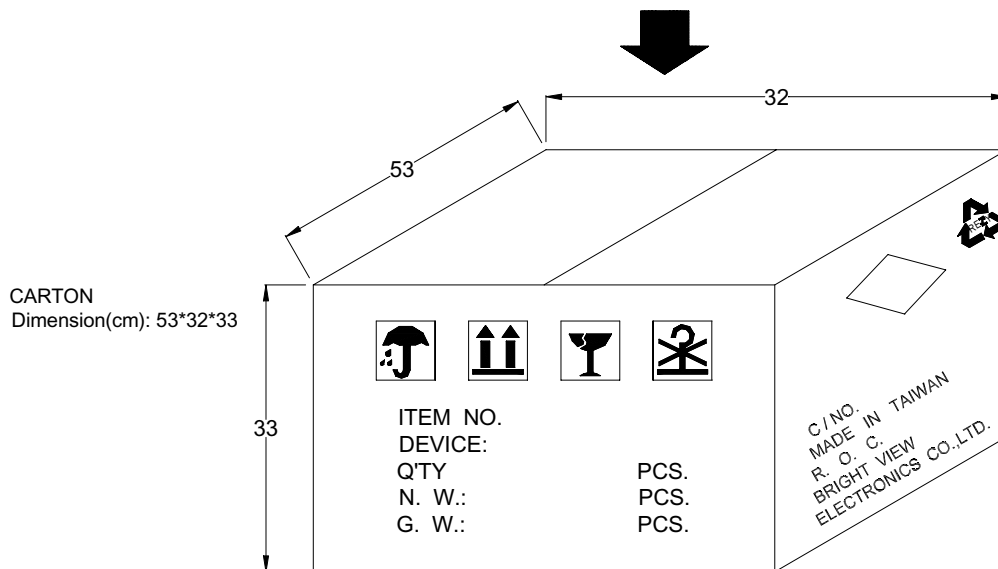

4 Boxes / Carton

5mm : 56,000pcs

3mm : 80,000pcs

Blue / Green / White : 36,000pcs

2003 / 9 / 15 - A