



BVU-3P0RU1

PACKAGE CONFIGURATION

DESCRIPTION

Dice Material : GaAlAs/GaAlAs Red
Light Color : Red Color
Lens Color : Red Diffused
Stand-Off P/N : BVU-3P0RU1 R

RADIATION PATTERN

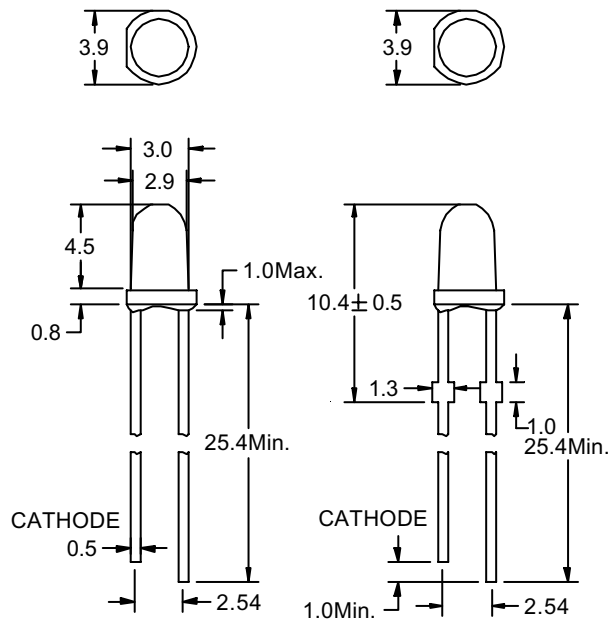
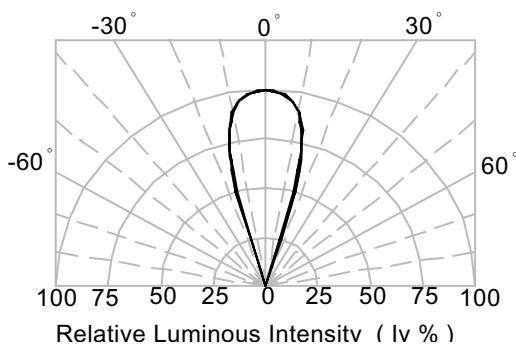

Tolerance ± 0.25 mm

ABSOLUTE MAXIMUM RATINGS AT Ta = 25 °C

PARAMETER	MAX.	UNIT
Power Dissipation	100	mW
Continuous Forward Current	40	mA
Peak Forward Current (1/10 Duty Cycle , 0.1ms Pulse Width)	200	mA
Reverse Voltage	5	V
Derating Linear From 50 °C	0.4	mA/°C
Operating Temperature Range	-40 °C to + 100 °C	
Storage Temperature Range	-40 °C to + 100 °C	
Lead Solder Temperature 1.6 mm Below Package	260 °C for 5 seconds	

ELECTRICAL / OPTICAL CHARACTERISTICS AT Ta = 25 °C

SYMBOL	PARAMETER	TEST COND.	MIN.	TYP.	MAX.	UNIT
V _F	Forward Voltage	I _F = 20 mA		2.1	2.7	V
I _R	Reverse Current	V _R = 5V			100	μA
λ _p	Peak Emission Wavelength	I _F = 20 mA		660		nm
λ _d	Dominant Wavelength	I _F = 20 mA		643		nm
2θ _{1/2}	Viewing Angle	I _F = 20 mA		35		Deg

BIN GRADE LIMITS (I_F = 20 mA) LUMINOUS INTENSITY / mcd

Bin	D	E	F	G	H	I
Min.	218	280	360	465	600	780
Max.	280	360	465	600	780	1000

Tolerance ± 15% mcd

*Bright View reserves the rights to alter specifications and remove availability of products at any time without notice.

*Dominant Wavelength, λ_d is according to CIE Chromaticity Diagram base on color of lamps.

*θ_{1/2} is the off-axis angle where the luminous intensity is one half the on-axis intensity.



GaAlAs/GaAlAs Red LED

TYPICAL ELECTRICAL/OPTICAL CHARACTERISTIC CURVES

FIG. 1 Forward Current Vs. Forward Voltage

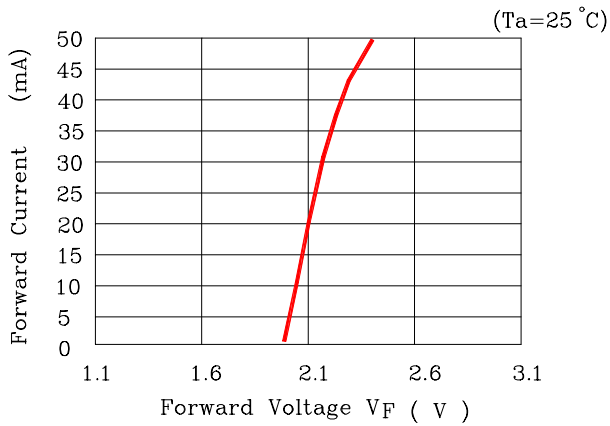

FIG. 2 Relative Intensity Vs. Forward Current

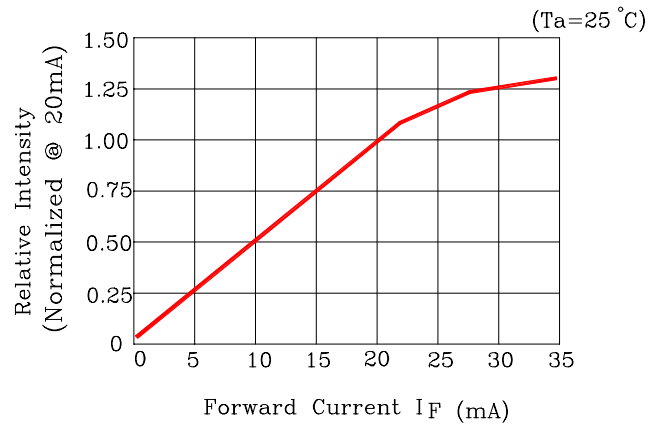

FIG. 3 Forward Voltage VS. Temperature

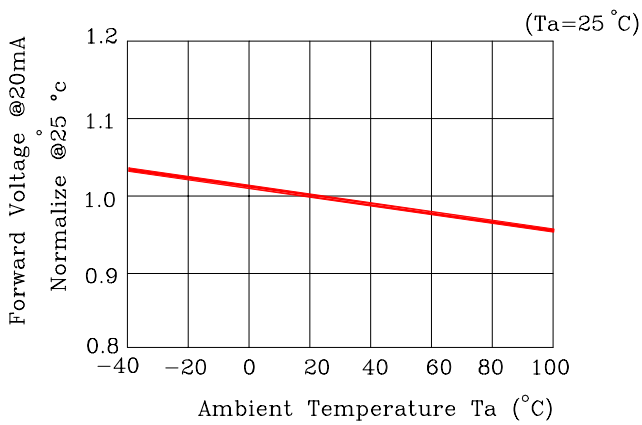

FIG. 4 Relative Intensity vs. Temperature

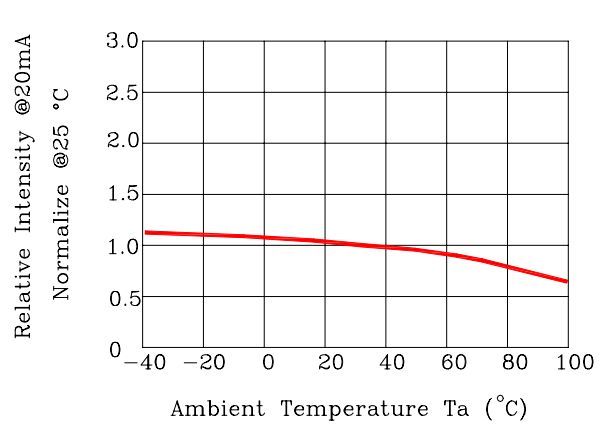

FIG. 5 Relative Intensity vs. Wavelength (λ_p)

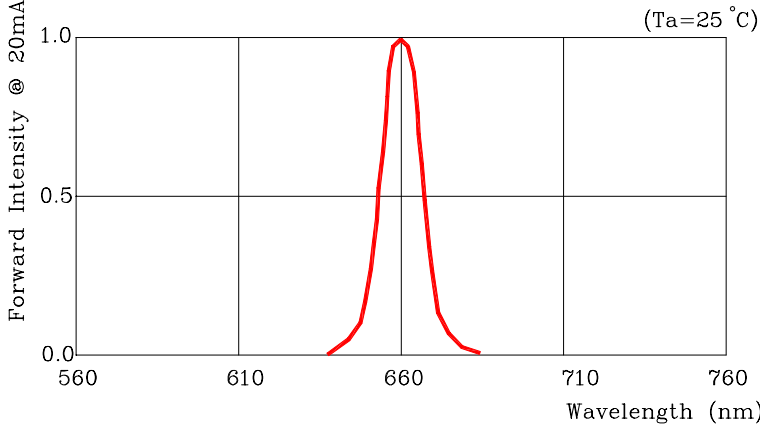
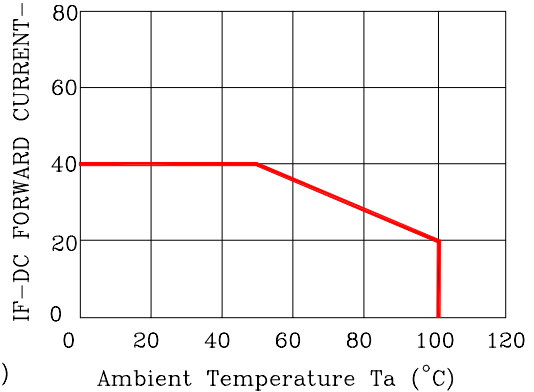
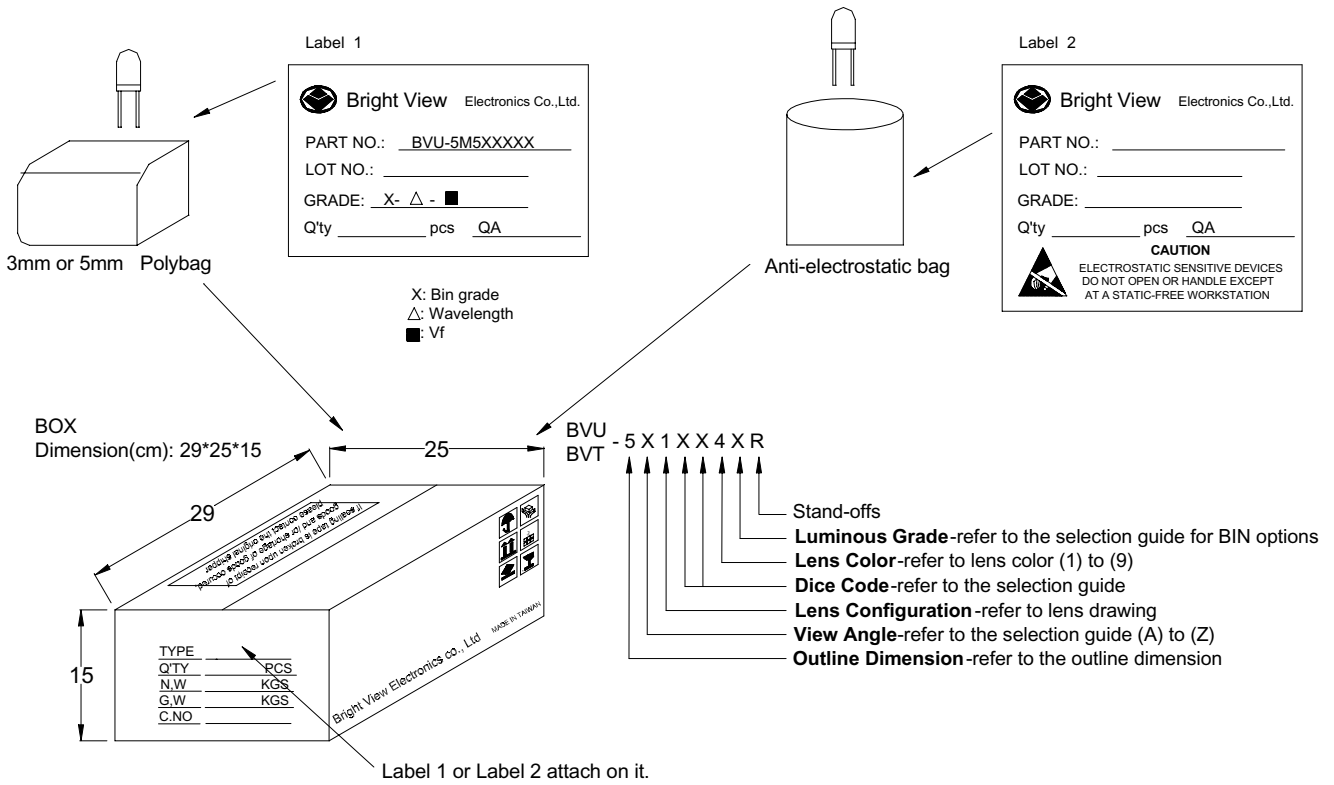
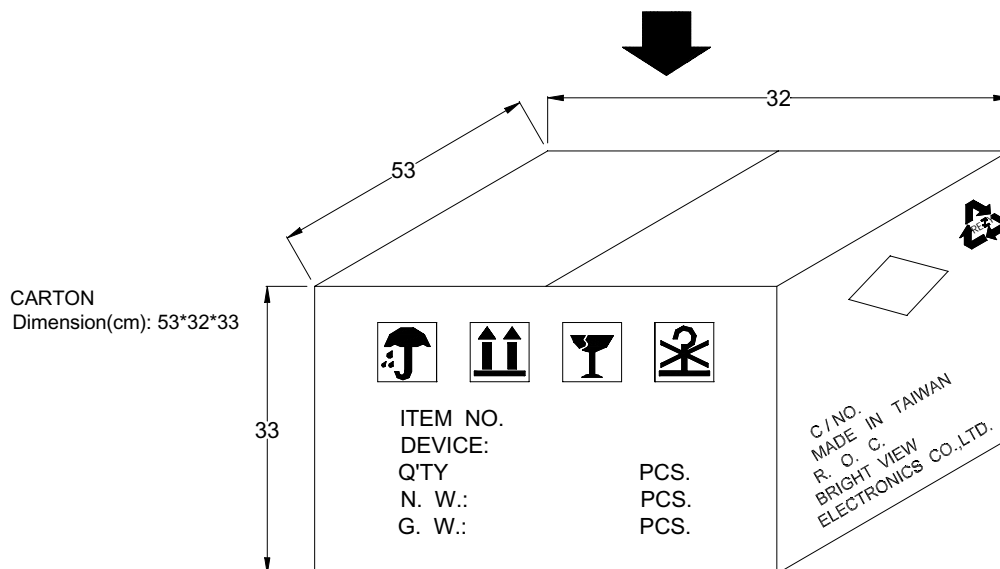

FIG. 6 Maximum Forward Current vs. Ambient Temperature. Derating Based on $T_{MAX}=130^{\circ}C$





Device	Q'ty / Polybag (pcs)	Polybag / Box A	Fig.
5mm(T-1 3/4)	1000pcs	14 bags	Label 1
3mm(T-1)	1000pcs	20 bags	Label 1
Blue / Green / White	500pcs	18 bags	Label 2



4 Boxes / Carton

5mm : 56,000pcs

3mm : 80,000pcs

Blue / Green / White : 36,000pcs