



BVU-529GN8

DESCRIPTION

Dice Material : GaN Green
Light Color : Green Color
Lens Color : Green Tinted Transparent
Stand-Off P/N : BVU-529GN8 R

RADIATION PATTERN

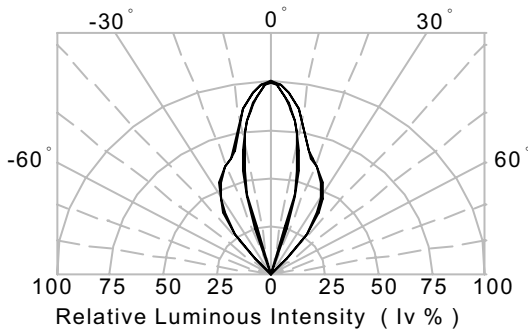

PACKAGE CONFIGURATION

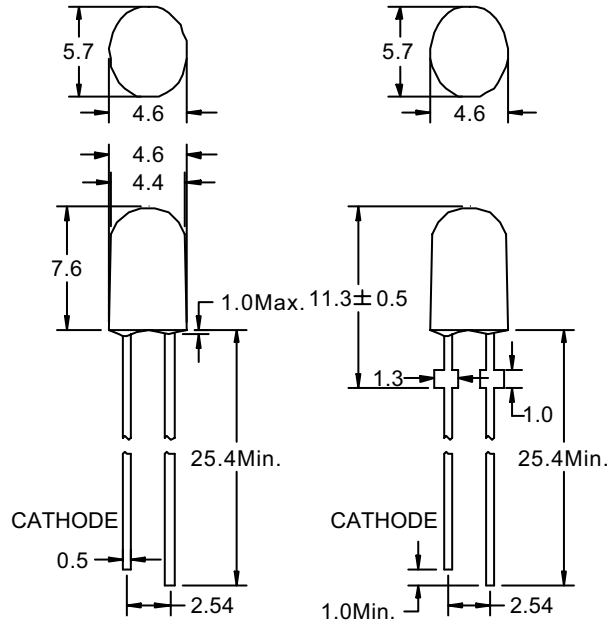

Leadframe orientation perpendicular

Tolerance ± 0.25 mm

ABSOLUTE MAXIMUM RATINGS AT Ta = 25 °C

PARAMETER	MAX.	UNIT
Power Dissipation	120	mW
Continuous Forward Current	30	mA
Peak Forward Current (1/10 Duty Cycle , 0.1ms Pulse Width)	100	mA
Reverse Voltage	5	V
Derating Linear From 25 °C	0.4	mA/°C
Operating Temperature Range	-30 °C to + 80 °C	
Storage Temperature Range	-40 °C to + 100 °C	
Lead Solder Temperature 1.6 mm Below Package	260 °C for 5 seconds	

ELECTRICAL / OPTICAL CHARACTERISTICS AT Ta = 25 °C

SYMBOL	PARAMETER	TEST COND.	MIN.	TYP.	MAX.	UNIT
V F	Forward Voltage	I F = 20 mA		3.3	4.0	V
I R	Reverse Current	V R= 5V			10	μA
λ p	Peak Emission Wavelength	I F = 20 mA		520		n m
λ d	Dominant Wavelength	I F = 20 mA		525		n m
2 θ 1/2	Viewing Angle	I F = 20 mA		60/30		Deg

BIN GRADE LIMITS (I F = 20 mA) LUMINOUS INTENSITY / mcd

Bin	N	O	P	Q	R	S
Min.	2800	3600	4650	6000	7800	10000
Max.	3600	4650	6000	7800	10000	13000

Tolerance ± 15% mcd

*Bright View reserves the rights to alter specifications and remove availability of products at any time without notice.

*Dominant Wavelength, λ d is according to CIE Chromaticity Diagram base on color of lamps.

* θ 1/2 is the off-axis angle where the luminous intensity is one half the on-axis intensity.

*These products are sensitive to static electricity. Caution must be taken strictly to avoid static electricity.



BVU-529GN8

TYPICAL ELECTRICAL / OPTICAL CHARACTERISTIC CURVES

FIG. 1 Forward Current vs. Forward Voltage
($T_a = 25^\circ\text{C}$)

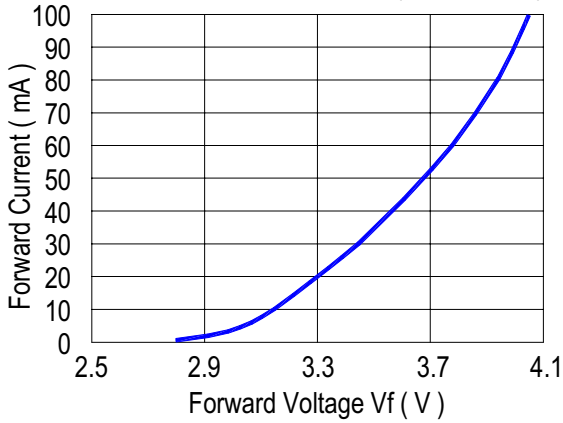

FIG. 2 Relative Intensity vs. Forward Current
($T_a = 25^\circ\text{C}$)

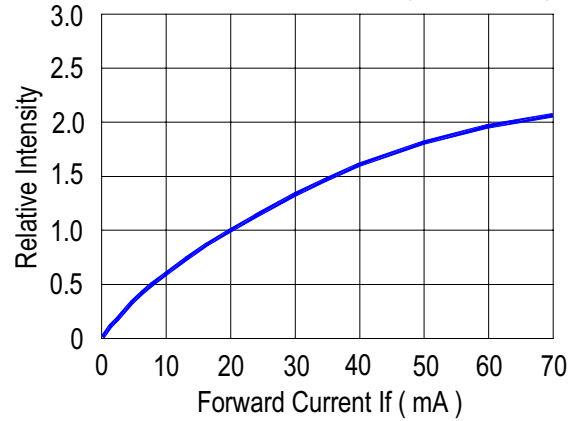

FIG. 3 Forward Voltage vs. Temperature

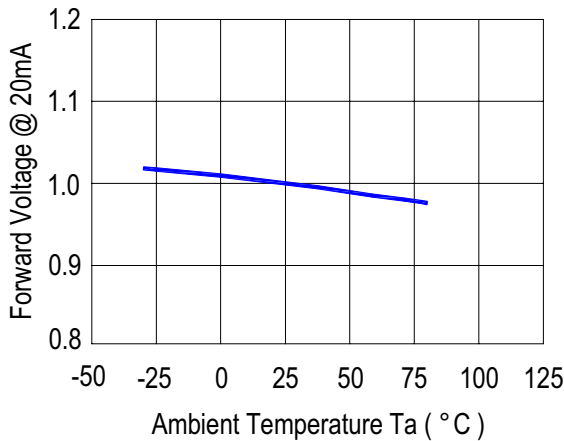

FIG. 4 Relative Intensity vs. Temperature

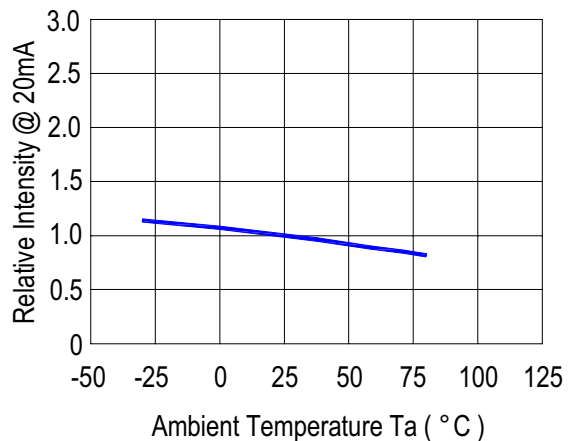

FIG. 5 Relative Intensity vs. Wavelength (λ_p)
($T_a = 25^\circ\text{C}$)

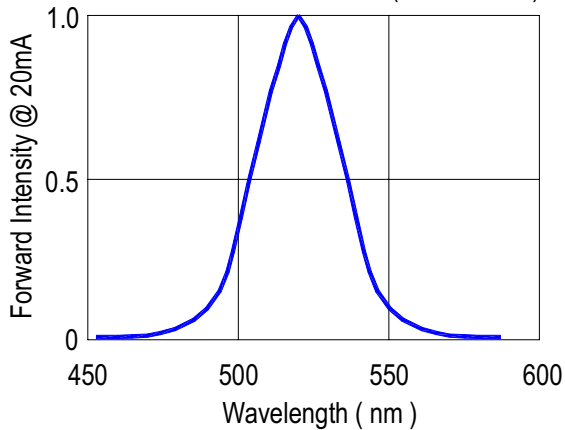
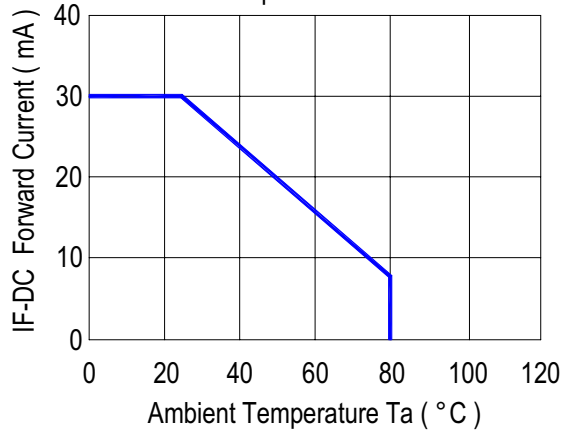

FIG. 6 Maximum Forward Current
vs. Temperature





BRIGHT VIEW
ELECTRONICS CO.,LTD

CAUTION FOR STATIC ELECTRICITY(BASE UPON MACHINE MODE)

靜電防治

These products are Gallium Nitride(GaN) light emitting diodes(LEDs). There are extremely sensitive to static electricity ESD damage. The user must take absolutely secure countermeasures against static electricity and surge when handling products.

顯明 LED 晶片材質為 Gallium Nitride(GaN)，此材質對於靜電極為敏感，十分容易受靜電衝擊而產生破壞，使用者接觸產品時必需做好對靜電衝擊之防護措施。

Bright View BA, GN, WI are GaN materials are ESD classified as "Class 1", any manufacturing or workstations where GaN devices are handled should be rated at 50V or below.

顯明之 BA、GN、WI 晶片材質為 GaN，此材質屬 ESD 規範中的"Class 1"等級，任何 GaN 產品所會被接觸的製造或工作站必須控制在 50V 以下。

Proper grounding of products (via $1M\Omega$), use of conductive mat, semiconductive working uniform and shoes, and semiconductive containers are considered to be effective as countermeasures against static electricity and surge.

適當的產品接地（ $1M\Omega$ ）與使用導電桌墊，並評估考慮穿著防靜電工作服、防靜電鞋與防靜電盒來有效地防制靜電之衝擊。

An ionizer is recommended to be used in the facility or environment where static electricity may be generated easily, and soldering iron with a grounded tip is also recommended.

建議對於工廠設施與環境中容易產生靜電的地點使用離子風扇吹拂，且也建議使用有接地功能的烙鐵進行焊接。

To install a protection device, in the LED driving circuit, which does not exceed the max rating for surge current during on/off switching.

在驅動 LED 的電路上設置保護裝置，使其當開閉時的瞬間電流不會超出最大電壓值。



Apply to LAMP(DIP) series.

Description:

(1) Manual soldering (Solder Iron)

- (1.1) Temperature at tip of the iron: 300°C Max.
- (1.2) It's banned to load any stress on the resin during soldering.
- (1.3) Soldering time: 3 sec. Max.(one time only)
- (1.4) Leave 3mm of minimum distance from the base of the epoxy.

(2) Dip Soldering(Wave soldering-Solder Bath)

- (2.1) Leave 3mm of minimum distance from the base of the epoxy.
Soldering beyond the base of the the tie bar(stand off) is recommended.
- (2.2) When soldering, do not put stress on the LEDs during heating.
- (2.3) Cutting the leadframes at high temperatures may cause LED failure.
- (2.4) Never take next process until the component is cooled down to room temperature after reflow.
- (2.5) After soldering, do not warp the circuit board.
- (2.6) The recommended dip soldering profile is the following:

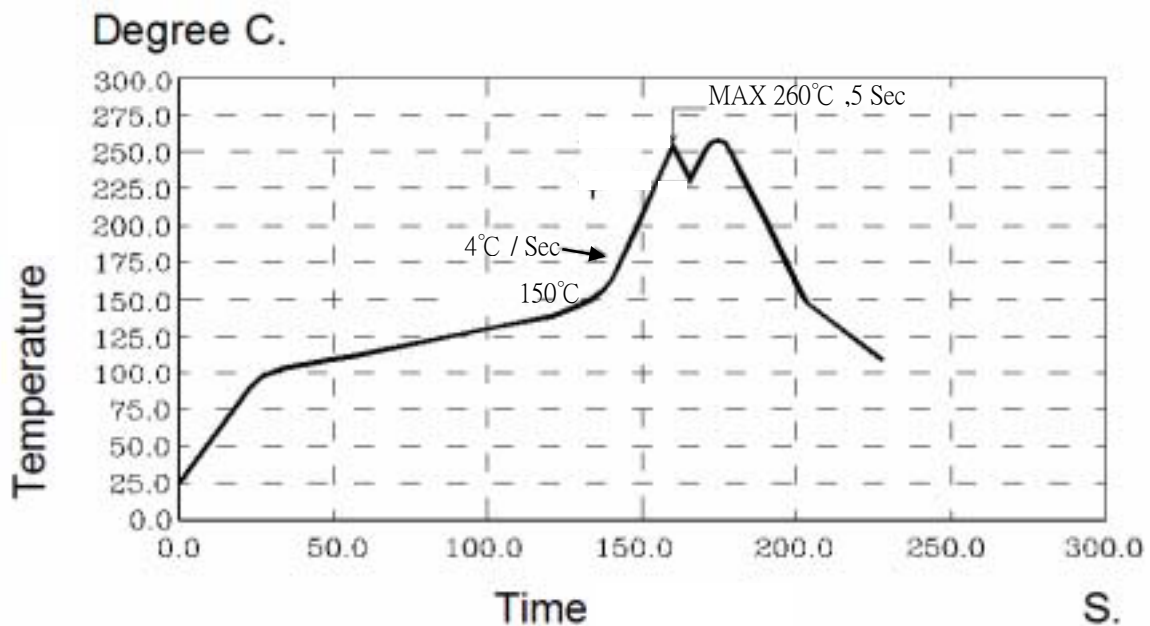



LAMP PACKING

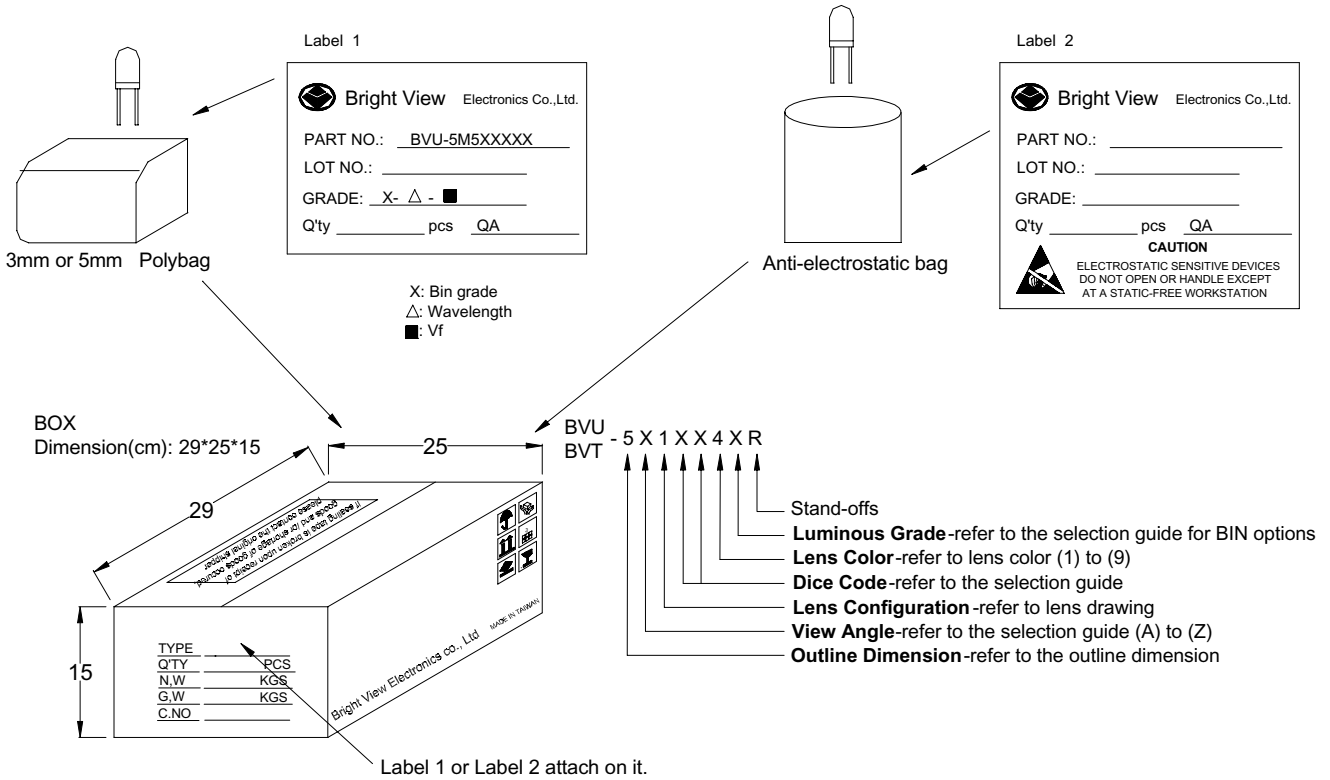

Device	Q'ty / Polybag (pcs)	Polybag / Box A	Fig.
5mm(T-1 3/4)	1000pcs	14 bags	Label 1
3mm(T-1)	1000pcs	20 bags	Label 1
Blue / Green / White	500pcs	18 bags	Label 2

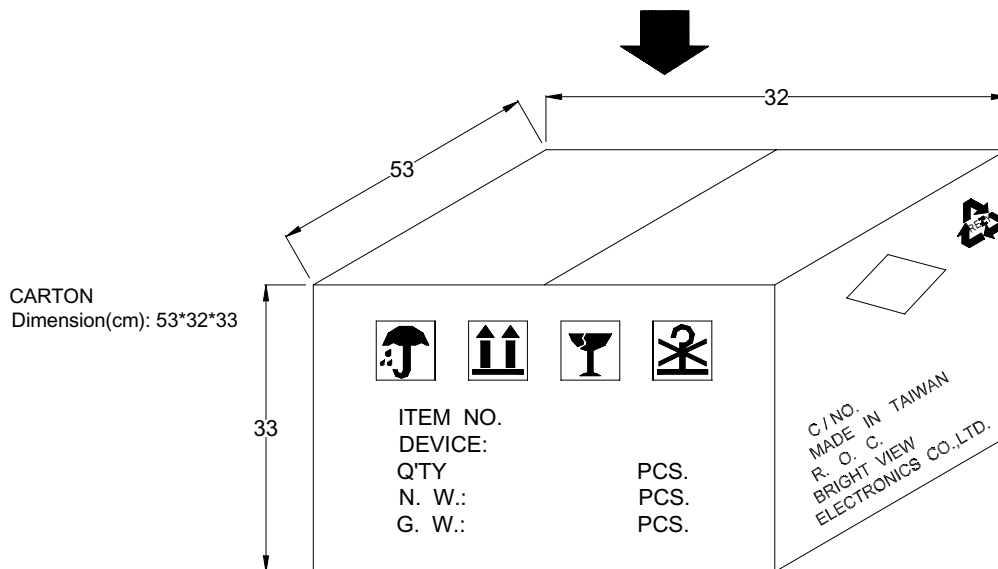

4 Boxes / Carton

5mm : 56,000pcs

3mm : 80,000pcs

Blue / Green / White : 36,000pcs

2003 / 9 / 15 - A