



**BVU-5E1GN4**

**PACKAGE CONFIGURATION**

**DESCRIPTION**

Dice Material : GaN Green  
Light Color : Green Color  
Lens Color : Water Transparent  
Stand-Off P/N : BVU-5E1GN4 R

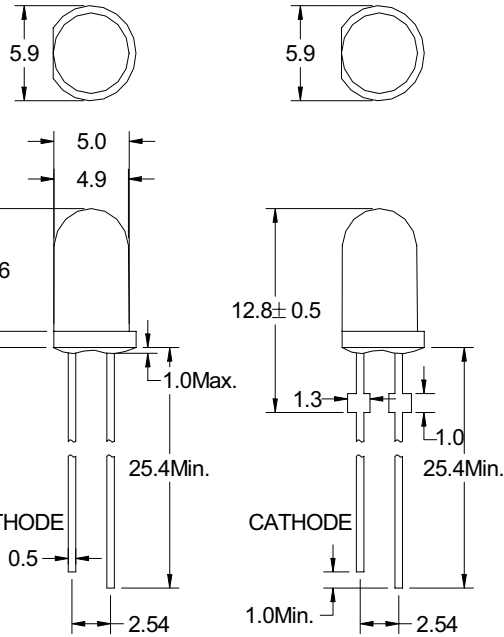

**RADIATION PATTERN**

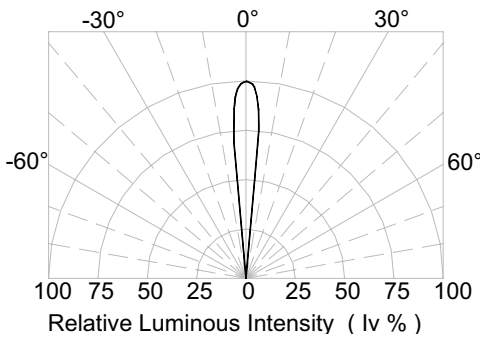

Tolerance ± 0.25 mm

**ABSOLUTE MAXIMUM RATINGS AT Ta = 25 °C**

PARAMETER	MAX.	UNIT
Power Dissipation	120	mW
Continuous Forward Current	30	mA
Peak Forward Current ( 1/10 Duty Cycle , 0.1ms Pulse Width )	100	mA
Reverse Voltage	5	V
Derating Linear From 25 °C	0.4	mA/°C
Operating Temperature Range	-30 °C to + 80 °C	
Storage Temperature Range	-40 °C to + 100 °C	
Lead Solder Temperature 1.6 mm Below Package 260 °C for 5 seconds		

**ELECTRICAL / OPTICAL CHARACTERISTICS AT Ta = 25 °C**

SYMBOL	PARAMETER	TEST COND.	MIN.	TYP.	MAX.	UNIT
V <sub>F</sub>	Forward Voltage	I <sub>F</sub> = 20 mA		3.3	4.0	V
I <sub>R</sub>	Reverse Current	V <sub>R</sub> = 5V			10	μA
λ <sub>p</sub>	Peak Emission Wavelength	I <sub>F</sub> = 20 mA		520		nm
λ <sub>d</sub>	Dominant Wavelength	I <sub>F</sub> = 20 mA		525		nm
2θ <sub>1/2</sub>	Viewing Angle	I <sub>F</sub> = 20 mA		15		Deg

**BIN GRADE LIMITS ( I F = 20 mA ) LUMINOUS INTENSITY / mcd**

Bin	Q	R	S	T	U	V
Min.	6000	7800	10000	13000	16800	21800
Max.	7800	10000	13000	16800	21800	28000

Tolerance ± 15% mcd

\*Bright View reserves the rights to alter specifications and remove availability of products at any time without notice.

\*Dominant Wavelength, λ<sub>d</sub> is according to CIE Chromaticity Diagram base on color of lamps.

\*θ<sub>1/2</sub> is the off-axis angle where the luminous intensity is one half the on-axis intensity.

\*These products are sensitive to static electricity. Caution must be taken strictly to avoid static electricity.



# BVU-5E1GN4

## TYPICAL ELECTRICAL / OPTICAL CHARACTERISTIC CURVES

FIG. 1 Forward Current vs. Forward Voltage  
( $T_a = 25^\circ\text{C}$ )

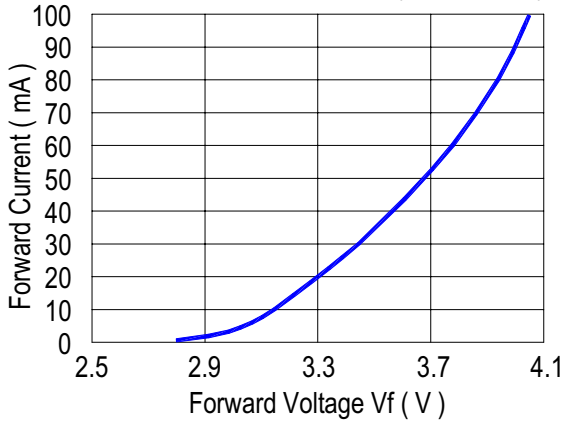

FIG. 2 Relative Intensity vs. Forward Current  
( $T_a = 25^\circ\text{C}$ )

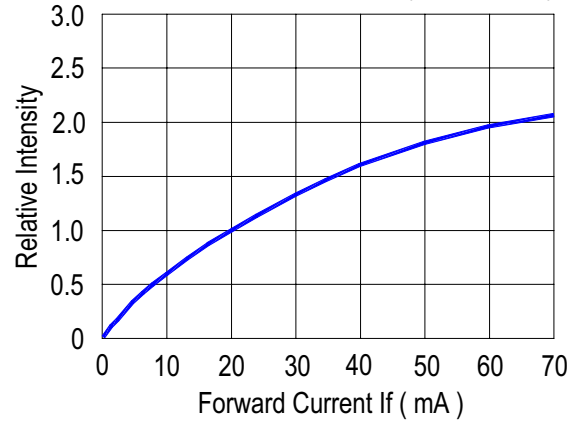

FIG. 3 Relative Voltage vs. Temperature

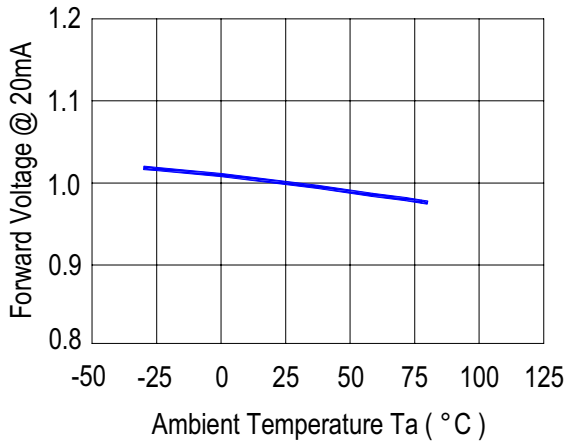

FIG. 4 Relative Intensity vs. Temperature

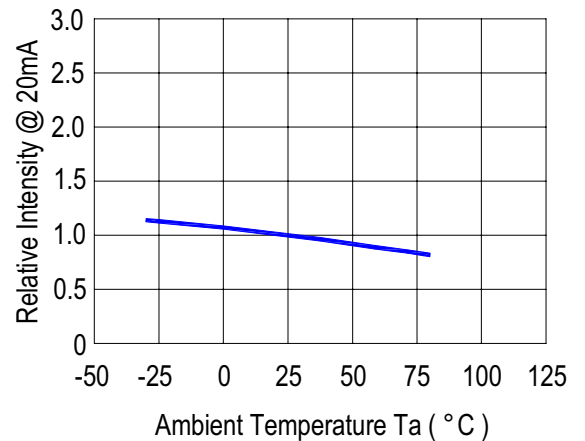

FIG. 5 Relative Intensity vs. Wavelength ( $\lambda_p$ )  
( $T_a = 25^\circ\text{C}$ )

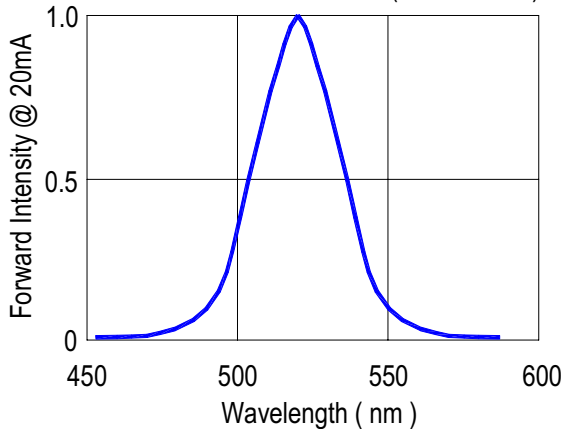
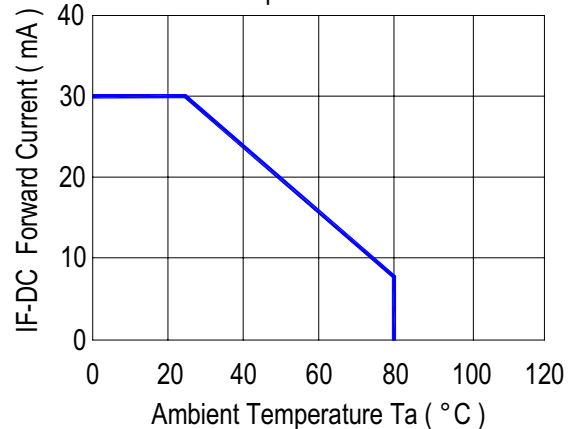

FIG. 6 Maximum Forward Current  
vs. Temperature





BRIGHT VIEW  
ELECTRONICS CO.,LTD

### **CAUTION FOR CLASS 1 ESD ( MACHINE MODE )**

Gallium Nitride (GaN) based light emitting diodes (LEDs) are extremely sensitive to electrostatic discharge (ESD). Users are strongly recommended to take necessary meter to test the static and avoid ESD when handling these products.

Bright View's BA, GN, WI series products are GaN based materials and are classified as "Class 1", ( ESD endurance 50V or lower ), any manufacturing site or workstation where GaN devices are handled should be rated and controlled at 50V or below.

Proper grounding of products or machines (via  $1M\Omega$ ), using static dissipative mats, static dissipative containers, static dissipative working uniforms and shoes are considered to be effective against ESD.

An ionizer is recommended in the facility or environment where ESD may be generated easily, and soldering iron with a grounded tip is also recommended.

To install a protection device in the LED circuit to ensure the surge current and voltage not exceeding the max rating during on/off switching.

When inspecting the final products in which LEDs are assembled, it is recommended to check whether the assembled LEDs are damaged by ESD or not. It is simple to find damaged LEDs by light-on or a VF test at lower current (below 1mA is recommended).

EDS damaged LEDs will show some unusual characteristics such as the remarkable increasing of leak current, the forward voltage become lower, or the LEDs do not light on at the low current.

DOC. NO.:S-QW-K011  
2006/03/17 –A



### Apply to LAMP(DIP) series.

## Description:

### (1) Manual soldering (Solder Iron)

- (1.1) Temperature at tip of the iron: 300°C Max.
- (1.2) It's banned to load any stress on the resin during soldering.
- (1.3) Soldering time: 3 sec. Max.(one time only)
- (1.4) Leave 3mm of minimum distance from the base of the epoxy.

### (2) Dip Soldering(Wave soldering-Solder Bath)

- (2.1) Leave 3mm of minimum distance from the base of the epoxy.  
Soldering beyond the base of the the tie bar(stand off) is recommended.
- (2.2) When soldering, do not put stress on the LEDs during heating.
- (2.3) Cutting the leadframes at high temperatures may cause LED failure.
- (2.4) Never take next process until the component is cooled down to room temperature after reflow.
- (2.5) After soldering, do not warp the circuit board.
- (2.6) The recommended dip soldering profile is the following:

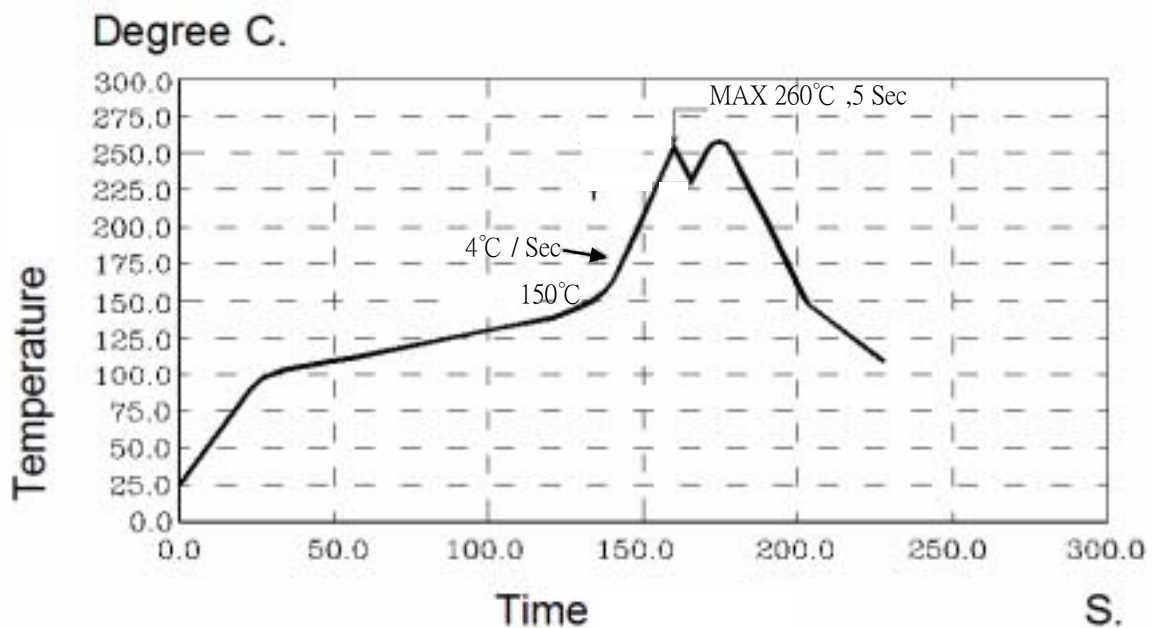

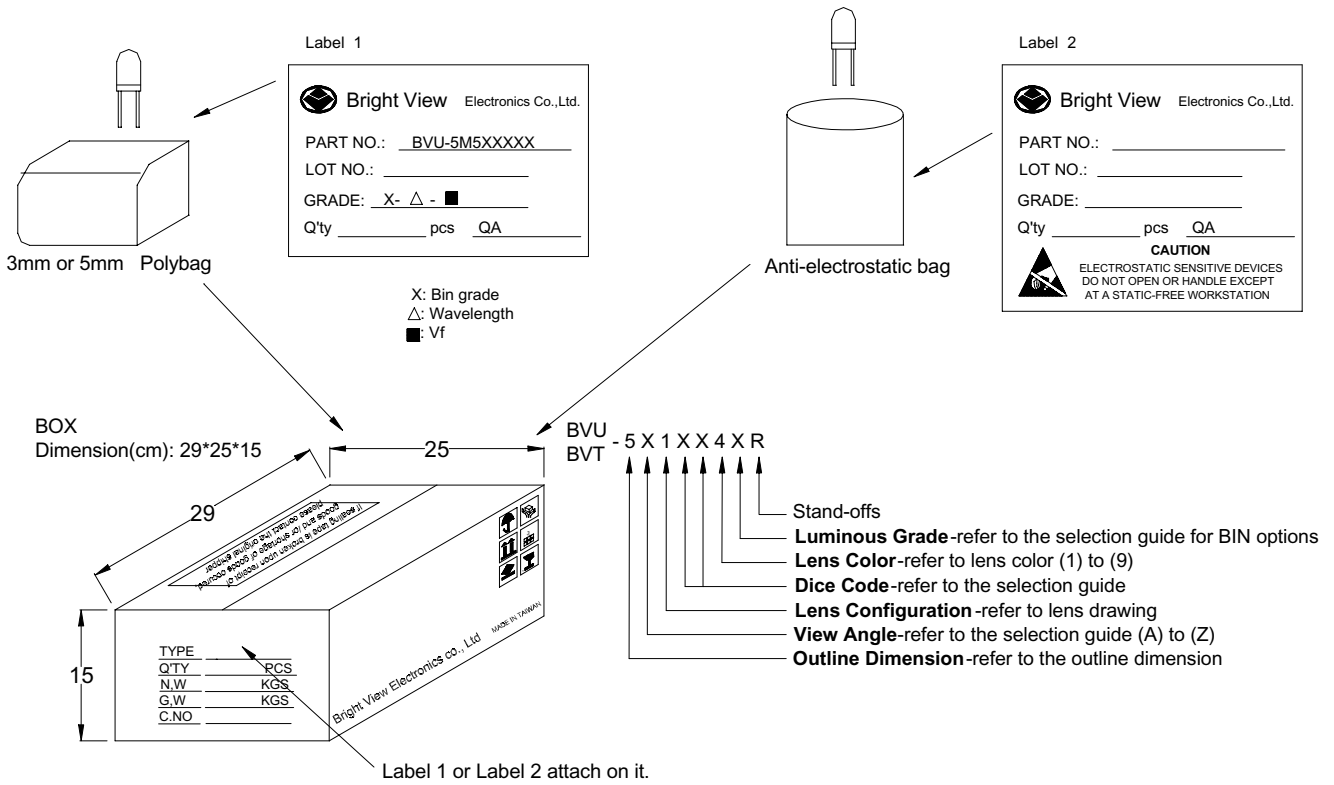

Device	Q'ty / Polybag (pcs)	Polybag / Box A	Fig.
5mm(T-1 3/4)	1000pcs	14 bags	Label 1
3mm(T-1)	1000pcs	20 bags	Label 1
Blue / Green / White	500pcs	18 bags	Label 2

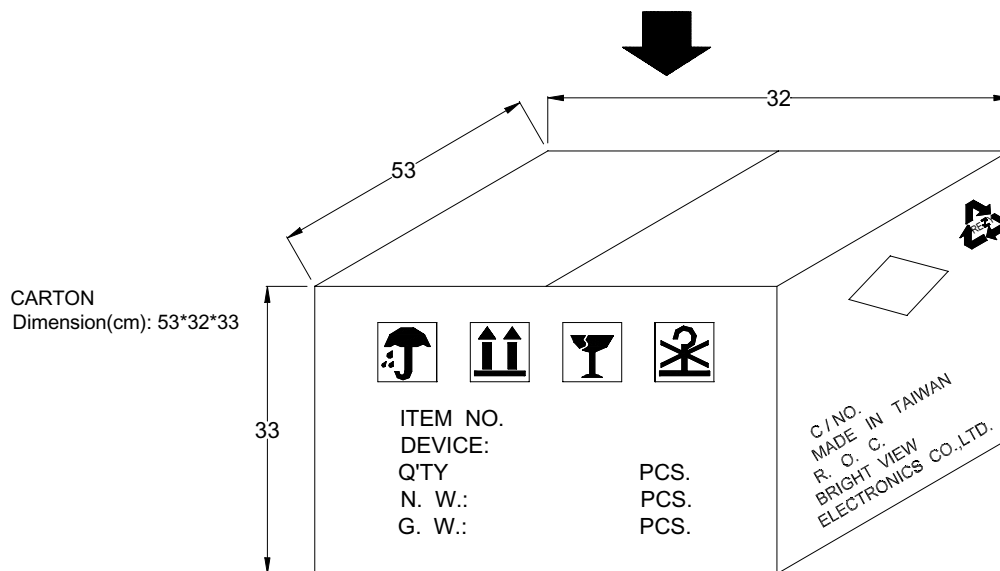

4 Boxes / Carton  
5mm : 56,000pcs  
3mm : 80,000pcs  
Blue / Green / White : 36,000pcs