



BVU-5E1TT4

PACKAGE CONFIGURATION

DESCRIPTION

Dice Material : AlInGaP Yellow
Light Color : Yellow Color
Lens Color : Water Transparent
Stand-Off P/N : BVU-5E1TT4 R

RADIATION PATTERN

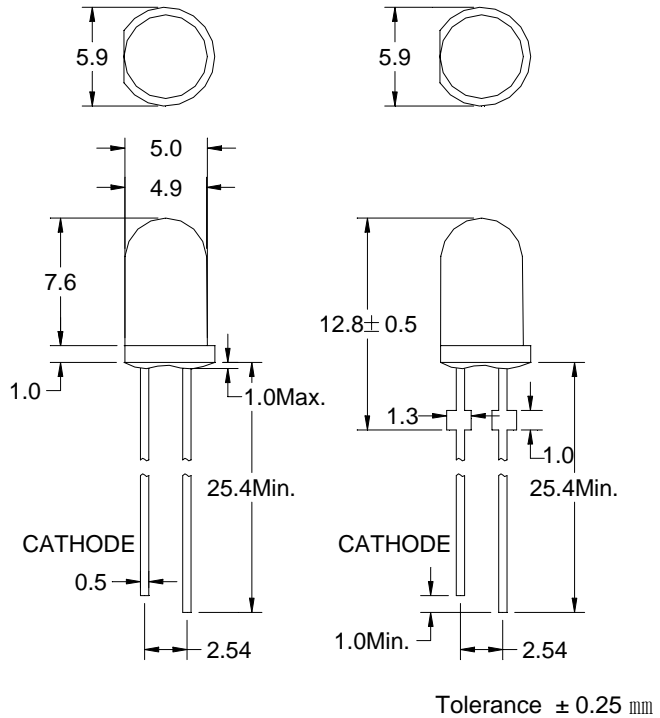
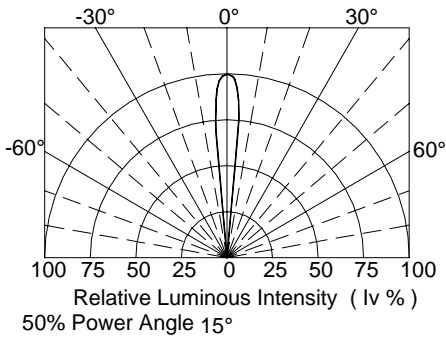

ABSOLUTE MAXIMUM RATINGS AT Ta = 25 °C

PARAMETER	MAX.	UNIT
Power Dissipation (PD)	80	mW
Continuous Forward Current (IF)	30	mA
Peak Forward Current (1/10 Duty Cycle , 0.1ms Pulse Width) (IFP)	160	mA
Reverse Voltage (VR)	5	V
Derating Linear From 50 °C	0.4	mA/°C
Operating Temperature Range (Topr)	-40 °C to + 100 °C	
Storage Temperature Range (Tstg)	-40 °C to + 100 °C	
Lead Solder Temperature 1.6 mm Below Package 260 °C for 5 seconds (Tsltd)		

ELECTRICAL / OPTICAL CHARACTERISTICS AT Ta = 25 °C

SYMBOL	PARAMETER	TEST COND.	MIN.	TYP.	MAX.	UNIT
V _F	Forward Voltage	I _F = 20 mA		2.3	2.8	V
I _R	Reverse Current	V _R = 5V			100	μA
λ _p	Peak Emission Wavelength	I _F = 20 mA		592		nm
λ _d	Dominant Wavelength	I _F = 20 mA		590		nm
2θ _{1/2}	Viewing Angle	I _F = 20 mA		15		Deg
I _v	Luminous Intensity	I _F = 20 mA	2800	4125		mcd

BIN GRADE LIMITS (IF=20 mA)

LUMINOUS INTENSITY / mcd

Bin	N	O	P	Q	R	S
Min.	2800	3600	4650	6000	7800	10000
Max.	3600	4650	6000	7800	10000	13000

BIN GRADE LIMITS (IF=20 mA)

DOMINANT WAVELENGTH / nm

Bin	YC	YD	YE	YF	YG
Min.	583	586	589	592	595
Max.	586	589	592	595	598

Tolerance ± 15% mcd

*Bright View reserves the rights to alter specifications and remove availability of products at any time without notice.

*Dominant Wavelength, λ_d is according to CIE Chromaticity Diagram base on color of lamps.

*θ_{1/2} is the off-axis angle where the luminous intensity is one half the on-axis intensity.



BVU-5E1TT4

TYPICAL ELECTRICAL / OPTICAL CHARACTERISTIC CURVES

FIG. 1 Forward Current vs. Forward Voltage
($T_a = 25^\circ\text{C}$)

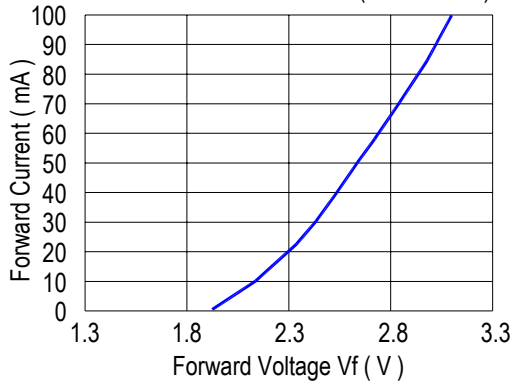

FIG. 2 Relative Intensity vs. Forward Current
($T_a = 25^\circ\text{C}$)

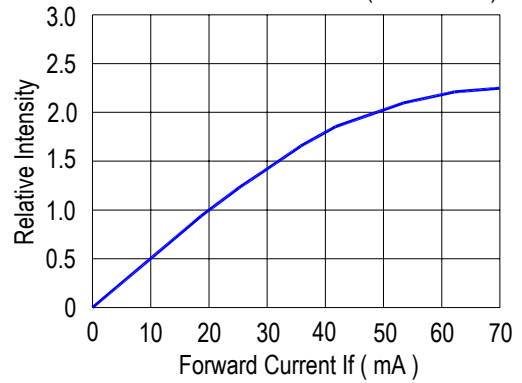

FIG. 3 Relative Voltage vs. Temperature

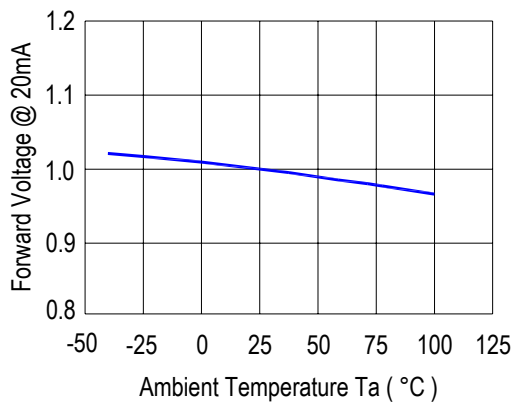

FIG. 4 Relative Intensity vs. Temperature

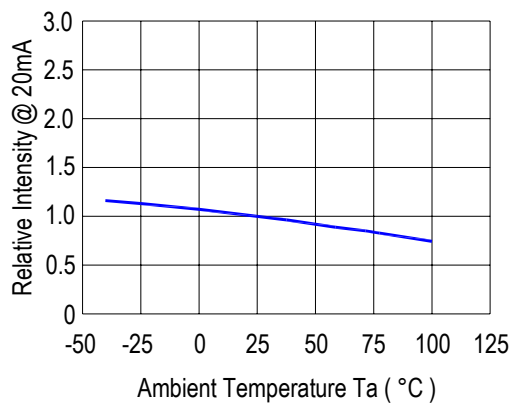

FIG. 5 Relative Intensity vs. Wavelength (λ_p)
($T_a = 25^\circ\text{C}$)

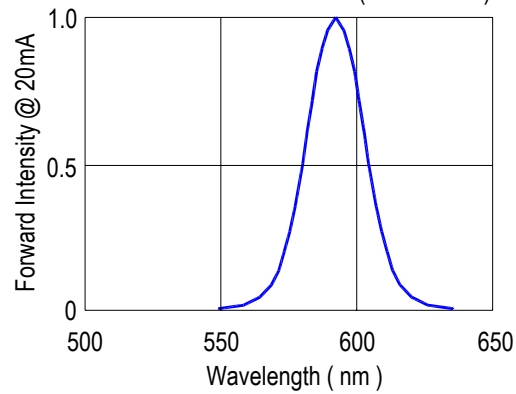
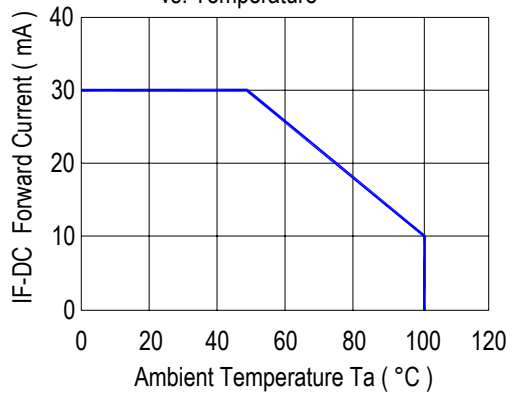

FIG. 6 Maximum Forward Current
vs. Temperature





BVU-5E1TT4

Apply to LAMP(DIP) series.

Description:

(1) Manual soldering (Solder Iron)

- (1.1) Temperature at tip of the iron: 300°C Max.
- (1.2) It's banned to load any stress on the resin during soldering.
- (1.3) Soldering time: 3 sec. Max.(one time only)
- (1.4) Leave 3mm of minimum distance from the base of epoxy.

(2) Dip Soldering(Wave soldering-Solder Bath)

- (2.1) Leave 3mm of minimum distance from the base of the epoxy.
Soldering beyond the base of the tie bar(stand off) is recommended.
- (2.2) When soldering, do not put stress on the LEDs during heating.
- (2.3) Cutting the leadframes at high temperatures may cause LED failure.
- (2.4) Never take next process until the component is cooled down to room temperature after reflow.
- (2.5) After soldering, do not warp the circuit board.
- (2.6) The recommended dip soldering profile is the following:

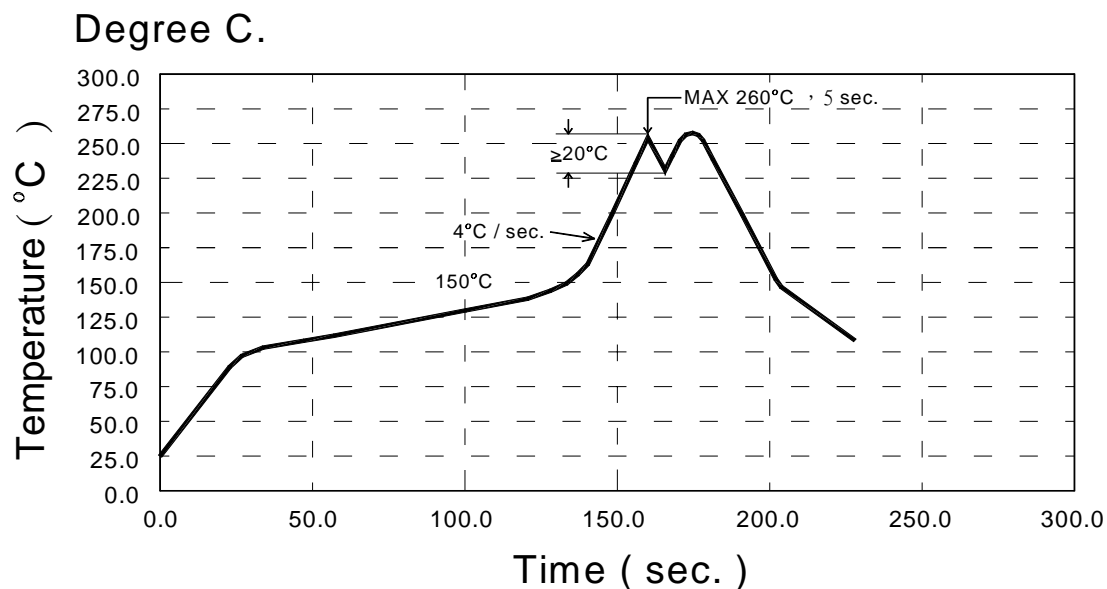



BVU-5E1TT4

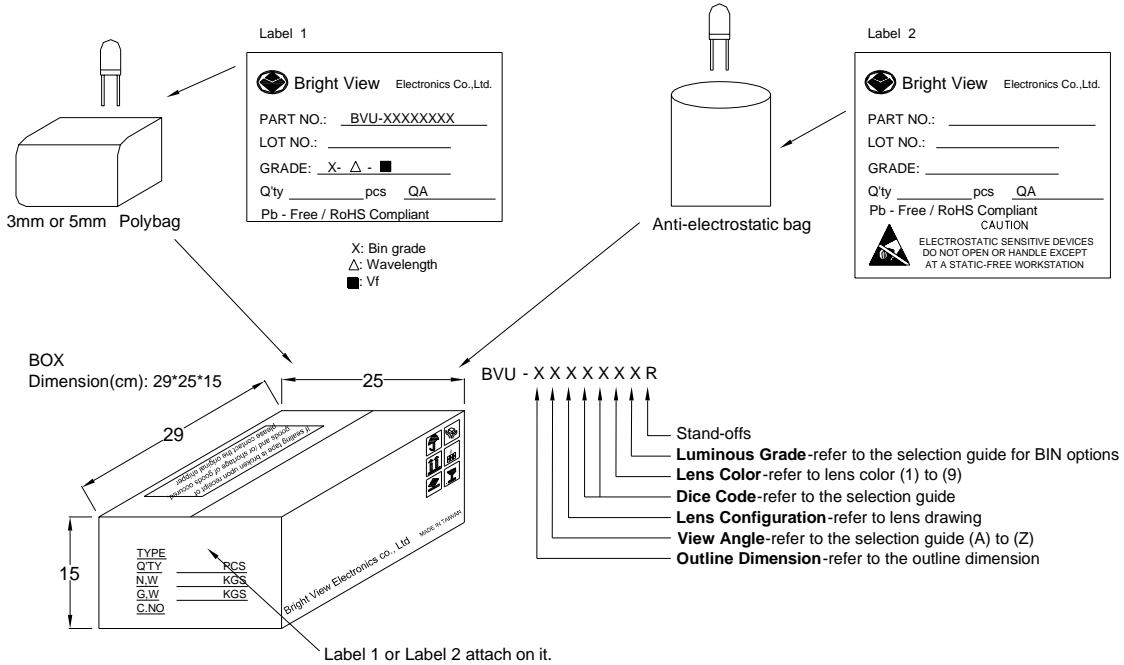

Device	Q'ty / Polybag (pcs)	Polybag / Box A	Fig.
5mm(T-1 3/4)	1000pcs	14 bags	Label 1
3mm(T-1)	1000pcs	20 bags	Label 1
Blue / Green / White	500pcs	18 bags	Label 2

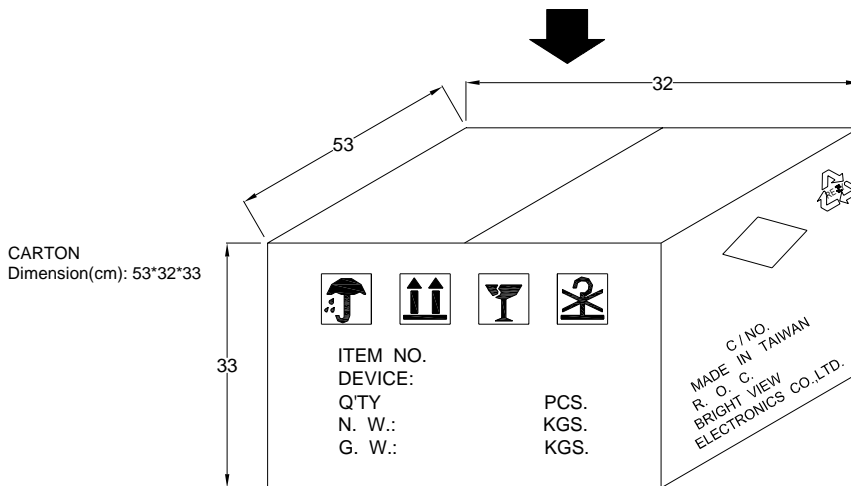

4 Boxes / Carton
5mm : 56,000pcs
3mm : 80,000pcs
Blue / Green / White : 36,000pcs