



**BVU-5K5TT4**

**PACKAGE CONFIGURATION**

**DESCRIPTION**

- Dice Material : AlInGaP Yellow
- Light Color : Yellow Color
- Lens Color : Water Transparent
- Stand-Off P/N : BVU-5K5TT4 R

**RADIATION PATTERN**

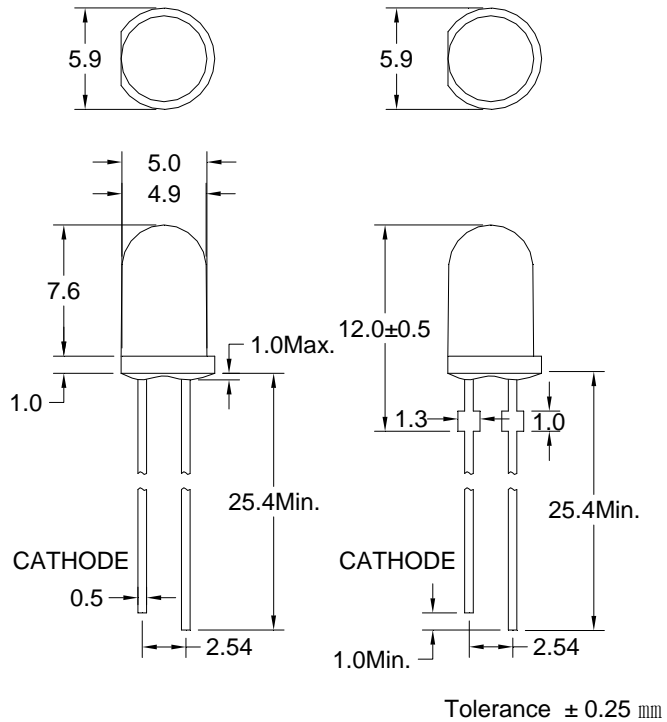
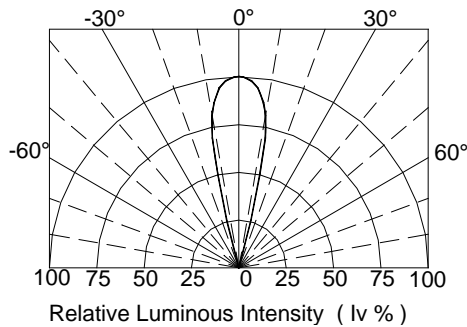

**ABSOLUTE MAXIMUM RATINGS AT Ta = 25 °C**

PARAMETER	MAX.	UNIT
Power Dissipation (PD)	80	mW
Continuous Forward Current (IF)	30	mA
Peak Forward Current ( 1/10 Duty Cycle , 10ms Pulse Width ) (IFP)	100	mA
Reverse Voltage (VR)	5	V
Derating Linear From 50 °C	0.4	mA/°C
Operating Temperature Range (Topr)	-30 °C to + 85 °C	
Storage Temperature Range (Tstg)	-40 °C to + 100 °C	
Lead Solder Temperature 1.6 mm Below Package 260 °C for 5 seconds (Tsltd)		

**ELECTRICAL / OPTICAL CHARACTERISTICS AT Ta = 25 °C**

SYMBOL	PARAMETER	TEST COND.	MIN.	TYP.	MAX.	UNIT
V <sub>F</sub>	Forward Voltage	I <sub>F</sub> = 20 mA		2.3	2.8	V
I <sub>R</sub>	Reverse Current	V <sub>R</sub> = 5V			100	μA
λ <sub>p</sub>	Peak Emission Wavelength	I <sub>F</sub> = 20 mA		592		nm
λ <sub>d</sub>	Dominant Wavelength	I <sub>F</sub> = 20 mA		590		nm
2θ <sub>1/2</sub>	Viewing Angle	I <sub>F</sub> = 20 mA		25		Deg
I <sub>v</sub>	Luminous Intensity	I <sub>F</sub> = 20 mA	6000	7800		mcd

**BIN GRADE LIMITS (IF=20 mA)**

**LUMINOUS INTENSITY / mcd**

Bin	Q	R	S
Min.	6000	7800	10000
Max.	7800	10000	13000

Tolerance ± 15% mcd

**BIN GRADE LIMITS (IF=20 mA)**

**DOMINANT WAVELENGTH / nm**

Bin	YD	YE	YF
Min.	586	589	592
Max.	589	592	595

\*Bright View reserves the rights to alter specifications and remove availability of products at any time without notice.

\*Dominant Wavelength, λ<sub>d</sub> is according to CIE Chromaticity Diagram base on color of lamps.

\*θ<sub>1/2</sub> is the off-axis angle where the luminous intensity is one half the on-axis intensity.



# BVU-5K5TT4

## TYPICAL ELECTRICAL / OPTICAL CHARACTERISTIC CURVES

FIG. 1 Forward Current vs. Forward Voltage  
( $T_a = 25^\circ\text{C}$ )

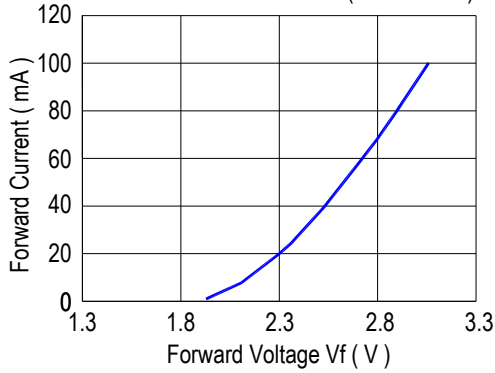

FIG. 2 Relative Intensity vs. Forward Current  
( $T_a = 25^\circ\text{C}$ )

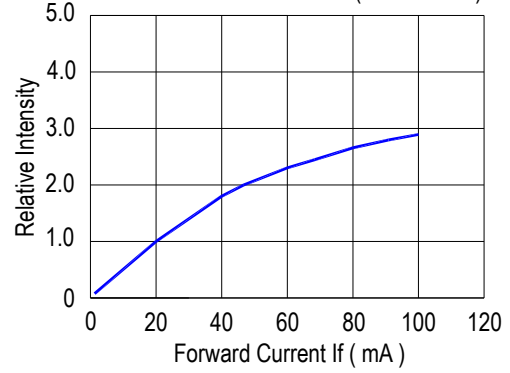

FIG. 3 Forward Voltage vs. Temperature  
( $I_f = 20\text{ mA}$ )

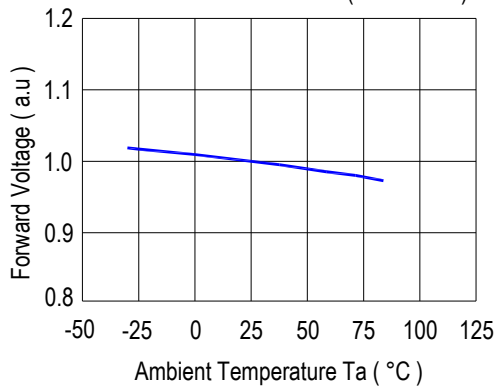

FIG. 4 Relative Intensity vs. Temperature  
( $I_f = 20\text{ mA}$ )

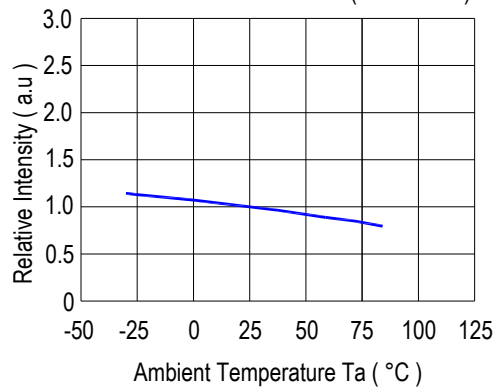

FIG. 5 Relative Intensity vs. Wavelength ( $\lambda_p$ )  
( $T_a = 25^\circ\text{C}$ )

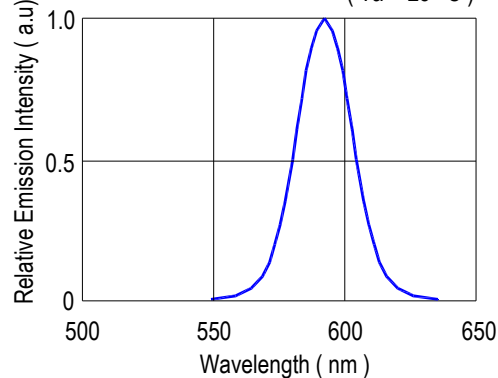
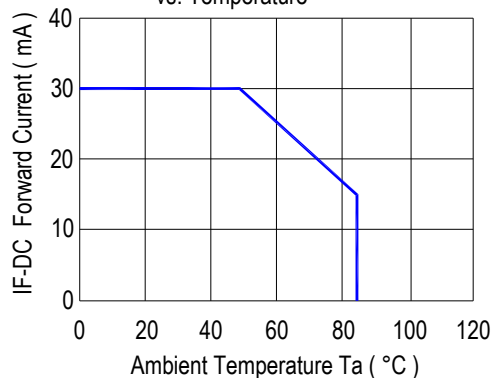

FIG. 6 Maximum Forward Current  
vs. Temperature





## BVU-5K5TT4

### Apply to LAMP(DIP) series.

#### Description:

##### ( 1 ) Manual soldering (Solder Iron)

- (1.1) Temperature at tip of the iron: 300°C Max.
- (1.2) It's banned to load any stress on the resin during soldering.
- (1.3) Soldering time: 5 sec. Max.(one time only)
- (1.4) Leave 1.6mm of minimum distance from the base of epoxy.

##### ( 2 ) Dip Soldering(Wave soldering-Solder Bath)

- (2.1) Leave 1.6mm of minimum distance from the base of the epoxy.  
Soldering beyond the base of the tie bar(stand off) is recommended.
- (2.2) When soldering, do not put stress on the LEDs during heating.
- (2.3) Cutting the leadframes at high temperatures may cause LED failure.
- (2.4) Never take next process until the component is cooled down to room temperature after reflow.
- (2.5) After soldering, do not warp the circuit board.
- (2.6) The recommended dip soldering profile is the following:

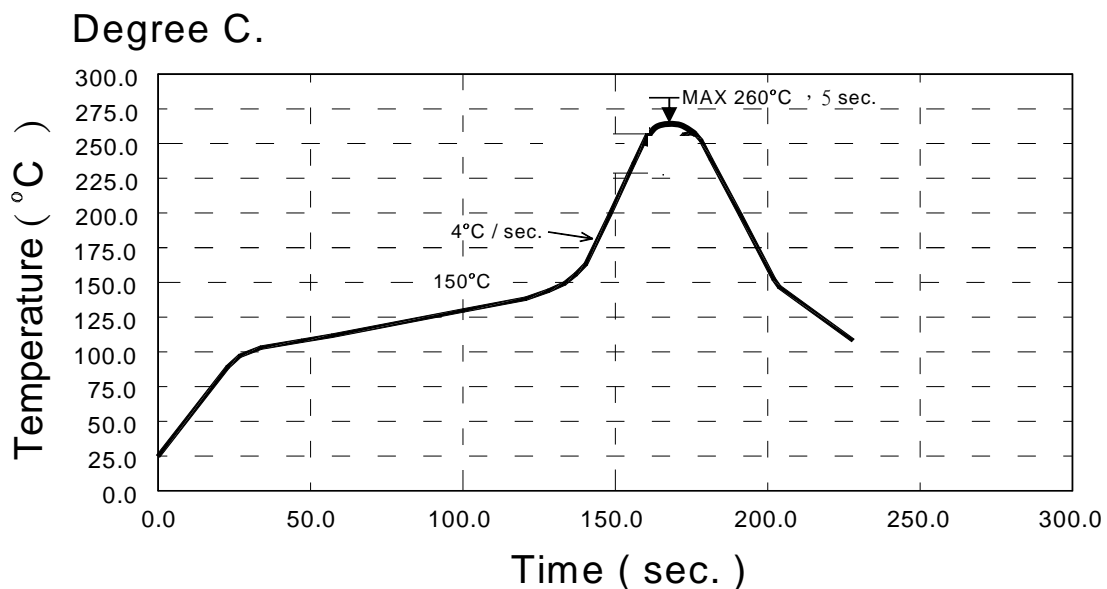



BVU-5K5TT4

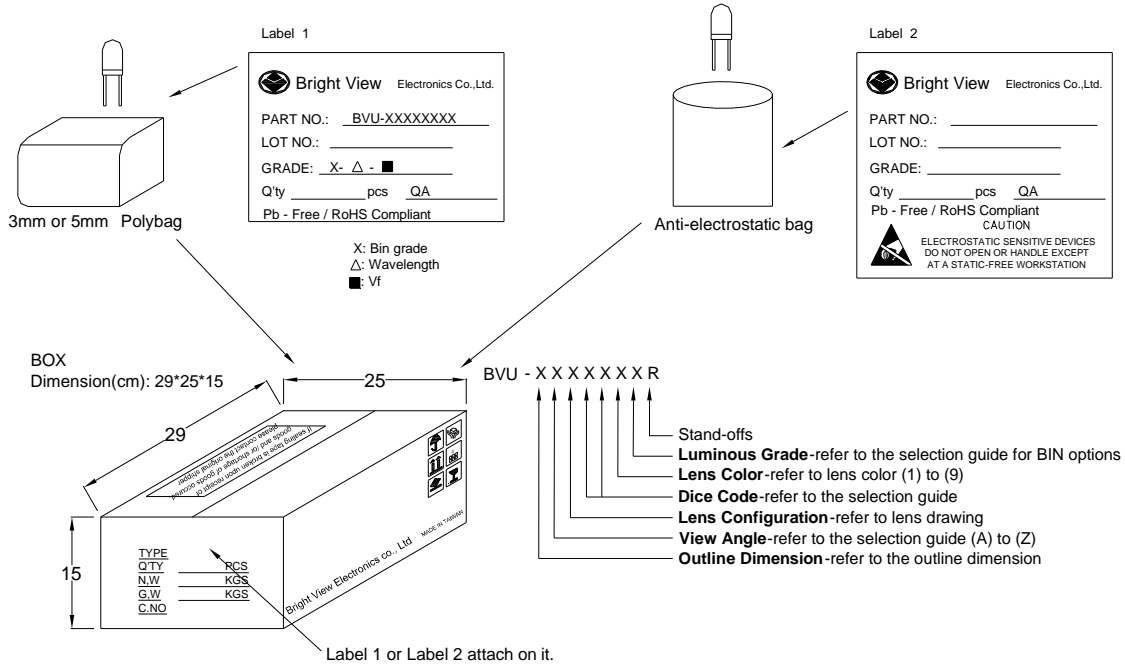

Device	Q'ty / Polybag (pcs)	Polybag / Box A	Fig.
5mm(T-1 3/4)	1000pcs	14 bags	Label 1
3mm(T-1)	1000pcs	20 bags	Label 1
Blue / Green / White	500pcs	18 bags	Label 2

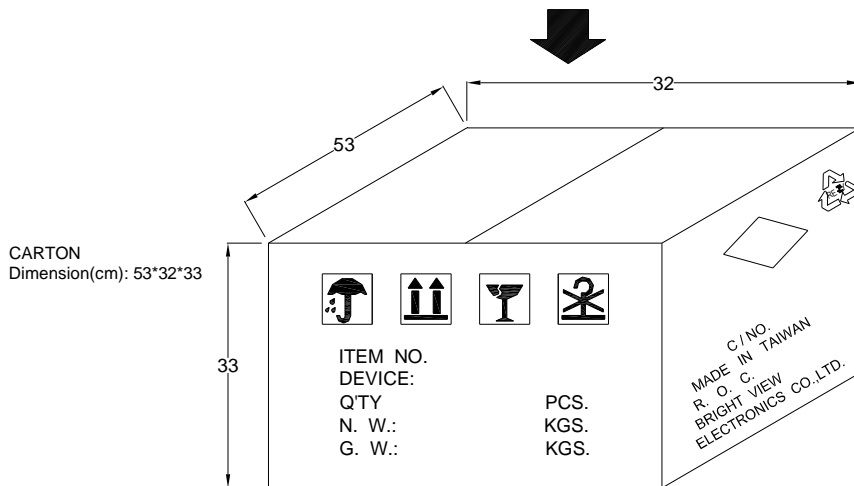

4 Boxes / Carton

5mm : 56,000pcs

3mm : 80,000pcs

Blue / Green / White : 36,000pcs