

\*Customer:

**Pb Free**

# SPECIFICATION

<b>ITEM</b>	<b>CHIP LED DEVICE</b>
<b>MODEL</b>	<b>BW104-S</b>
<b>REVISION DATE</b>	<b>Rev1.0(070102)</b>

## [Contents]

1. Features
2. Absolute maximum ratings
3. Electro-optical characteristics
4. Soldering profile
5. Outline dimension
6. Reel packing structure
7. Packing
8. Precaution for use
9. Label
10. Rank

## Customer

Approved by	Approved by	Approved by

## Supplier

Drawn by	Checked by	Approved by

## 1. Features

- Package : 1.6 × 0.8 × 0.4 mm
- Color coordinates: X = 0.21 Y = 0.16 according to CIE 1931
- Tape and reel packing

## 2. Absolute maximum ratings

(Ta=25°C)

Parameter	Symbol	Value	Unit
Power Dissipation	$P_d$	99	mW
Forward Current	$I_F$	30	mA
Peak Forward Current	$I_{FM}^{*1}$	100	mA
Reverse Voltage	$V_R$	5	V
Operating Temperature	$T_{opr}$	-30 ~ 80	°C
Storage Temperature	$T_{stg}$	-40 ~ 100	°C

\*1  $I_{FM}$  conditions: Pulse width  $T_w \leq 0.1ms$ , Duty ratio  $\leq 1/10$

## 3. Electro-optical characteristics

(Ta=25°C)

Characteristics	Symbol	Condition	Min	Typ	Max	Unit
Forward Voltage	$V_F$	$I_F=5mA$	2.7	2.9	3.1	V
Reverse Current	$I_R$	$V_R=5V$	-	-	10	$\mu A$
Luminous Intensity <sup>*2</sup>	$I_V$	$I_F=5mA$	25	45	81	mcd
Chromaticity Coordinates <sup>*3</sup>	X	$I_F=5mA$	0.165	0.210	0.260	
	Y	$I_F=5mA$	0.115	0.160	0.205	
Viewing Angle : Y Direction	$\Delta 1/2\theta$	$I_F=5mA$	-	$Y = \pm 80$	-	°

\*2 The luminous intensity  $I_V$  is measured at the peak of the spatial pattern which may not be aligned with the mechanical axis of the LED package.

\*3 The CIE standard colorimetric system

[Note] (Tolerance :  $IV \pm 10\%$ , color coordinate  $\pm 0.01$ ,  $V_F \pm 0.1$ )

#### 4. Soldering profile

##### Reflow Soldering Conditions/ Profile

###### (1) Lead Solder

-Preliminary heating to be at  $150^\circ\text{C}$  max. for 2 minutes max.

-Soldering heat to be at  $240^\circ\text{C}$  max. for 5 seconds max.

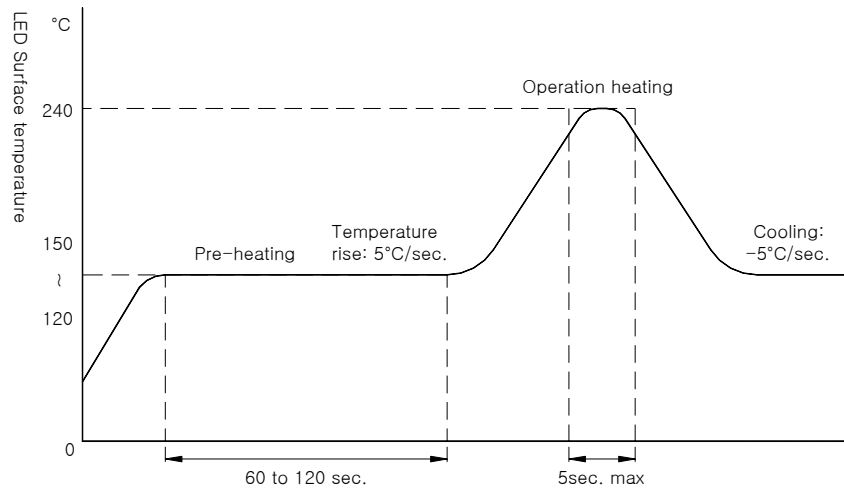

###### (2) Lead-Free Solder

-Preliminary heating to be at  $150^\circ\text{C}$  max. for 2 minutes max.

-Soldering heat to be at  $260^\circ\text{C}$  max. for 10 seconds max.

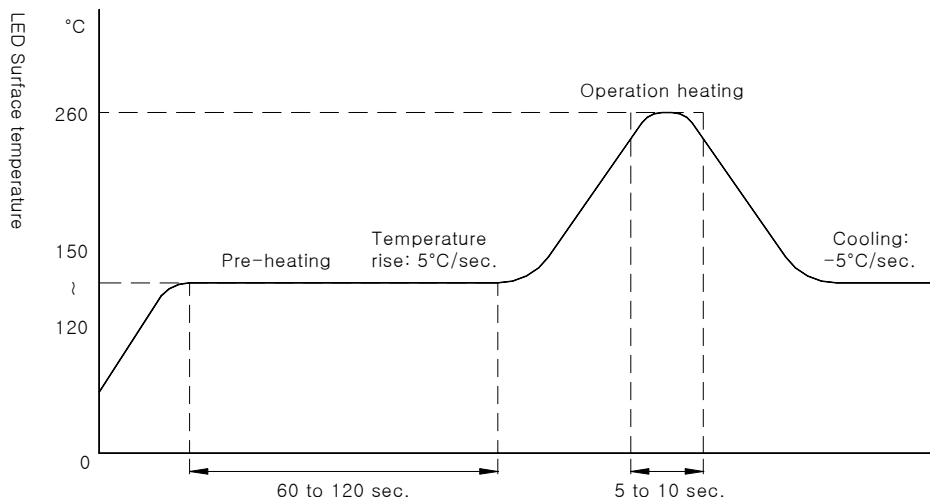

###### (3) Hand Solder

SSC-QP-0401-06(REV.0)

SEOUL SEMICONDUCTOR CO., LTD.  
148-29 Kasan-Dong, Keumchun-Gu, Seoul, Korea  
TEL: 82-2-3281-6269 FAX: 82-2-858-5537

SSC-BW104-S

-Not more than 3 seconds @MAX280°C, under Soldering iron.

### 5. Outline dimension

Tolerance:  $\pm 0.1$ , Unit: mm

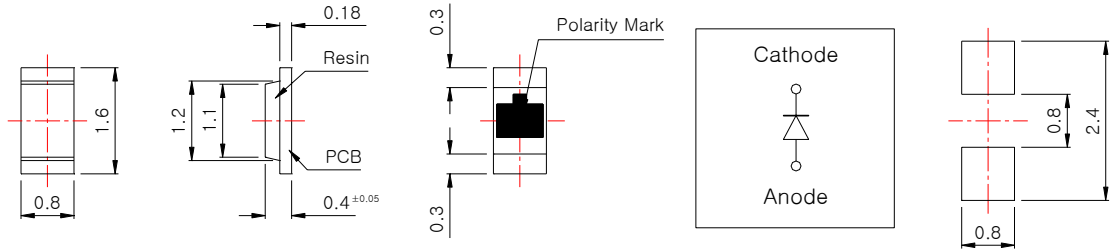

[Recommended Solder Pattern]

### 6. Reel packing structure

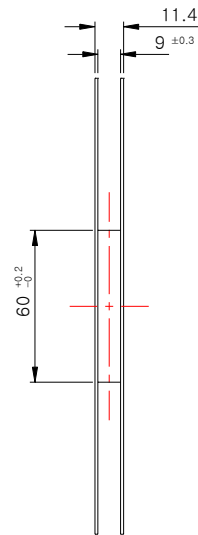
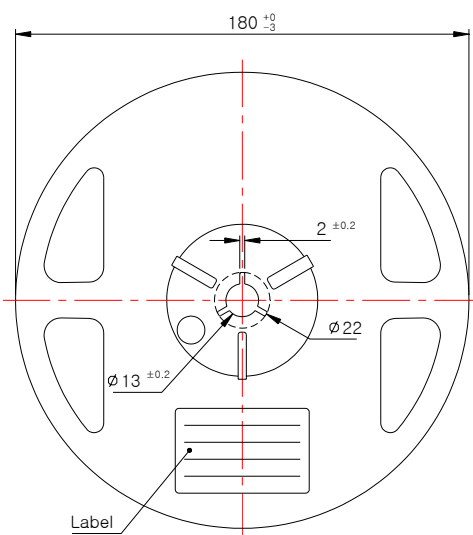
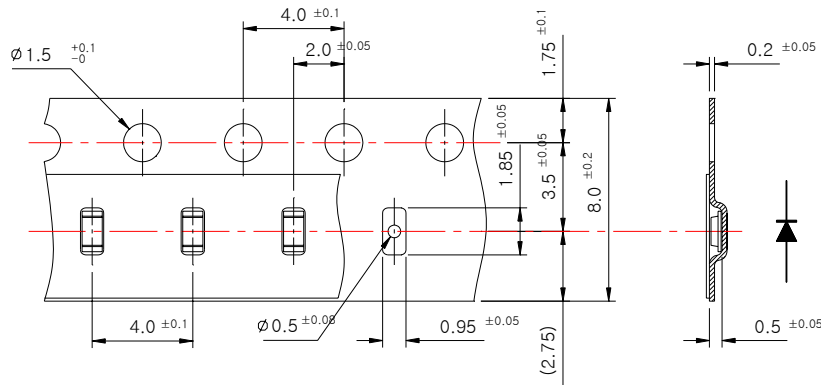

Tolerance  $\pm 0.2$ , Unit: mm

- (1) Quantity : 4000pcs/Reel
- (2) Cumulative Tolerance : Cumulative Tolerance/10 pitches to be  $\pm 0.2$ mm
- (3) Adhesion Strength of Cover Tape : Adhesion strength to be 0.1-0.7N when the cover tape is turned off from the carrier tape at 10°C angle to be the carrier tape

(4) Package : P/N, Manufacturing data Code No. and quantity to be indicated on a damp proof Package.

**7. Packing**

Reel

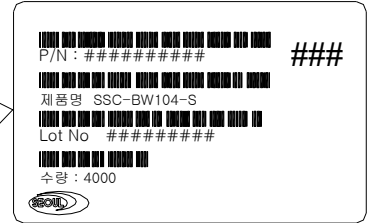
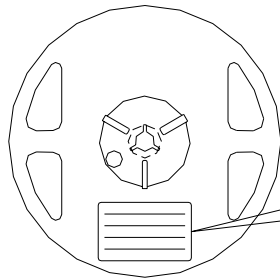

Aluminum Vinyl Bag

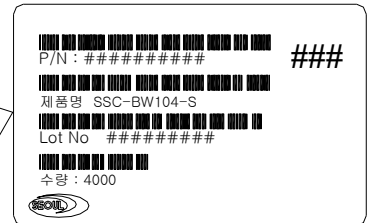
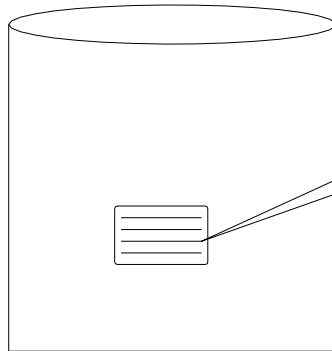

Outer Box

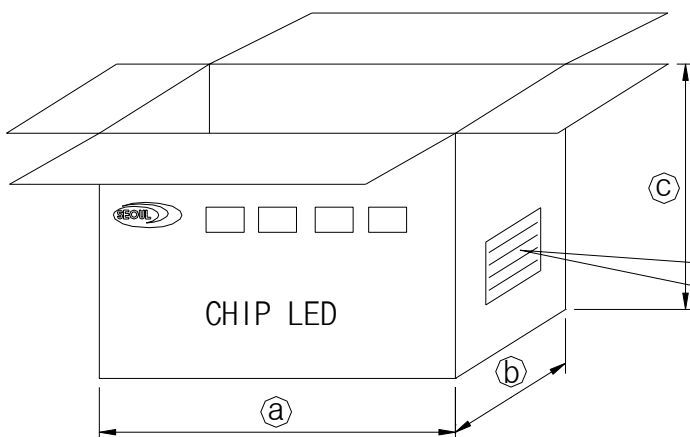

\*Material : Paper(SW3B(B))

TYPE	SIZE(mm)		
	a	b	c
7inch	245	220	142

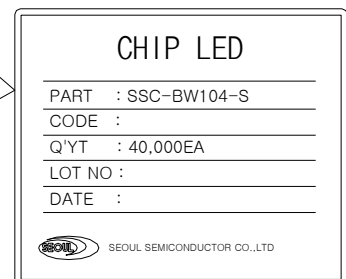

**8. Precaution for use**

(1) Storage

In order to avoid the absorption of moisture, it is recommended to store in the dry box (or desiccator) with a desiccant . Otherwise, to store them in the following environment is recommended.

Temperature : 5℃~30℃      Humidity : 60%HR max.

(2) Attention after opened

However LED is correspond SMD, when LED be reflowed, interfacial separation may affect the light transmission efficiency, causing the light intensity to drop. Attention in followed.

a. After opened and mounted, the soldering shall be quickly.

b. Keeping of a fraction

Temperature : 5 ~ 40℃      Humidity : less than 30%

(3) In case of more than 1 week passed after opening or change color of indicator on desiccant components shall be dried 10-12hr. at 60±5℃ .

(4) In case of supposed the components is humid, shall be dried dip-solder just before.

100Hr at 80±5℃ or 12Hr at 100±5℃ .

(5) Any mechanical force or any excess vibration shall not be accepted to apply during cooling process to normal temp. after soldering.

(6) Quick cooling shall not be avoid.

(7) Components shall not be mounted on warped direction of PCB.

(8) Anti radioactive ray design is not considered for the products listed here in.

(9) This device should not be used in any type of fluid such as water, oil, organic solvent and etc. When washing is required, IPA should be used.

(10) When the LEDs are illuminating, operating current should be decided after considering the ambient maximum temperature.





(11) LEDs must be stored to maintain a clean atmosphere. If the LEDs are stored for 3 months or more after being shipped from SSC, a sealed container with a nitrogen atmosphere should be used for storage.

(12) The LEDs must be soldered within seven days after opening the moisture-proof packing.

(13) Repack unused products with anti-moisture packing, fold to close any opening and then store in a dry place.

(14) The appearance and specifications of the product may be modified for improvement without notice.

**9. Label**

  
 P/N : #####  
  
 제품명 SSC-BW104-S  
  
 Lot No CAA050704#####-##  
  
 수량 : 4000  

###

Rank

Day

Month

Year

**10. Rank**



**1) Luminous Intensity : Iv [mcd]**

Rank	Iv [mcd]	Condition
A	25~45	IF =5mA
B	45~81	

**2) Color Coordinate : x, y**

Rank	R				Condition
x	0.167	0.184	0.219	0.202	IF=5mA
y	0.115	0.145	0.145	0.115	

Rank	S				Condition
x	0.184	0.202	0.237	0.219	IF=5mA
y	0.145	0.175	0.175	0.145	

Rank	T				Condition
x	0.202	0.221	0.256	0.237	IF=5mA
y	0.175	0.205	0.205	0.175	

**3) Voltage : VF[V]**

Rank	VF (V)		Condition
A	2.7	2.8	IF = 5mA
B	2.8	2.9	
C	2.9	3.0	
D	3.0	3.1	

◆ Rank Division

<b>Iv [mcd] (I<sub>F</sub>=5 mA)</b>	<b>Color coordinate (I<sub>F</sub>=5 mA)</b>	<b>VF [V] (I<sub>F</sub>=5 mA)</b>	<b>Rank</b>
A	R	A	ARA
A	R	B	ARB
A	R	C	ARC
A	R	D	ARD
A	S	A	ASA
A	S	B	ASB
A	S	C	ASC
A	S	D	ASD
A	T	A	ATA
A	T	B	ATB
A	T	C	ATC
A	T	D	ATD
B	R	A	BRA
B	R	B	BRB
B	R	C	BRC
B	R	D	BRD
B	S	A	BSA
B	S	B	BSB
B	S	C	BSC
B	S	D	BSD
B	T	A	BTA
B	T	B	BTB
B	T	C	BTC
B	T	D	BTD