

G. Fast Transformer - 106 MHz

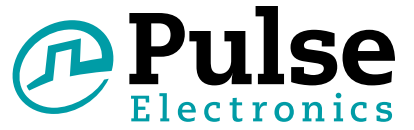

- G. Fast Transformer - 106MHz
- Compatible with Skipio's DFE and AFE chipsets.
- EN60950-1 Functional Isolation Compliant - 250Vrms
- RoHS-6 Compliant SMD Product
- Available on Tape and Reel

Electrical Specifications @ 25°C - Operating Temperatures @ -40°C to +85°C

Part Number	OCL (1-3) 100KHz, 10mV (uH Min)	Turns Ratio (1-3):(6-4) 15.75KHz, 100mV +/-2%	Leakage Inductance (1-3) with (4-6) shorted, 100KHz, 10mV (uH Max)	CWW Pri to Sec 100KHz, 100mV (pF Max)	DCR (1-3) (Ω Max)	DCR (4-6) (Ω Max)	IL 1MHz to 106MHz (dB Max)	Isolation Voltage (Pri to Sec) (Vrms, 2 secs)
BX4503NL*	60	1.25 : 1	0.3	10	0.3	0.19	1.0	1500
BX4504NL*	60	1.25 : 1	0.3	10	0.3	0.19	1.0	1500
BX4506NL*	60	1CT : 1CT	0.3	10	0.3	0.19	1.0	1500

* To order on tape and reel, place a "T" after the part number i.e. BX4503NLT, BX4504NLT, or BX4506NLT.

Mechanicals

Schematics

BX4503NL

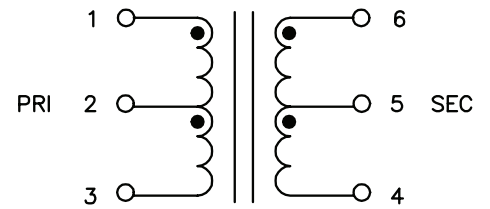
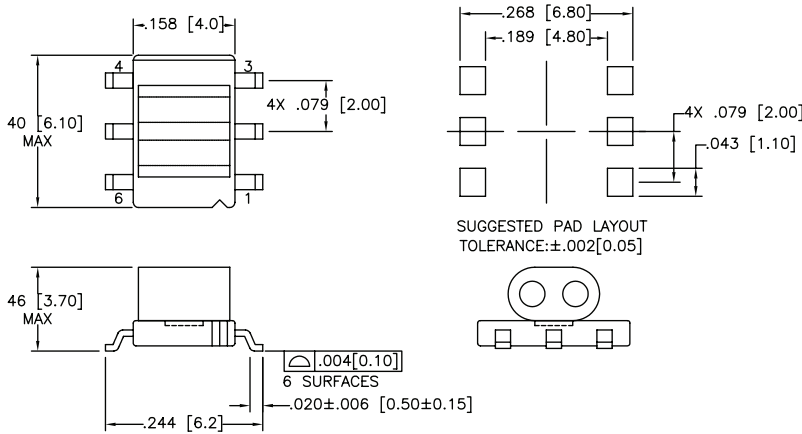

Dimensions: Inches [mm]. Tolerance: .XX
±.010 [0.25]; .XXX ±0.008 [0.20].

Pan Size: 140pcs/Tray; 850pcs/Tape & Reel.

BX4504NL

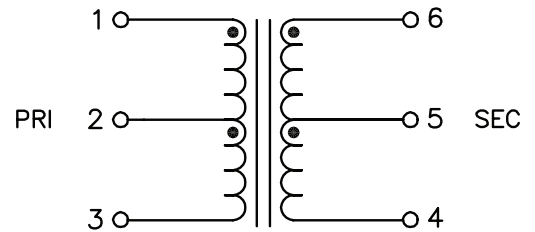
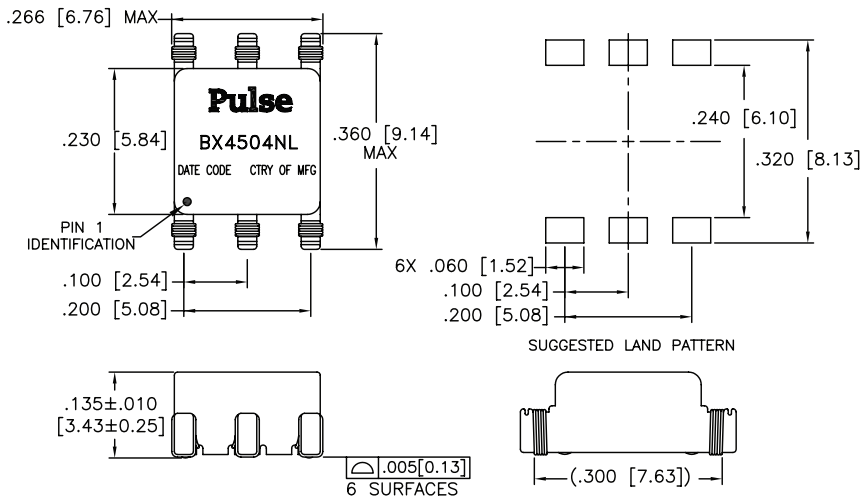

Dimensions: Inches [mm]. Tolerance: .XX
+/- .010 [0.25]; .XXX +/- 0.005 [0.13].

Pan Size: 60pcs/Tray; 800pcs/Tape & Reel.

G. Fast Transformer - 106 MHz

Mechanicals

Schematics

BX4506NL

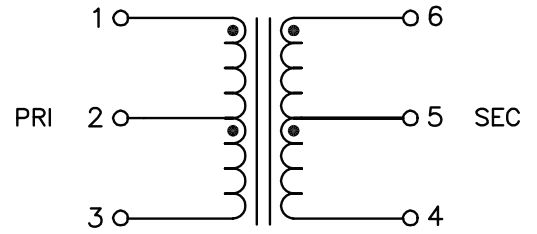
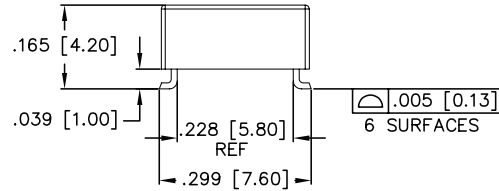
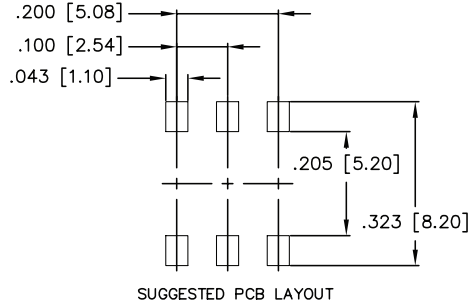
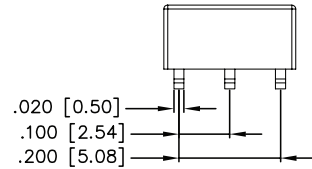
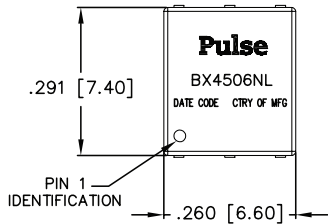

Dimensions: Inches [mm]. Tolerance: .XX
+/- .010 [0.25]; .XXX +/- 0.005 [0.13].

Pan Size: 60pcs/Tray; 800pcs/Tape & Reel.

Pulse Part Number	Sckipio DFE	Sckipio AFE
BX4503NL	SCK1001	SCK1002
BX4504NL	SCK1001	SCK1002
BX4506NL	SCK3001	SCK1002

For More Information

Pulse Worldwide Headquarters
12220 World Trade Drive
San Diego, CA
92128
U.S.A.

Tel: 858 674 8100
Fax: 858 674 8262

Pulse Europe
Einsteinstrasse 1
D-71083 Herrenberg
Germany

Tel: 49 7032 78060
Fax: 49 7032 7806 135

Pulse China Headquarters
B402, Shenzhen Academy of
Aerospace Technology Bldg.
10th Kejinan Road
High-Tech Zone
Nanshan District
Shenzen, PR China
518057
Tel: 86 755 33966678
Fax: 86 755 33966700

Pulse North China
Room 2704/2705
Super Ocean Finance
Ctr.
2067 Yan An Road
West
Shanghai 200336
China
Tel: 86 21 62787060
Fax: 86 2162786973

Pulse South Asia
135 Joo Seng Road
#03-02
PM Industrial Bldg.
Singapore 368363
Tel: 65 6287 8998
Fax: 65 6287 8998

Pulse North Asia
3F, No. 198
Zhongyuan Road
Zhongli City
Taoyuan County 320
Taiwan R. O. C.
Tel: 886 3 4356768
Fax: 886 3 4356823 (Pulse)
Fax: 886 3 4356820 (FRE)

Performance warranty of products offered on this data sheet is limited to the parameters specified. Data is subject to change without notice. Other brand and product names mentioned herein may be trademarks or registered trademarks of their respective owners. © Copyright, 2016. Pulse Electronics, Inc. All rights reserved.