

BY448

**SINTERED GLASS JUNCTION
AVALANCHE RECTIFIER**

VOLTAGE:1500V

CURRENT: 2.0A



FEATURE

Glass passivated
High maximum operating temperature
Low leakage current
Excellent stability

MECHANICAL DATA

Case: SOD-57 sintered glass case
Terminal: Plated axial leads solderable per MIL-STD 202E,
method 208C
Polarity: color band denotes cathode end
Mounting position: any

SOD-57

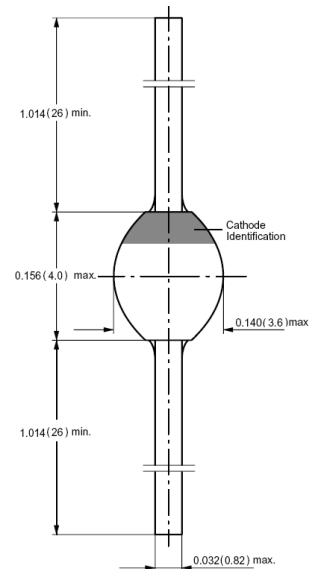

Dimensions in inches and (millimeters)

MAXIMUM RATINGS AND ELECTRICAL CHARACTERISTICS

(single-phase, half-wave, 60HZ, resistive or inductive load rating at 25°C, unless otherwise stated, for capacitive load, derate current by 20%)

	SYMBOL	BY448	units
Maximum Repetitive Peak Reverse Voltage	V _{rrm}	1500	V
Maximum RMS Voltage	V _{rms}	1050	V
Maximum DC blocking Voltage	V _{dc}	1500	V
Maximum Average Forward Rectified Current	I _{f(av)}	2.0	A
Non-Repetitive Peak Forward Surge Current at tp=10ms half sinewave	I _{fsm}	30.0	A
Maximum Instantaneous Forward Voltage at 3.0A	V _f	1.60	V
Maximum DC Reverse Current Ta =25°C at rated DC blocking voltage Ta =150°C	I _r	5.0 150.0	μA
Typical Reverse Recovery Time (Note 1)	T _{rr}	2000	nS
Typical Thermal Resistance (Note 2)	R _{th(ja)}	100	K /W
Storage and Operating Junction Temperature	T _{stg} , T _j	-65 to +175	°C

Note:

1. Reverse Recovery Condition I_f =0.5A, I_r =1.0A, I_{rr} =0.25A
2. on PC with spacing 25mm

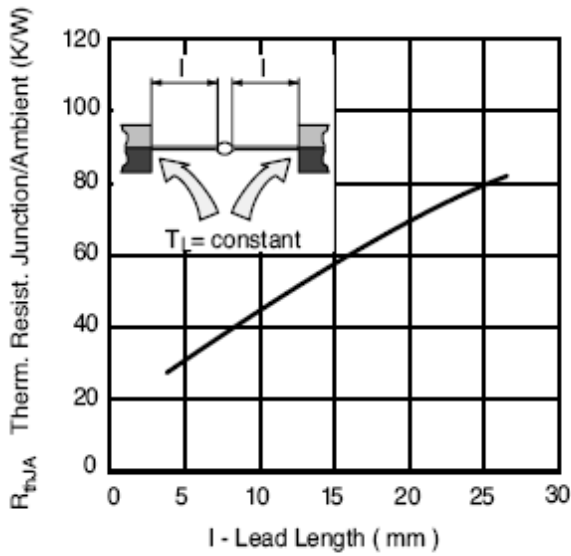

Figure 1. Typ. Thermal Resistance vs. Lead Length

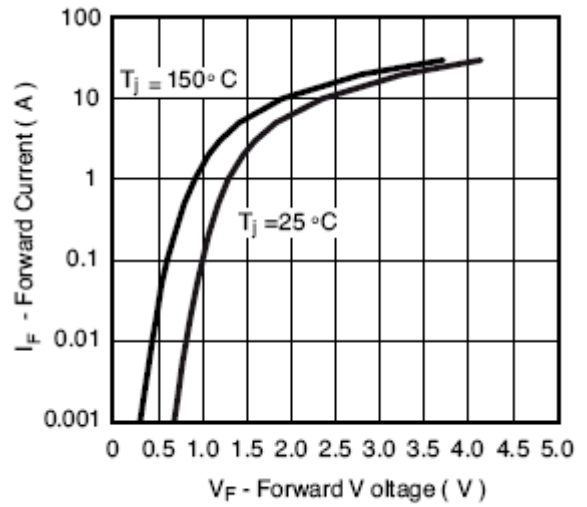

Figure 2. Forward Current vs. Forward Voltage

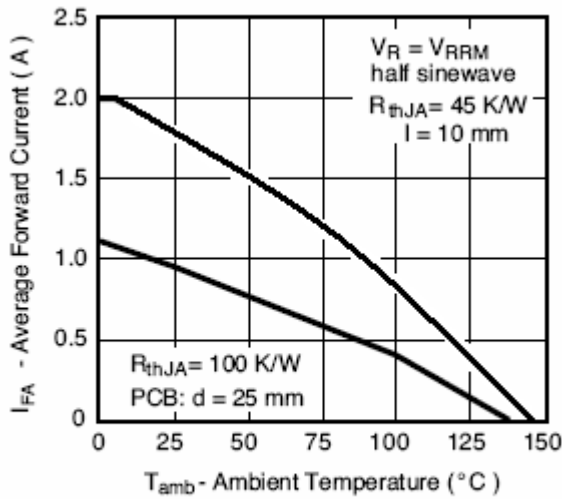

Figure 3. Max. Average Forward Current vs. Ambient Temperature

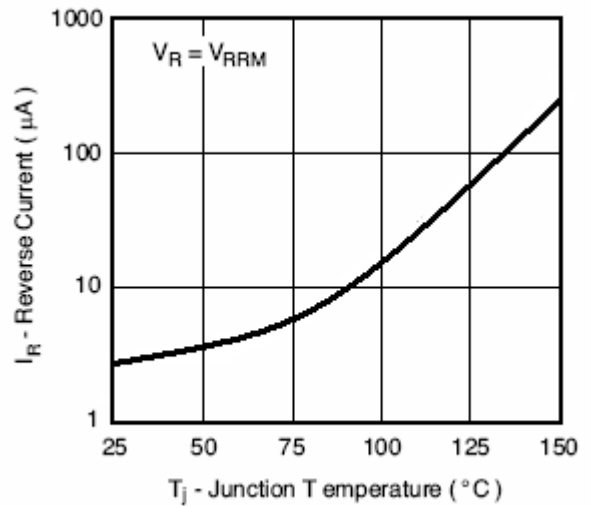

Figure 4. Reverse Current vs. Junction Temperature

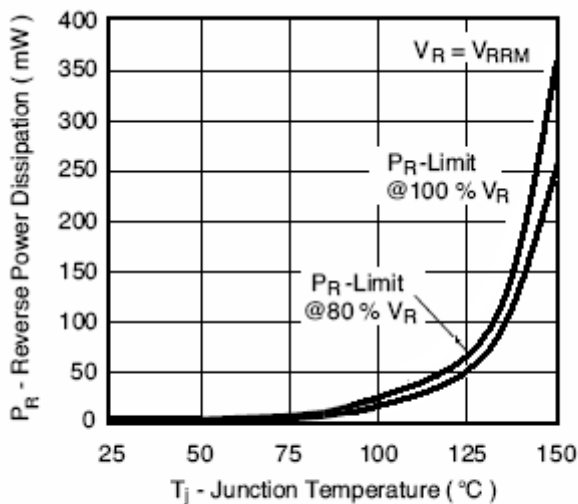

Figure 5. Max. Reverse Power Dissipation vs. Junction Temperature

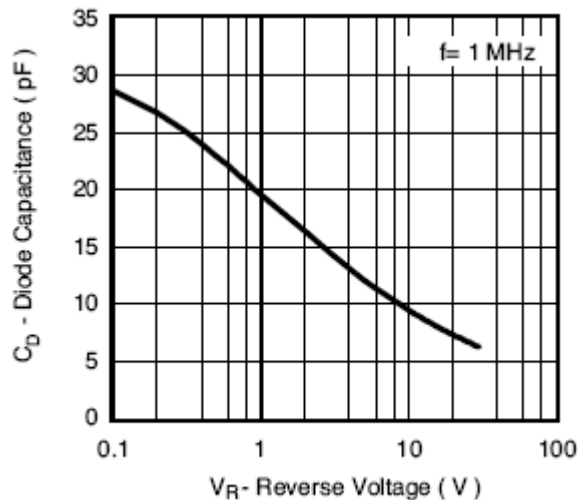

Figure 6. Diode Capacitance vs. Reverse Voltage