



BYC15

DIODE

RECTIFIER DIODE, HYPERFAST

DESCRIPTION

The UTC **BYC15** is a rectifier diode. It provides the designers with ultra-fast switching and low switching loss in associated MOSFET.

The UTC **BYC15** is suitable for half-bridge lighting ballasts, half-bridge/full-bridge switched mode power supplies and active power factor correction applications.

FEATURES

- * Low Reverse Recovery Current
- * Ultra-Fast Switching
- * Low Switching Loss in associated MOSFET
- * Low Thermal Resistance

SYMBOL

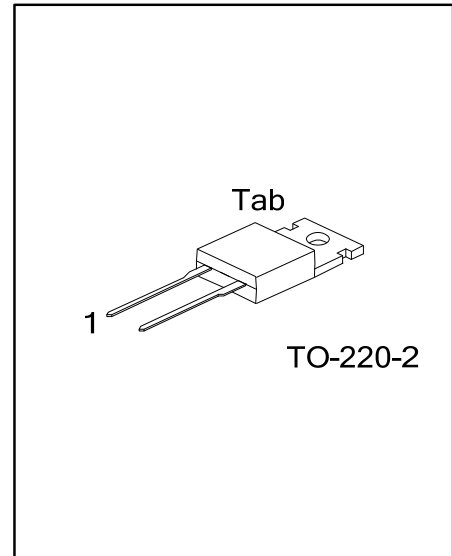
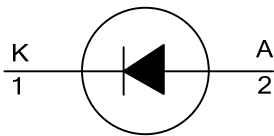

ORDERING INFORMATION

Ordering Number		Package	Pin Assignment			Packing
Lead Free	Halogen Free		1	2	Tab	
BYC15L-6-TA2-T	BYC15G-6-TA2-T	TO-220-2	K	A	K	Tube

Note: Pin Assignment: A: Anode K: Cathode Tab: Mounting Base

BYC15G-6-TA2-T	(1)Packing Type	(1) T: Tube
	(2)Package Type	(2) TA2: TO-220-2
	(3)Green Package	(3) G: Halogen Free and Lead Free, L: Lead Free

MARKING

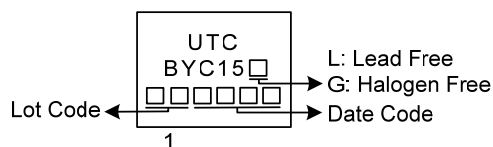

■ ABSOLUTE MAXIMUM RATINGS

PARAMETER	SYMBOL	RATINGS	UNIT	
Peak Repetitive Reverse Voltage	V_{RRM}	600	V	
Crest Working Reverse Voltage	V_{RWM}	600	V	
Reverse Voltage	square-wave pulse; $\delta = 1.0$; $T_{Tab} \leq 100^{\circ}\text{C}$	V_R	500	V
Average Forward Current	square-wave pulse; $\delta = 0.5$; $T_{Tab} \leq 98^{\circ}\text{C}$	$I_{F(AV)}$	15	A
Repetitive Peak Forward Current	square-wave pulse; $\delta = 0.5$; $t_P = 25\mu\text{s}$, $T_{Tab} \leq 98^{\circ}\text{C}$	I_{FRM}	30	A
Non-Repetitive Peak Forward Current.	$t_P = 10\text{ms}$, sine-wave pulse;	I_{FSM}	200	A
	$t_P = 8.3\text{ms}$, sine-wave pulse;		220	A
Junction Temperature	T_J	+150	$^{\circ}\text{C}$	
Storage Temperature	T_{STG}	-40 ~ +150	$^{\circ}\text{C}$	

Note: Absolute maximum ratings are those values beyond which the device could be permanently damaged. Absolute maximum ratings are stress ratings only and functional device operation is not implied.

■ THERMAL DATA

PARAMETER	SYMBOL	RATINGS	UNIT
Junction to Ambient	θ_{JA}	60	K/W
Junction to Tab	θ_{JB}	1.5	K/W

■ ELECTRICAL CHARACTERISTICS ($T_J = 25^{\circ}\text{C}$, unless otherwise specified)

PARAMETER	SYMBOL	TEST CONDITIONS	MIN	TYP	MAX	UNIT
Forward Voltage	V_F	$I_F = 15\text{A}$			2.9	V
Reverse Current	I_R	$V_R = 600\text{V}$			200	μA
Reverse Recovery Time	t_{RR}	$I_F = 1\text{A}$, $V_R = 30\text{V}$, $dI_F/dt = 50\text{A}/\mu\text{s}$ (Figure1)		90		ns
		$I_F = 15\text{A}$, $V_R = 400\text{V}$, $dI_F/dt = 300\text{A}/\mu\text{s}$ (Figure1)		117		ns
Forward Recovery Voltage	V_{FR}	$I_F = 15\text{A}$, $dI_F/dt = 100\text{A}/\mu\text{s}$ (Figure2)		8	11	V

■ TYPICAL CHARACTERISTICS

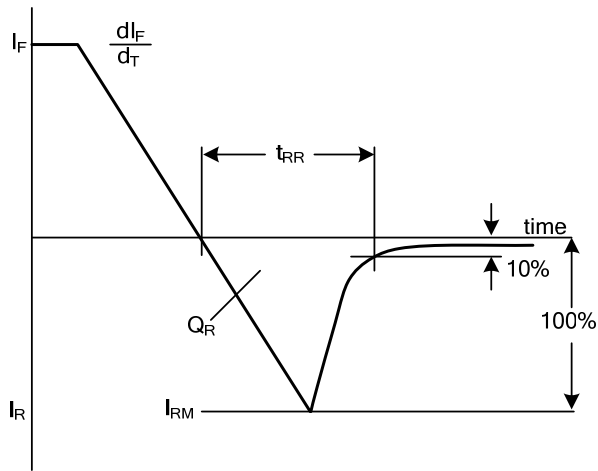

Fig 1. Reverse Recovery Definitions

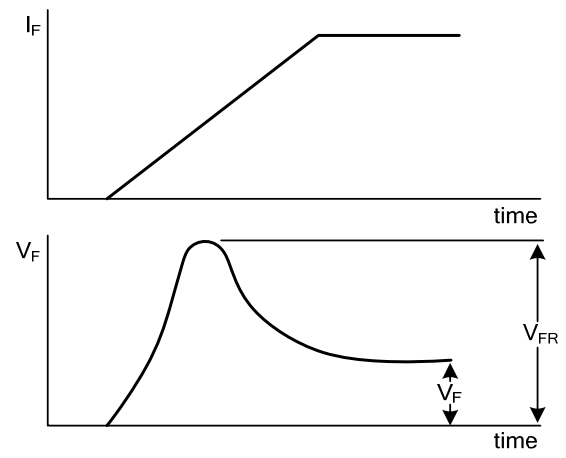
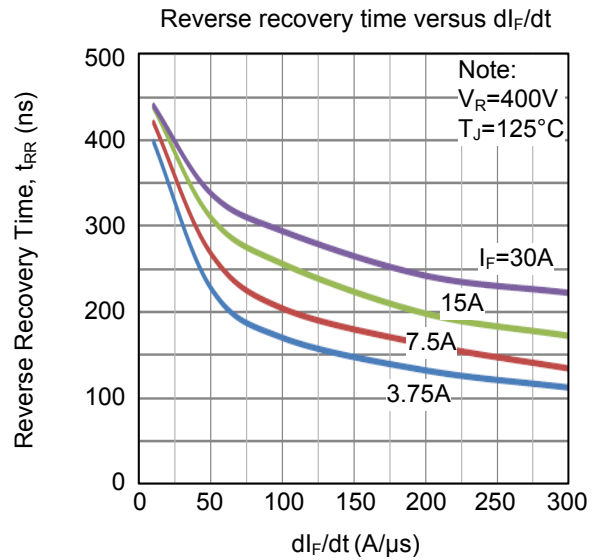
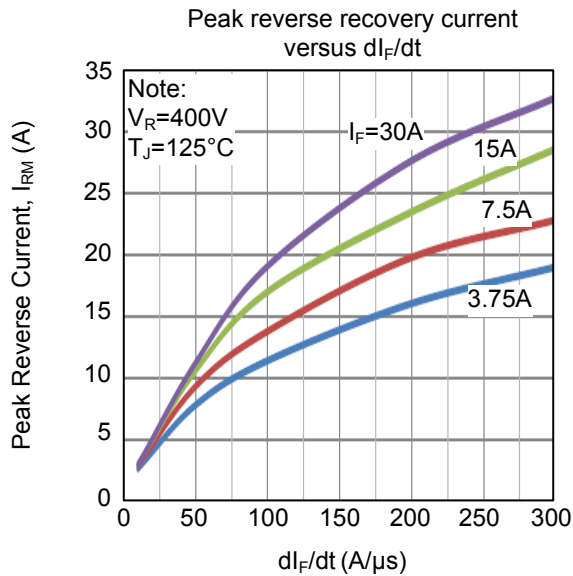

Fig 2. Forward Recovery Definitions

■ TYPICAL CHARACTERISTICS



UTC assumes no responsibility for equipment failures that result from using products at values that exceed, even momentarily, rated values (such as maximum ratings, operating condition ranges, or other parameters) listed in products specifications of any and all UTC products described or contained herein. UTC products are not designed for use in life support appliances, devices or systems where malfunction of these products can be reasonably expected to result in personal injury. Reproduction in whole or in part is prohibited without the prior written consent of the copyright owner. UTC reserves the right to make changes to information published in this document, including without limitation specifications and product descriptions, at any time and without notice. This document supersedes and replaces all information supplied prior to the publication hereof.