

EPITAXIAL AVALANCHE DIODES

Glass passivated rectifier diodes in hermetically sealed axial-leaded ID* envelopes. They feature low forward voltage drop, very fast recovery, very low stored charge, non-snap-off switching characteristics and are capable of absorbing reverse transient energy (e.g. during flashover in a picture tube). These properties make the diodes very suitable for use in switched-mode power supplies and in general high-frequency circuits, where low conduction and switching losses are essential.

QUICK REFERENCE DATA

		BDY74A	B	C	D	E	F	G	
Repetitive peak reverse voltage	V_{RRM}	max. 50	100	150	200	250	300	400	V
Continuous reverse voltage	V_R	max. 50	100	150	200	250	300	400	V
Average forward current	$I_{F(AV)}$	max. 2,4	2,4	2,4	2,4	2,15	2,15	2,15	A
Non-repetitive peak forward current	I_{FSM}	max. 50	50	50	50	50	50	50	A
Non-repetitive peak reverse energy	E_{RSM}	max. 40	40	40	40	40	40	40	mJ
Reverse recovery time	t_{rr}	< 25	25	25	25	50	50	50	ns

MECHANICAL DATA

Dimensions in mm

Fig. 1 SOD-84.

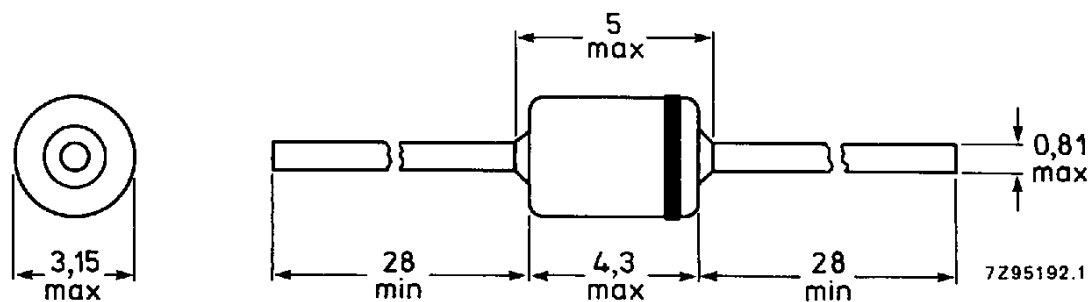

The marking band indicates the cathode.

* Implosion diode.

RATINGS

Limiting values in accordance with the Absolute Maximum System (IEC 134)

		BYD74A	B	C	D	E	F	G
Repetitive peak reverse voltage	V_{RRM}	max. 50	100	150	200	250	300	400 V
Continuous reverse voltage	V_R	max. 50	100	150	200	250	300	400 V
Average forward current square wave; $\delta = 0,5$ $T_{tp} = 55\text{ }^\circ\text{C}$; lead length = 10 mm $T_{amb} = 60\text{ }^\circ\text{C}$; Fig. 2	$I_{F(AV)}$	max. 2,4	2,4	2,4	2,4	2,15	2,15	2,15 A
	$I_{F(AV)}$	max. 1,35	1,35	1,35	1,35	1,2	1,2	1,2 A
Repetitive peak forward current $T_{tp} = 55\text{ }^\circ\text{C}$; see Figs 11 and 13 $T_{amb} = 60\text{ }^\circ\text{C}$; see Figs 12 and 14	I_{FRM}	max. 21	21	21	21	21	21	21 A
	I_{FRM}	max. 13	13	13	13	12	12	12 A
Non-repetitive peak forward current ($t = 10\text{ ms}$; half sine-wave) $T_j = T_{j\text{ max}}$ prior to surge; with reapplied V_{RRM}	I_{FSM}	max.			50			A
Non-repetitive peak reverse avalanche energy; with inductive load switched-off: $I_R = 820\text{ mA}$ at $T_j = 25\text{ }^\circ\text{C}$ prior to surge	E_{RSM}	max.			40			mJ
$I_R = 580\text{ mA}$ at $T_j = T_{j\text{ max}}$ prior to surge	E_{RSM}	max.			20			mJ
Storage temperature	T_{stg}		-65 to + 175					$^\circ\text{C}$
Junction temperature	T_j	max.			175			$^\circ\text{C}$

THERMAL RESISTANCE

Influence of mounting method

1. Thermal resistance from junction to tie-point at a lead length of 10 mm
2. Thermal resistance from junction to ambient when mounted on a 1,5 mm thick epoxy-glass printed-circuit board; Cu-thickness $\geq 40\text{ }\mu\text{m}$ (see "Thermal model")

$R_{th\ j-tp} = 50\text{ K/W}$

$R_{th\ j-a} = 105\text{ K/W}$

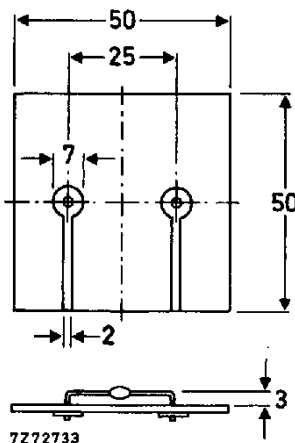
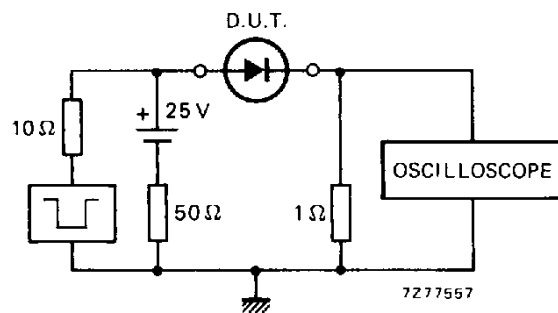

Fig. 2 Mounted on a printed-circuit board.

CHARACTERISTICS

$T_j = 25\text{ }^\circ\text{C}$ unless otherwise specified

	BYD74A	B	C	D	E	F	G
Reverse avalanche breakdown voltage $I_R = 0,1\text{ mA}$	$V_{(BR)R} > 55$	110	165	220	275	330	440 V
Forward voltage* $I_F = 2\text{ A}; T_j = T_{j\text{ max}}$	$V_F < 0,72$	0,72	0,72	0,72	0,82	0,82	0,82 V
$I_F = 2\text{ A}$	$V_F < 0,94$	0,94	0,94	0,94	1,05	1,05	1,05 V
Reverse current $V_R = V_{RRM\text{ max}}; T_j = 25\text{ }^\circ\text{C}$	$I_R < 1$	1	1	1	1	1	1 μA
$V_R = V_{RRM\text{ max}}; T_j = 165\text{ }^\circ\text{C}$	$I_R < 150$	150	150	150	150	150	150 μA
Reverse recovery time when switched from $I_F = 0,5\text{ A}$ to $I_R = 1\text{ A}$; measured at $I_R = 0,25\text{ A}$. For definition see Figs 3 and 4	$t_{rr} < 25$	25	25	25	50	50	50 ns



Input impedance oscilloscope $1\text{ M}\Omega; 22\text{ pF}$. Rise time $\leq 7\text{ ns}$.
Source impedance $50\text{ }\Omega$. Rise time $\leq 15\text{ ns}$.

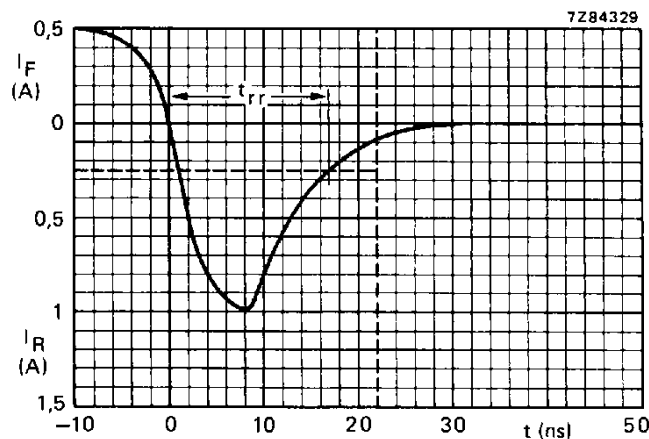

Fig. 4 Reverse recovery time characteristic.

* Measured under pulse conditions to avoid excessive dissipation.

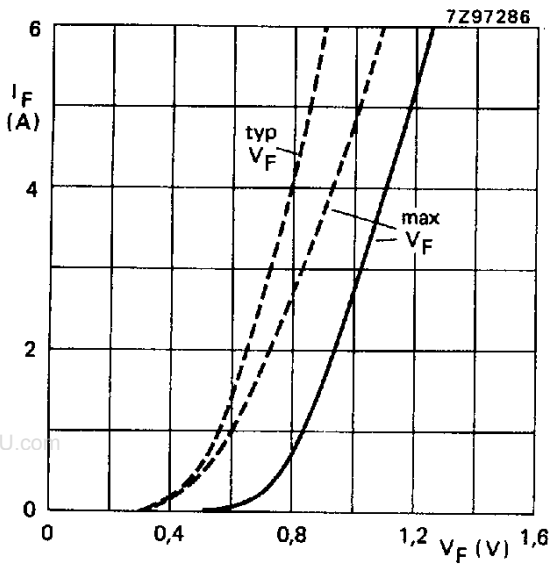

Fig. 5 BYD74A; B; C; D. Forward voltage;
 ——— $T_j = 25\text{ }^\circ\text{C}$; - - - $T_j = T_{j\text{ max}}$

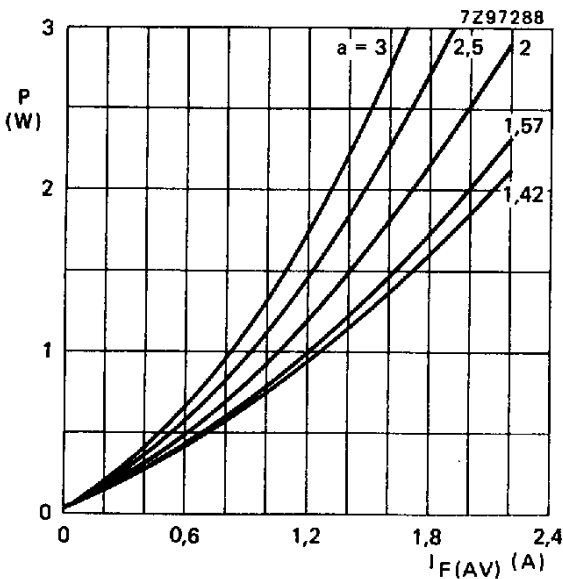

Fig. 6 BYD74A; B; C; D. Maximum values steady state power dissipation (forward plus leakage current) excluding switching losses as a function of the average forward current.

The graph is for switched-mode application.

$a = I_{F(RMS)}/I_{F(AV)}$; $V_R = V_{RRMmax}$, $\delta = 0,5$.

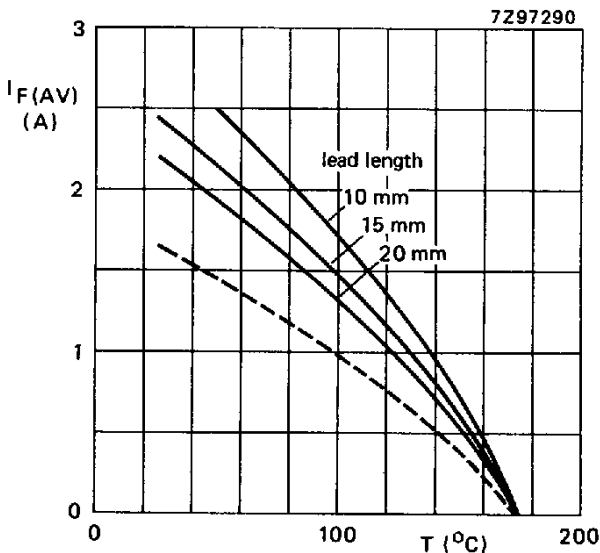

Fig. 7 BYD74A; B; C; D. Maximum average forward current as a function of temperature; the curves include losses due to reverse leakage.

The graph is for switched-mode application.

$V_R = V_{RRMmax}$, $\delta = 0,5$; $a = 1,42$.

- - - = ambient temperature and device mounted as shown in Fig. 2
- = tie-point temperature

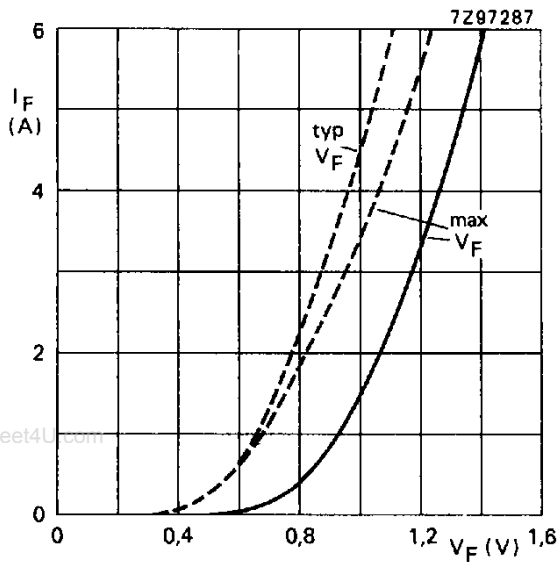

Fig. 8 BYD74E; F; G. Forward voltage;
 ——— $T_j = 25\text{ }^\circ\text{C}$; - - - $T_j = T_{j\text{ max}}$.

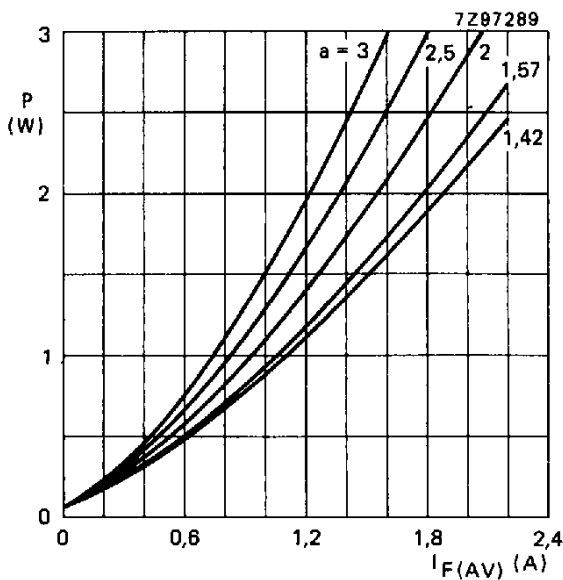

Fig. 9 BYD74E; F; G. Maximum values steady state power dissipation (forward plus leakage current) excluding switching losses as a function of the average forward current.

The graph is for switched-mode application.

$a = I_{F(RMS)}/I_{F(AV)}$; $V_R = V_{RRMmax}$, $\delta = 0,5$.

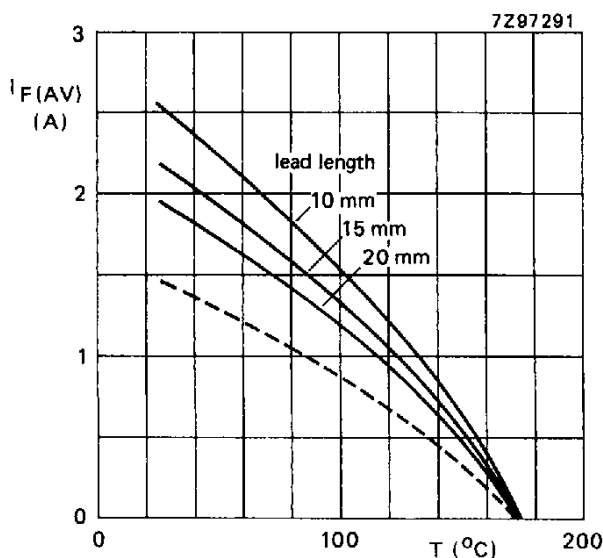

Fig. 10 BYD74E; F; G. Maximum average forward current as a function of temperature; the curves include losses due to reverse leakage.

The graph is for switched-mode application.

$V_R = V_{RRMmax}$, $\delta = 0,5$; $a = 1,42$.

- - - = ambient temperature and device mounted as shown in Fig. 2
- = tie-point temperature

7Z97293

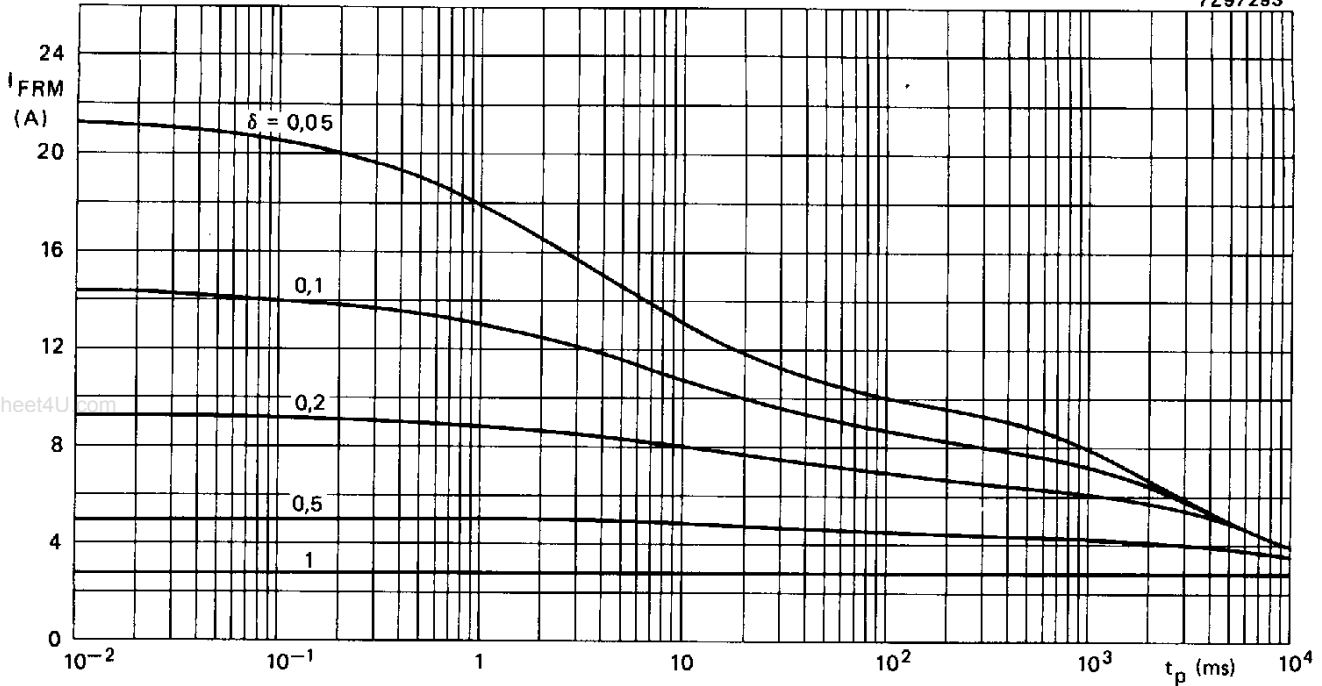

Fig. 11 BYD74A; B; C; D. Maximum repetitive peak forward current as a function of the pulse time (square pulse) and duty-factor δ at $T_{tie-point} = 55\text{ }^\circ\text{C}$; $R_{th\ j-tp} = 50\text{ K/W}$; V_{RRM} during $1 - \delta$; the curves include derating for $T_{j\ max}$ at $V_{RRM} = 200\text{ V}$.

7Z97295

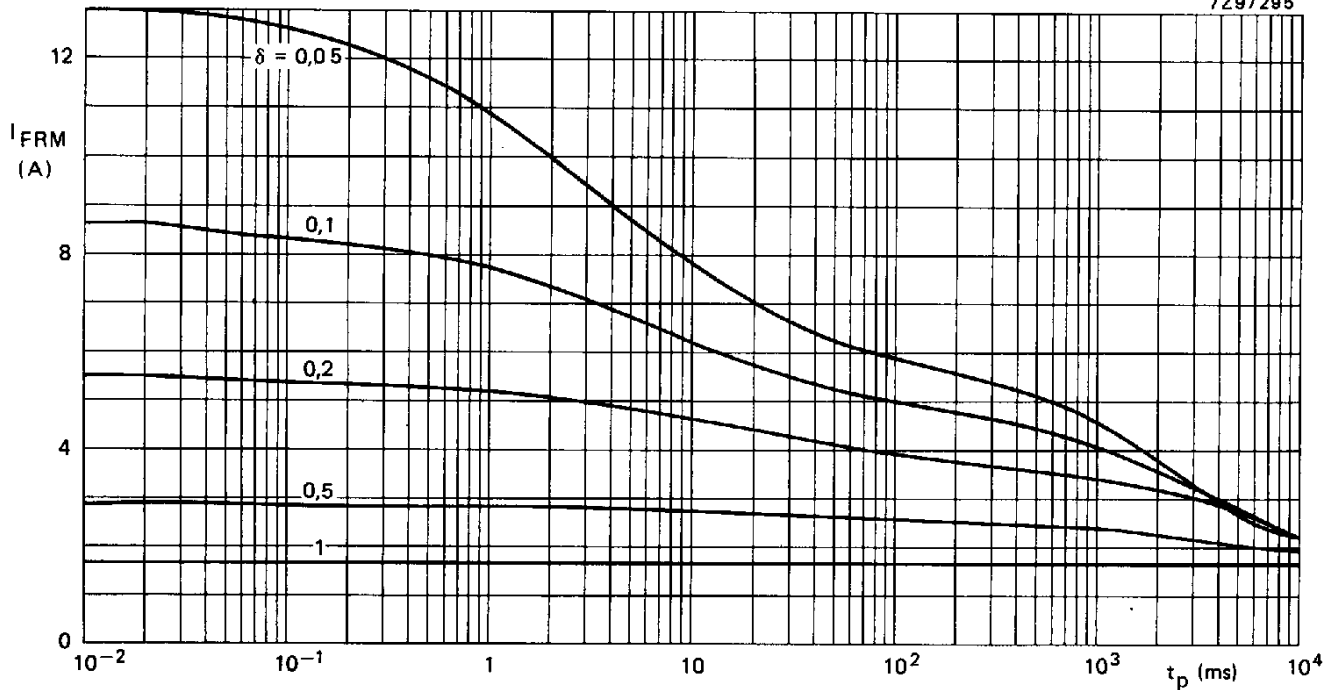

Fig. 12 BYD74A; B; C; D. Maximum repetitive peak forward current as a function of the pulse time (square pulse) and duty factor δ at $T_{amb} = 60\text{ }^\circ\text{C}$; $R_{th\ j-a} = 105\text{ K/W}$; V_{RRM} during $1 - \delta$; the curves include derating for $T_{j\ max}$ at $V_{RRM} = 200\text{ V}$.

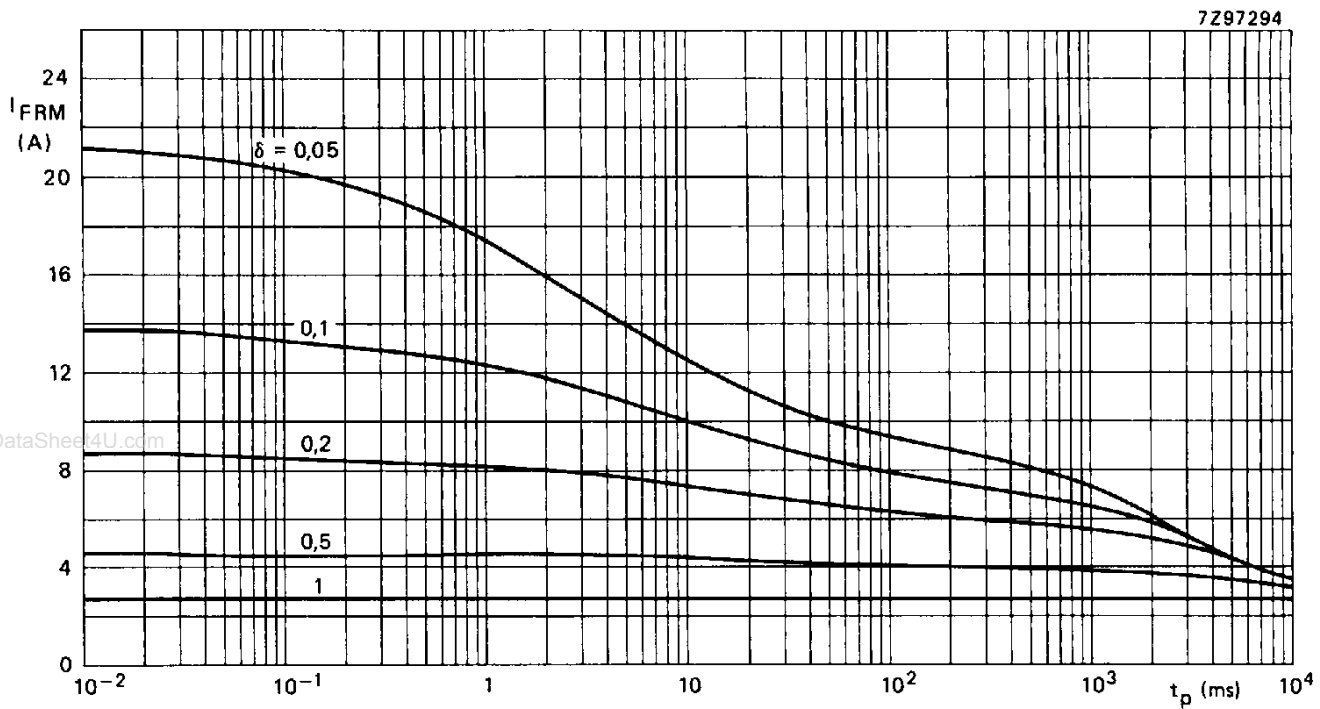

Fig. 13 **BYD74E; F; G.** Maximum repetitive peak forward current as a function of the pulse time (square pulse) and duty-factor δ at $T_{tie-point} = 55\text{ }^{\circ}\text{C}$; $R_{th\ j-tp} = 50\text{ K/W}$; V_{RRM} during $1 - \delta$; the curves include derating for $T_{j\ max}$ at $V_{RRM} = 400\text{ V}$.

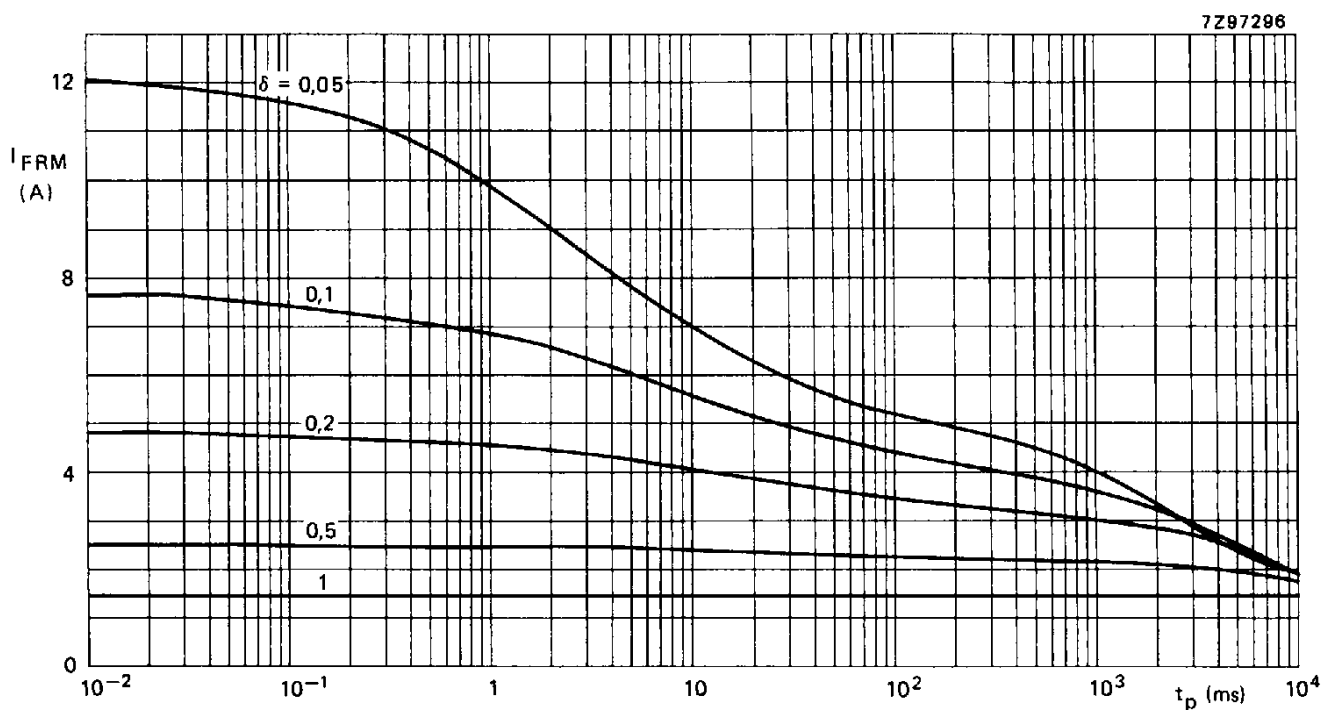

Fig. 14 **BYD74E; F; G.** Maximum repetitive peak forward current as a function of the pulse time (square pulse) and duty-factor δ at $T_{amb} = 60\text{ }^{\circ}\text{C}$; $R_{th\ j-a} = 105\text{ K/W}$; V_{RRM} during $1 - \delta$; the curves include derating for $T_{j\ max}$ at $V_{RRM} = 400\text{ V}$.

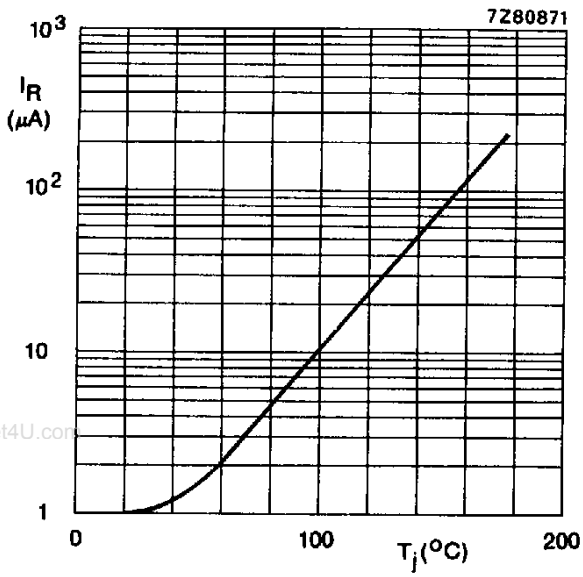

Fig. 15 Maximum values reverse current as a function of junction temperature; $V_R = V_{RRMmax}$.

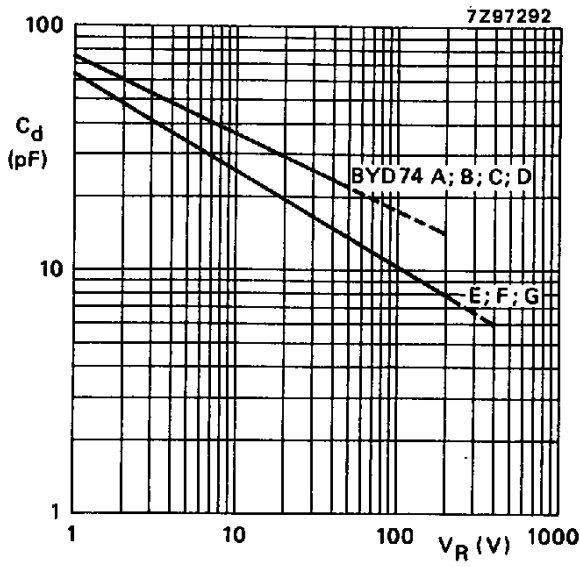

Fig. 16 Capacitance as a function of reverse voltage; $f = 1$ MHz; $T_j = 25$ °C; typical values.