

FRED Diode

- Fast recovery epitaxial diode
- Soft recovery characteristics

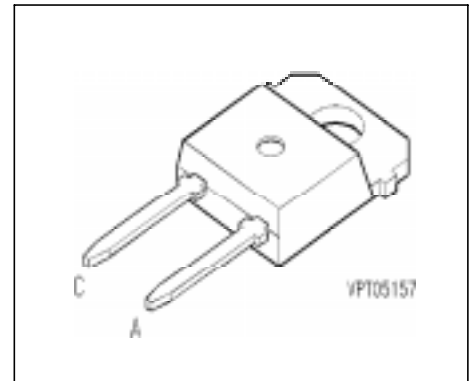

Type	V_{RRM}	I_{FRMS}	t_{rr}	Package	Ordering Code
BYP 302	1200V	40A	130ns	TO-218 AD	C67047-A2252-A2

Maximum Ratings

Parameter	Symbol	Values	Unit
Mean forward current $T_C = 90\text{ °C}, D = 0.5$	I_{FAV}	25	A
RMS forward current	I_{FRMS}	40	
Surge forward current, sine halfwave, aperiodic $T_j = 100\text{ °C}, f = 50\text{ Hz}$	I_{FSM}	115	
Repetitive peak forward current $T_j = 100\text{ °C}, t_p \leq 10\text{ }\mu\text{s}$	I_{FRM}	260	A ² s
i^2t value $T_j = 100\text{ °C}, t_p = 10\text{ ms}$	$\int I^2 dt$	66	
Repetitive peak reverse voltage	V_{RRM}	1200	V
Surge peak reverse voltage	V_{RSM}	1200	
Power dissipation $T_C = 90\text{ °C}$	P_{tot}	75	W
Chip or operating temperature	T_j	-40 ... + 150	°C
Storage temperature	T_{stg}	-40 ... + 150	
Thermal resistance, chip case	R_{thJC}	≤ 0.8	K/W
Thermal resistance, chip-ambient	R_{thJA}	≤ 46	
DIN humidity category, DIN 40 040	-	E	-
IEC climatic category, DIN IEC 68-1	-	40 / 150 / 56	-

Electrical Characteristics, at $T_j = 25\text{ °C}$, unless otherwise specified

Parameter	Symbol	Values			Unit
		min.	typ.	max.	

Static Characteristics

Forward voltage drop	V_F				V
$I_F = 15\text{ A}, T_j = 25\text{ °C}$		-	1.9	-	
$I_F = 25\text{ A}, T_j = 25\text{ °C}$		-	2.2	2.7	
$I_F = 15\text{ A}, T_j = 100\text{ °C}$		-	1.5	-	
$I_F = 25\text{ A}, T_j = 100\text{ °C}$	-	1.8	-		
Reverse current	I_R				mA
$V_R = 1200\text{ V}, T_j = 25\text{ °C}$		-	0.01	0.25	
$V_R = 1200\text{ V}, T_j = 100\text{ °C}$		-	0.05	-	
$V_R = 1200\text{ V}, T_j = 150\text{ °C}$		-	0.15	-	

AC Characteristics

Reverse recovery charge	Q_{rr}				μC
$I_F = 25\text{ A}, V_{CC} = 500\text{ V}, di_F/dt = -1000\text{ A}/\mu\text{s}$ $T_j = 100\text{ °C}$		-	4.5	-	
Peak reverse recovery current	I_{RRM}				A
$I_F = 25\text{ A}, V_{CC} = 500\text{ V}, di_F/dt = -1000\text{ A}/\mu\text{s}$ $T_j = 100\text{ °C}$		-	50	-	
Reverse recovery time	t_{rr}				ns
$I_F = 25\text{ A}, V_{CC} = 500\text{ V}, di_F/dt = -1000\text{ A}/\mu\text{s}$ $T_j = 100\text{ °C}$		-	130	-	
Storage time	t_S				
$I_F = 25\text{ A}, V_{CC} = 500\text{ V}, di_F/dt = -1000\text{ A}/\mu\text{s}$ $T_j = 100\text{ °C}$		-	65	-	
Softfaktor	S				-
$I_F = 25\text{ A}, V_{CC} = 500\text{ V}, di_F/dt = -1000\text{ A}/\mu\text{s}$ $T_j = 100\text{ °C}$		-	1	-	

Typ. forward characteristics

$$I_F = f(V_F)$$

parameter: T_j

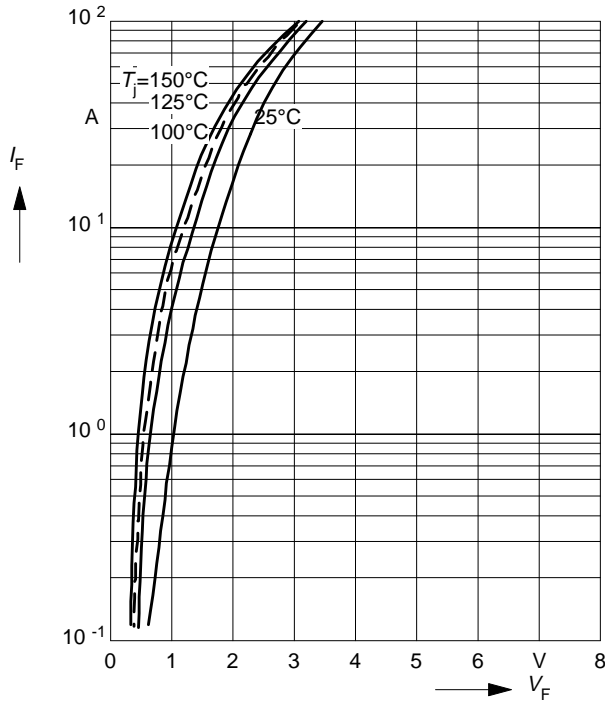

Typ. reverse current

$$I_{RRM} = f(dI_F / dt)$$

parameter: $V_{CC} = 500\text{ V}, I_F = 25\text{ A}, T_j = 100^\circ\text{C}$

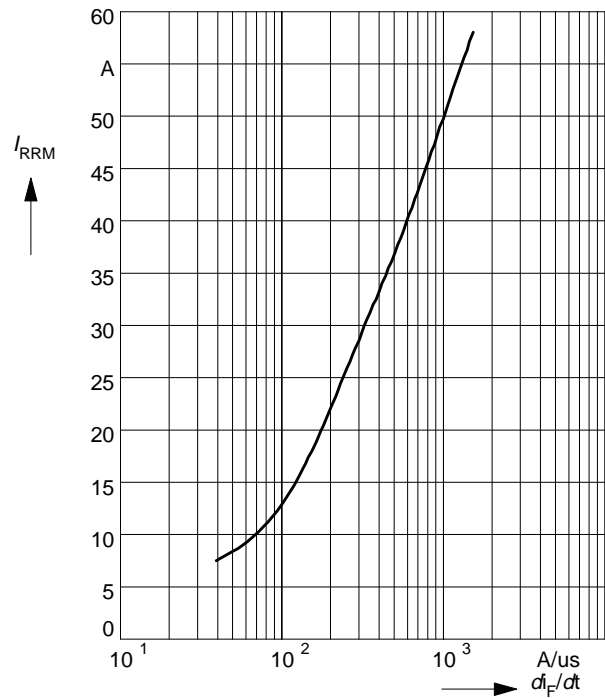

Typ. reverse recovery charge

$$Q_{rr} = f(dI_F / dt)$$

parameter: $V_{CC} = 500\text{ V}, I_F = 25\text{ A}, T_j = 100^\circ\text{C}$

