

Ultrafast Power Rectifiers

Dual high voltage rectifiers suited for Switchmode Power Supplies and other power converters.

- Very Low Reverse Recovery Time
- Very Low Switching Losses
- Low Noise Turn-Off Switching
- Insulated Package:
Insulating voltage = 2500 V_{RMS}
Capacitance = 45 pF
-  — UL Recognized, File #E69369

Mechanical Characteristics

- Case: Molded epoxy with isolated metal base
- Weight: 28 g (approximately)
- Finish: All External Surfaces Corrosion Resistant
- Shipped 10 units per plastic tube
- Marking: BYT230PIV-1000M

BYT230PIV-1000M

**ULTRAFAST
RECTIFIERS
60 AMPS
1000 VOLTS**

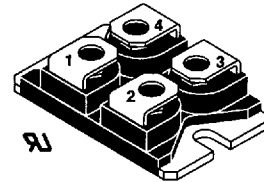
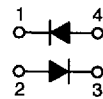

SOT-227B

MAXIMUM RATINGS

Rating	Symbol	Max	Unit
Peak Repetitive Reverse Voltage	V _{RRM}	1000	V
Average Rectified Current T _C = 55°C	I _{F(AV)}	60 30	A
Peak Repetitive Forward Current, Per Diode t _p < 10 μs	I _{FRM}	375	A
Nonrepetitive Peak Surge Current (Surge applied at rated load conditions halfwave, single phase, 60 Hz)	I _{FSM}	200	A
Operating Junction Temperature	T _J	-40 to +150	°C
Storage Temperature	T _{stg}	-40 to +150	°C

THERMAL CHARACTERISTICS

Thermal Resistance, Junction to Case	Per Diode	R _{θJC}	1.5	°C/W
Coupling	Per Device	R _{θJC}	0.8	
		R _{θC}	0.1	

ELECTRICAL CHARACTERISTICS PER DIODE

Instantaneous Forward Voltage (1) I _F = 30 A, T _C = 25°C I _F = 30 A, T _C = 100°C	V _F	1.9 1.8	V
Instantaneous Reverse Current (2) V _R = 1000 V, T _C = 25°C V _R = 1000 V, T _C = 100°C	I _R	100 5	μA mA

- (1) Pulse Test: Pulse Width = 380 μs, Duty Cycle ≤ 2%
(2) Pulse Test: Pulse Width = 5 ms, Duty Cycle < 2%



BYT230PIV-1000M**RECOVERY CHARACTERISTICS**

Test Conditions	Symbol	Typ	Max	Unit
$I_F = 1\text{ A}$, $V_R = 30\text{ V}$, $dI_F/dt = -15\text{ A}/\mu\text{s}$ $I_F = 0.5\text{ A}$, $I_R = 1\text{ A}$, $I_{rr} = 0.25\text{ A}$	t_{rr}	— —	165 70	ns

TURN-OFF SWITCHING CHARACTERISTICS (without series inductance)

Test Conditions	Symbol	Typ	Max	Unit
$V_{CC} = 200\text{ V}$, $I_F = 30\text{ A}$, $T_J = 100^\circ\text{C}$, $L_p < 0.05\ \mu\text{H}$ (See Figure 11) $dI_F/dt = -120\text{ A}/\mu\text{s}$ $dI_F/dt = -240\text{ A}/\mu\text{s}$	t_{IRM}	— 120	200 —	ns
$dI_F/dt = -120\text{ A}/\mu\text{s}$ $dI_F/dt = -240\text{ A}/\mu\text{s}$	I_{RM}	— 22	19.5 —	A

TURN-OFF OVERVOLTAGE COEFFICIENT (with series inductance)

Test Conditions	Symbol	Typ	Max	Unit
$T_J = 100^\circ\text{C}$, $V_{CC} = 200\text{ V}$, $I_F = I_{F(AV)}$ $dI_F/dt = -30\text{ A}/\mu\text{s}$, $L_p = 5\ \mu\text{H}$ (See Figure 12)	$C = \frac{V_{RP}}{V_{CC}}$	—	4.5	

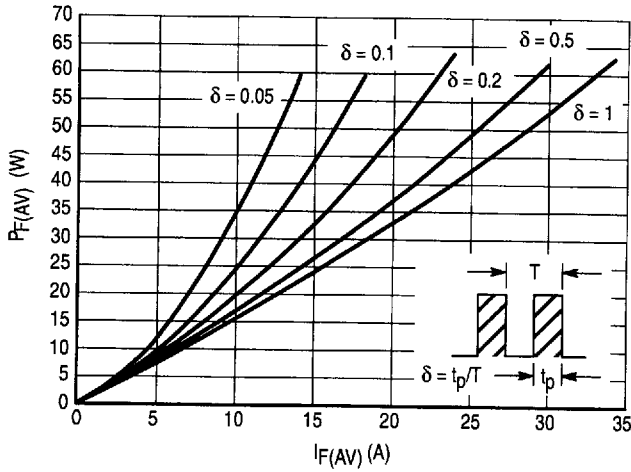

Figure 1. Low Frequency Power Losses versus Average Current

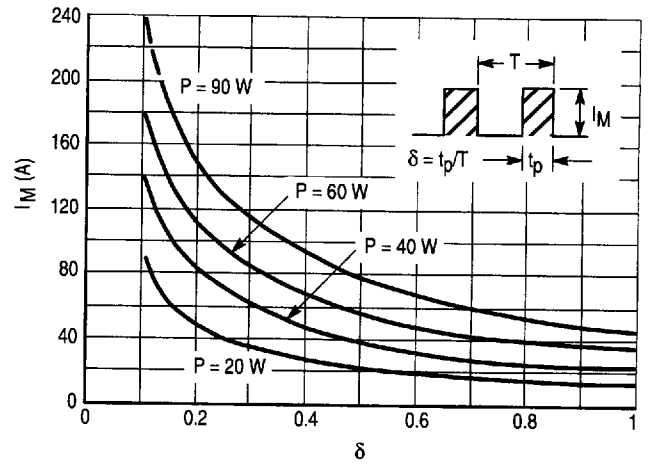

Figure 2. Peak Current versus Form Factor

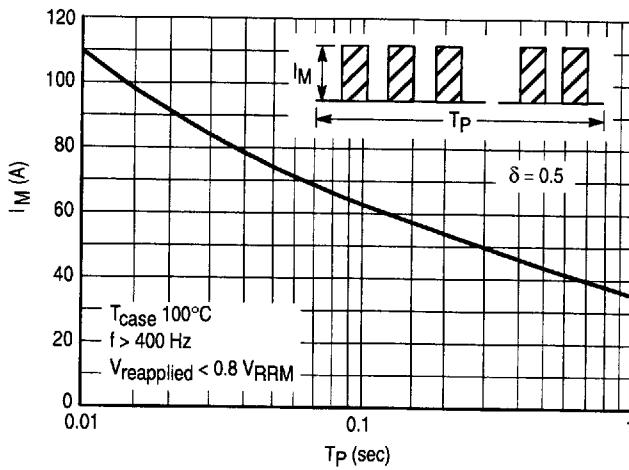

Figure 3. Non-Repetitive Peak Surge Current versus Overload Duration

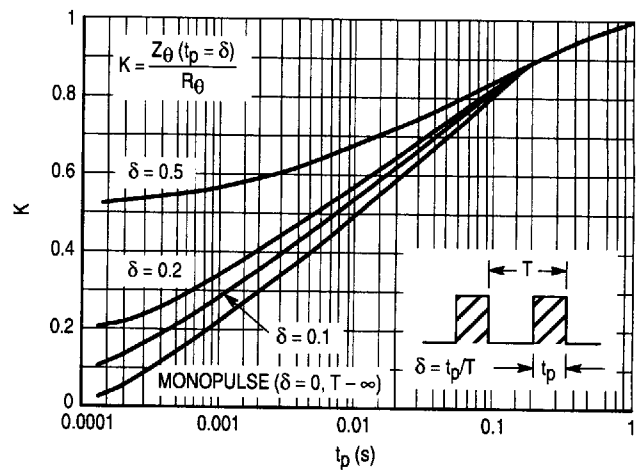

Figure 4. Relative Variation of Thermal Impedance Junction to Case versus Pulse Duration

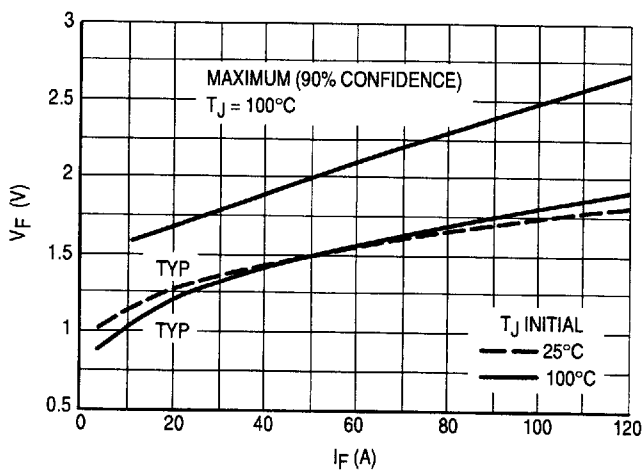

Figure 5. Voltage Drop versus Forward Current

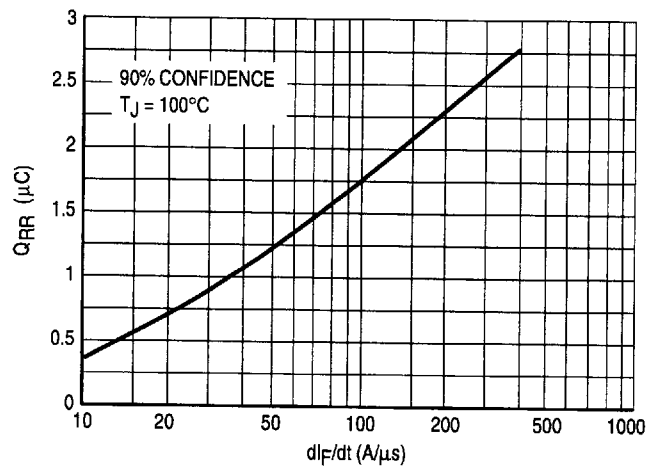

Figure 6. Recovery Charge versus di_F/dt

BYT230PIV-1000M

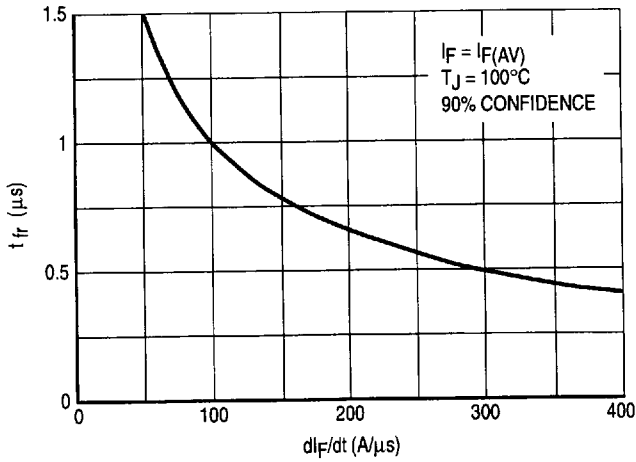

Figure 7. Recovery Time versus di_F/dt

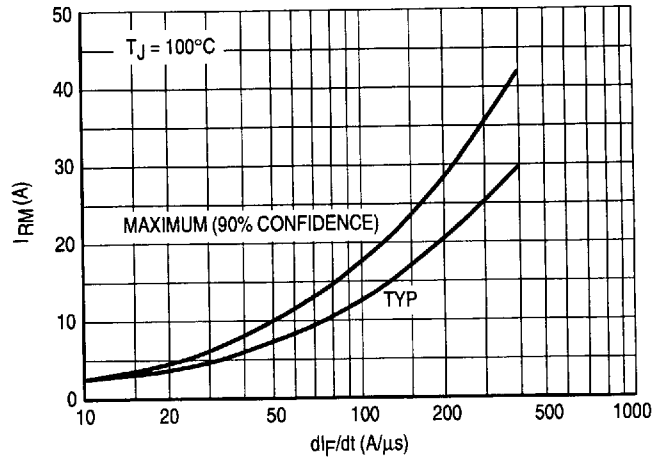

Figure 8. Peak Reverse Current versus di_F/dt

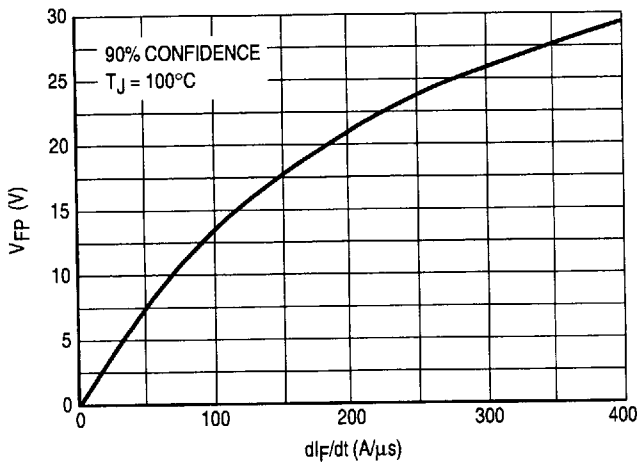

Figure 9. Peak Forward Voltage versus di_F/dt

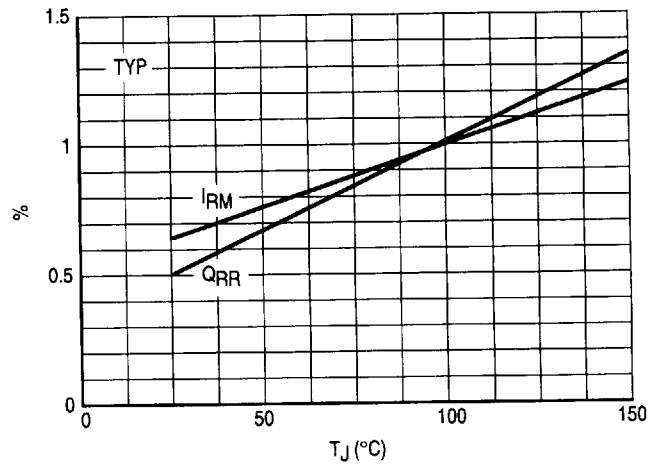

Figure 10. Dynamic Parameters versus Junction Temperature

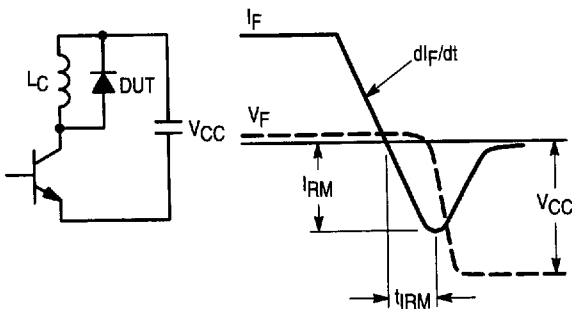

Figure 11. Turn-Off Switching Characteristics (Without series inductance)

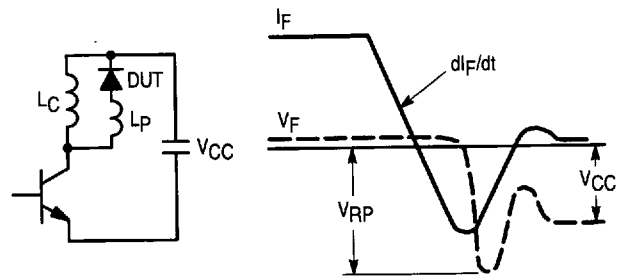
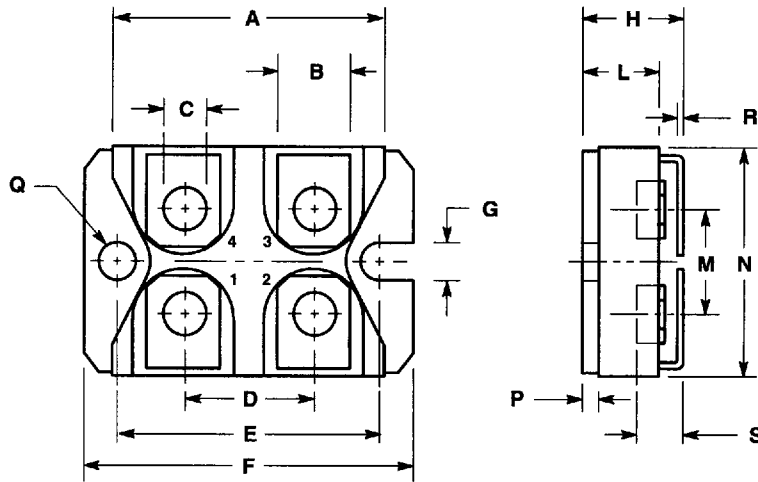

Figure 12. Turn-Off Switching Characteristics (With series inductance)

PACKAGE DIMENSIONS



- NOTES:
 1. DIMENSIONING AND TOLERANCING PER ANSI Y14.5M, 1982.
 2. CONTROLLING DIMENSION: MILLIMETERS.

DIM	MILLIMETERS		INCHES	
	MIN	MAX	MIN	MAX
A	31.50	31.70	1.240	1.248
B	7.80	8.20	0.307	0.322
C	4.10	4.30	0.161	0.169
D	14.90	15.10	0.586	0.590
E	30.10	30.30	1.185	1.193
F	38.00	38.20	1.496	1.503
G	4.00	—	0.157	—
H	11.80	12.20	0.464	0.480
L	8.90	9.10	0.350	0.358
M	12.60	12.80	0.496	0.503
N	25.20	25.40	0.992	1.000
P	1.95	2.05	0.076	0.080
Q	4.10	—	0.157	—
R	0.75	0.85	0.030	0.033
S	5.50	—	0.217	—

Recommended screw torque: 1.3 ± 0.2 Nm
 Maximum screw torque: 1.5 Nm

SOT-227B