



BYT230PIV-400 BYT231PIV-400

FAST RECOVERY RECTIFIER DIODES

MAIN PRODUCT CHARACTERISTICS

$I_{F(AV)}$	2 x 30 A
V_{RRM}	400 V
$V_F(max)$	1.4 V
$t_{rr}(max)$	50 ns

FEATURES AND BENEFITS

- VERY LOW REVERSE RECOVERY TIME
- VERY LOW SWITCHING LOSSES
- LOW NOISE TURN-OFF SWITCHING
- INSULATED PACKAGE: ISOTOP
Insulation voltage: 2500 V_{RMS}
Capacitance = 45 pF
Inductance < 5 nH

DESCRIPTION

These rectifier devices are suited for free-wheeling function in converters and motor control circuits.

Packaged in ISOTOP, they are intended for use in Switch Mode Power Supplies.

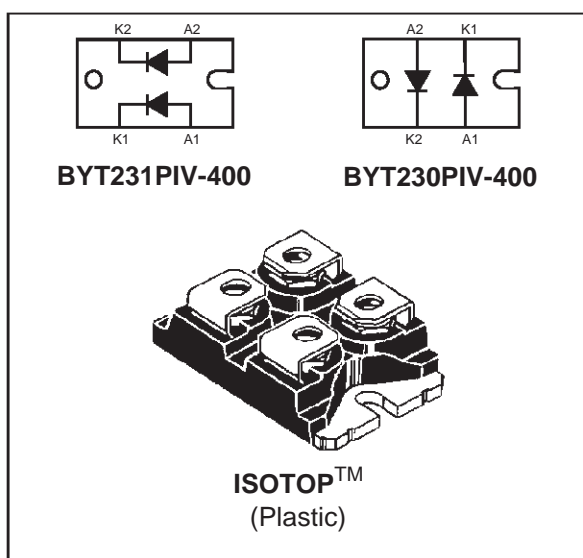

ABSOLUTE RATINGS (limiting values, per diode)

Symbol	Parameter		Value	Unit
V_{RRM}	Repetitive peak reverse voltage		400	V
I_{FRM}	Repetitive peak forward current	$t_p=5 \mu s$ $F=1kHz$	900	A
$I_{F(RMS)}$	RMS forward current		50	A
$I_{F(AV)}$	Average forward current	$T_c = 75^\circ C$ $\delta = 0.5$	30	A
I_{FSM}	Surge non repetitive forward current	$t_p = 10 ms$ Sinusoidal	350	A
T_{stg}	Storage temperature range		- 40 to + 150	$^\circ C$
T_j	Maximum operating junction temperature		150	$^\circ C$

TM: ISOTOP is a registered trademark of STMicroelectronics.

BYT230PIV-400 / BYT231PIV-400

THERMAL RESISTANCES

Symbol	Parameter		Value	Unit
$R_{th(j-c)}$	Junction to case	Per diode	1.5	°C/W
		Total	0.8	
$R_{th(c)}$		Coupling	0.1	

When the diodes 1 and 2 are used simultaneously :

$$\Delta T_{j(\text{diode } 1)} = P(\text{diode } 1) \times R_{th(j-c)} (\text{Per diode}) + P(\text{diode } 2) \times R_{th(c)}$$

STATIC ELECTRICAL CHARACTERISTICS (per diode)

Symbol	Parameter	Test Conditions		Min.	Typ.	Max.	Unit
V_F^*	Forward voltage drop	$T_j = 25^\circ\text{C}$	$I_F = 30\text{ A}$			1.5	V
		$T_j = 100^\circ\text{C}$				1.4	
I_R^{**}	Reverse leakage current	$T_j = 25^\circ\text{C}$	$V_R = V_{RRM}$			35	μA
		$T_j = 100^\circ\text{C}$				6	mA

Pulse test : * $t_p = 380\ \mu\text{s}$, $\delta < 2\%$

** $t_p = 5\ \text{ms}$, $\delta < 2\%$

To evaluate the conduction losses use the following equation:

$$P = 1.1 \times I_{F(AV)} + 0.0095 I_F^2(\text{RMS})$$

RECOVERY CHARACTERISTICS

Symbol	Test Conditions		Min.	Typ.	Max.	Unit
t_{rr}	$T_j = 25^\circ\text{C}$	$I_F = 1\text{ A}$ $V_R = 30\text{ V}$ $di_F/dt = -15\text{ A}/\mu\text{s}$			100	ns
		$I_F = 0.5\text{ A}$ $I_R = 1\text{ A}$ $I_{rr} = 0.25\text{ A}$			50	

TURN-OFF SWITCHING CHARACTERISTICS

Symbol	Parameter	Test Conditions		Min.	Typ.	Max.	Unit
t_{IRM}	Maximum reverse recovery time	$di_F/dt = -120\text{ A}/\mu\text{s}$	$V_{CC} = 200\text{ V}$ $I_F = 30\text{ A}$ $L_p \text{ @ } 0.05\ \mu\text{H}$ $T_j = 100^\circ\text{C}$ (see fig. 13)			75	ns
		$di_F/dt = -240\text{ A}/\mu\text{s}$				50	
I_{RM}	Maximum reverse recovery current	$di_F/dt = -120\text{ A}/\mu\text{s}$	$V_{CC} = 200\text{ V}$ $I_F = 30\text{ A}$ $L_p \text{ @ } 0.05\ \mu\text{H}$ $T_j = 100^\circ\text{C}$ (see fig. 13)			9	A
		$di_F/dt = -240\text{ A}/\mu\text{s}$				12	
$C = \frac{V_{RP}}{V_{CC}}$	Turn-off overvoltage coefficient	$T_j = 100^\circ\text{C}$ $V_{CC} = 60\text{ V}$ $I_F = I_{F(AV)}$ $di_F/dt = -30\text{ A}/\mu\text{s}$ $L_p = 1\ \mu\text{H}$ (see fig. 14)			3.3		/

Fig. 1: Average forward power dissipation versus average forward current (per diode).

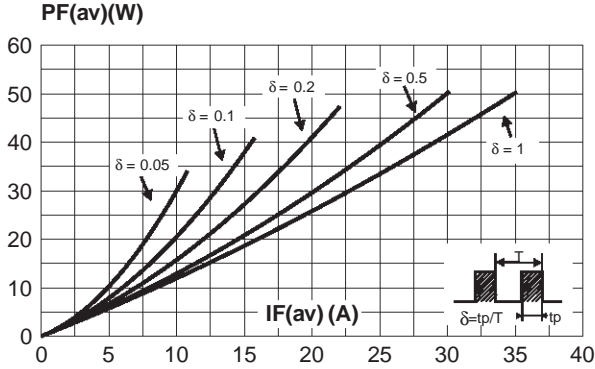

Fig. 2: Peak current versus form factor (per diode).

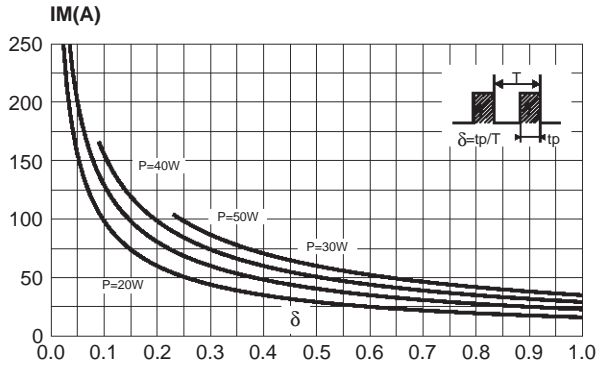

Fig. 3: Average forward current versus ambient temperature ($\delta=0.5$, per diode).

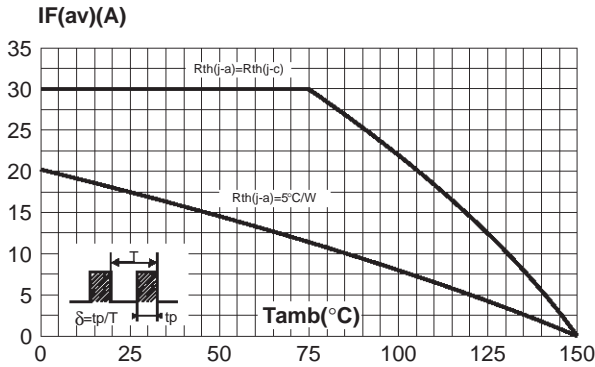

Fig. 4: Non repetitive surge peak forward current versus overload duration (per diode).

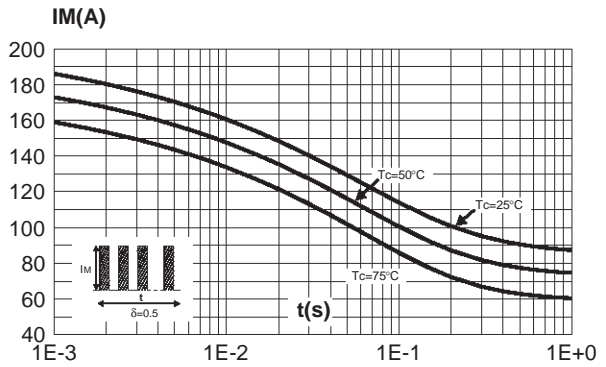

Fig. 5: Relative variation of thermal impedance junction to case versus pulse duration (per diode).

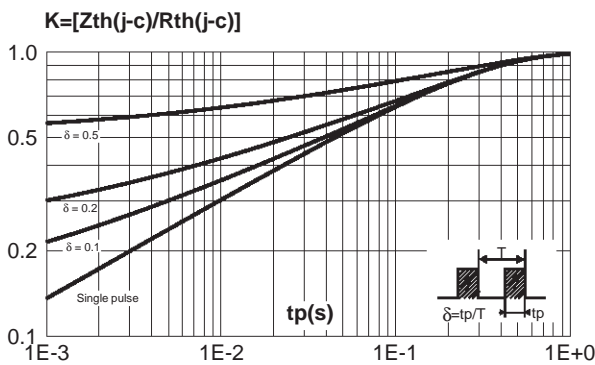

Fig. 6: Forward voltage drop versus forward current (maximum values, per diode).

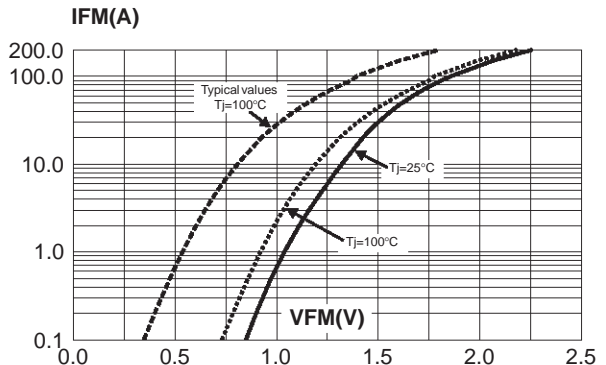

Fig. 7: Junction capacitance versus reverse voltage applied (typical values, per diode).

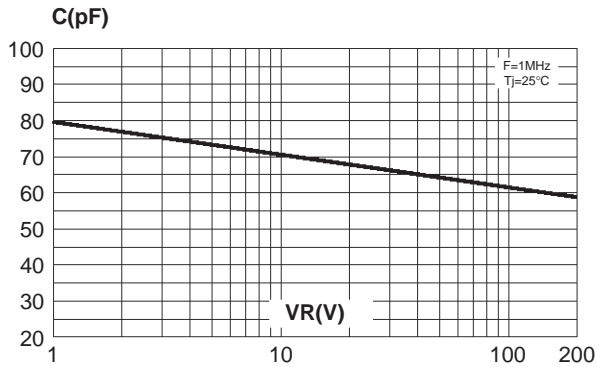

Fig. 8: Recovery charges versus di_F/dt (per diode).

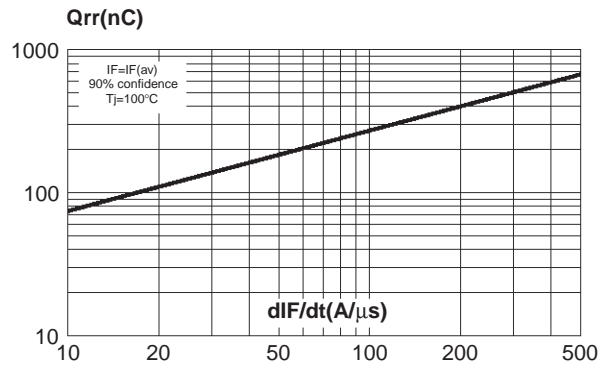

Fig. 9: Recovery current versus di_F/dt (per diode).

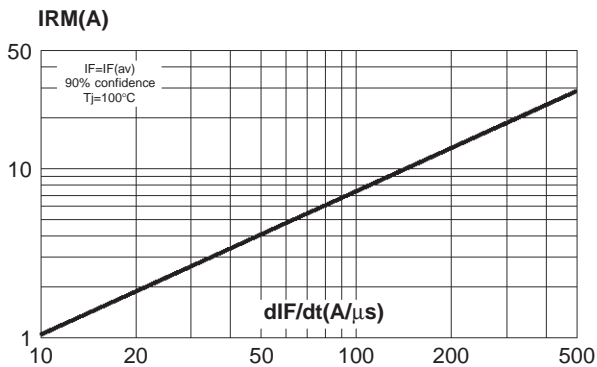

Fig. 10: Transient peak forward voltage versus di_F/dt (per diode).

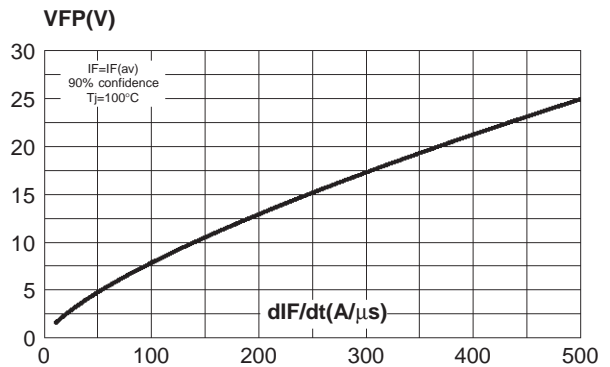

Fig. 11: Forward recovery time versus di_F/dt (per diode).

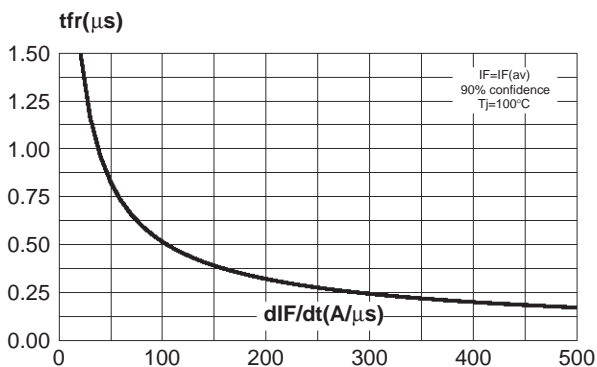

Fig. 12: Dynamic parameters versus junction temperature.

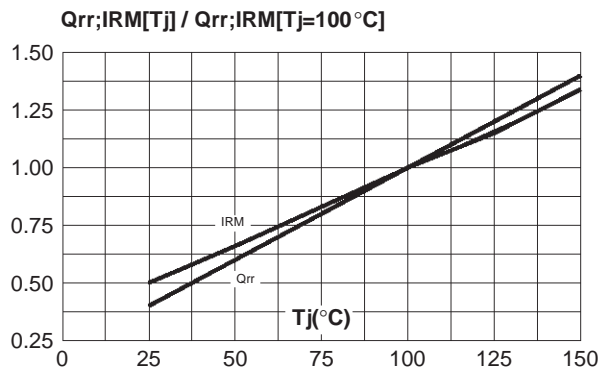

Fig. 13: Turn-off switching characteristics (without serie inductance).

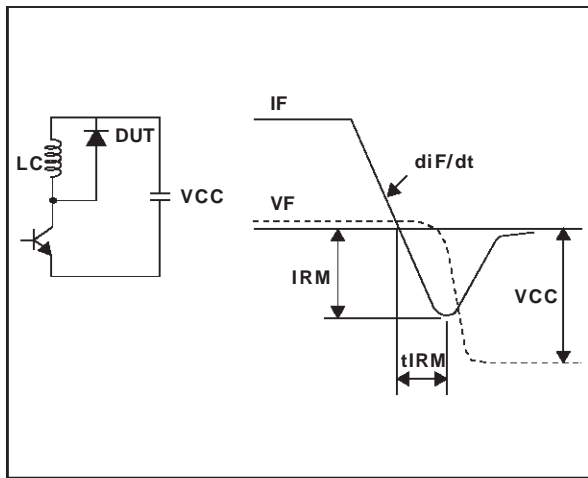
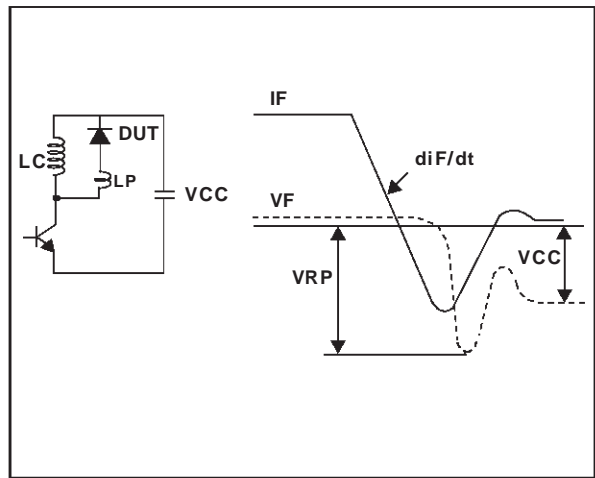
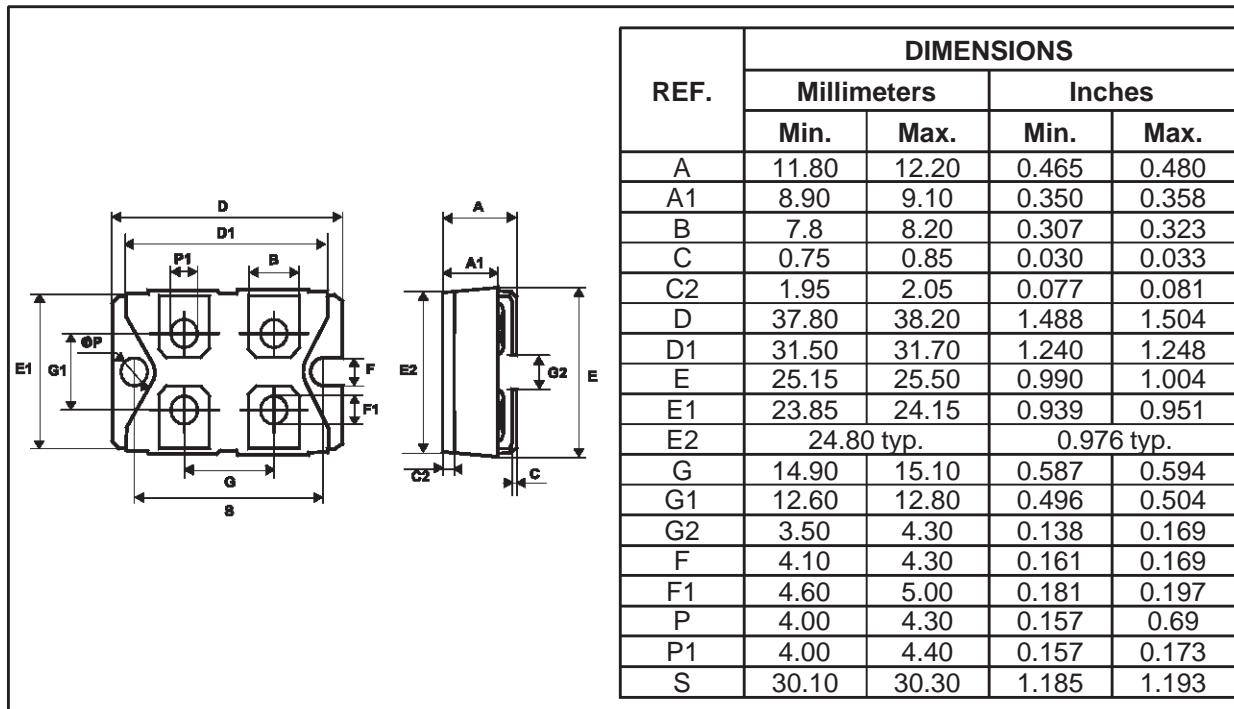

Fig. 14: Turn-off switching characteristics (with serie inductance).



BYT230PIV-400 / BYT231PIV-400

PACKAGE MECHANICAL DATA
ISOTOP



Ordering type	Marking	Package	Weight	Base qty	Delivery mode
BYT230PIV-400	BYT230PIV-400	ISOTOP	28 g. (without screws)	10	Tube
BYT231PIV-400	BYT231PIV-400	ISOTOP	28 g. (without screws)	10	Tube

- Cooling method: by conduction (C)
- Recommended torque value : 1.3 N.m (MAX 1.5 N.m) for the 6 x M4 screws. (2 x M4 screws recommended for mounting the package on the heatsink and the 4 screws given with the screw version). The screws supplied with the package are adapted for mounting on a board (or other types of terminals) with a thickness of 0.6 mm min and 2.2 mm max.
- Epoxy meets UL94,V0

Information furnished is believed to be accurate and reliable. However, STMicroelectronics assumes no responsibility for the consequences of use of such information nor for any infringement of patents or other rights of third parties which may result from its use. No license is granted by implication or otherwise under any patent or patent rights of STMicroelectronics. Specifications mentioned in this publication are subject to change without notice. This publication supersedes and replaces all information previously supplied. STMicroelectronics products are not authorized for use as critical components in life support devices or systems without express written approval of STMicroelectronics.

The ST logo is a registered trademark of STMicroelectronics

© 2000 STMicroelectronics - Printed in Italy - All rights reserved.

STMicroelectronics GROUP OF COMPANIES

Australia - Brazil - China - Finland - France - Germany - Hong Kong - India - Italy - Japan - Malaysia
Malta - Morocco - Singapore - Spain - Sweden - Switzerland - United Kingdom - U.S.A.

<http://www.st.com>

