

## HIGH EFFICIENCY FAST RECOVERY DIODES

### MAIN PRODUCT CHARACTERISTICS

$I_{F(AV)}$	8 A
$V_{RRM}$	200 V
$t_{rr} (max)$	25 ns
$V_F (max)$	0.85 V

### FEATURES AND BENEFITS

- Very Low Forward Losses
- Negligible switching losses
- High surge current capability
- Insulated packages (ISOWATT220AC, TO-220FPAC):  
Insulation voltage: 2000 VDC  
Typical insulation capacitance = 12 pF

### DESCRIPTION

Single rectifier suited for Switch Mode Power Supply and high frequency DC to DC converters. Packaged in TO-220AC, ISOWATT220AC, TO-220FPAC and D<sup>2</sup>PAK, this device is intended for use in high frequency inverters, free wheeling and polarity protection applications.

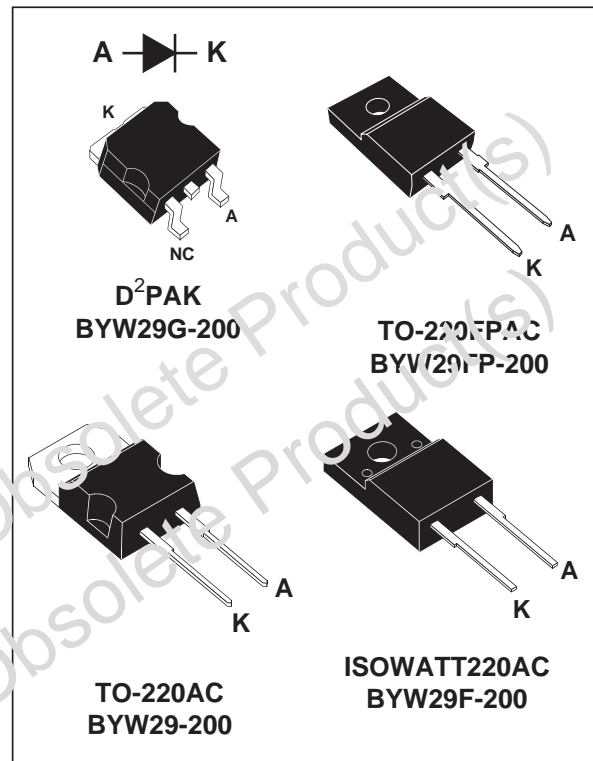

### ABSOLUTE MAXIMUM RATINGS

Symbol	Parameter		Value	Unit	
$V_{RRM}$	Repetitive peak reverse voltage		200	V	
$I_{F(RMS)}$	RMS forward current		16	A	
$I_{F(AV)}$	Average forward current $\delta = 0.5$	D <sup>2</sup> PAK / TO-220AC	$T_c = 120^\circ\text{C}$	8	A
		ISOWATT220AC / TO-220FPAC	$T_c = 100^\circ\text{C}$		
$I_{FSM}$	Surge non repetitive forward current (All pins connected)		$t_p = 10\text{ms}$ sinusoidal	80	A
$T_{stg}$	Storage and junction temperature range		- 65 to + 150	°C	
$T_j$	Maximum operating junction temperature		+ 150		

**BYW29/F/FP/G-200****THERMAL RESISTANCE**

Symbol	Parameter		Value	Unit
Rth (j-c)	Junction to case thermal resistance	TO-220AC D2PAK	2.8	°C/W
		ISOWATT220AC	5	
		TO-220FPAC	5.5	

**STATIC ELECTRICAL CHARACTERISTICS**

Symbol	Parameter	Test Conditions		Min.	Typ.	Max.	Unit
I <sub>R</sub> *	Reverse leakage current	V <sub>R</sub> = V <sub>RRM</sub>	T <sub>j</sub> = 25°C			10	μA
			T <sub>j</sub> = 100°C			0.6	mA
V <sub>F</sub> **	Forward voltage drop	I <sub>F</sub> = 5 A	T <sub>j</sub> = 125°C			0.85	V
		I <sub>F</sub> = 10 A	T <sub>j</sub> = 125°C			1.05	
		I <sub>F</sub> = 10 A	T <sub>j</sub> = 25°C			1.15	

Pulse test : \* tp = 5 ms, duty cycle < 2 %

\*\* tp = 380 μs, duty cycle < 2 %

To evaluate the conduction losses use the following equation :

$$P = 0.65 \times I_{F(AV)} + 0.040 I_{F(RMS)}^2$$

**RECOVERY CHARACTERISTICS**

Symbol	Parameter	Test Conditions		Min.	Typ.	Max.	Unit
t <sub>rr</sub>	Reverse recovery time	T <sub>j</sub> = 25°C	I <sub>F</sub> = 0.5A			25	ns
		I <sub>rr</sub> = 0.25 A	I <sub>R</sub> = 1A				
t <sub>fr</sub>	Forward recovery time	T <sub>j</sub> = 25°C	I <sub>F</sub> = 1A			15	ns
		dI <sub>F</sub> /dt = -50A/μs	V <sub>R</sub> = 30V				
V <sub>FP</sub>	Peak forward voltage	T <sub>j</sub> = 25°C	I <sub>F</sub> = 1A			2	V
			dI <sub>F</sub> /dt = 100A/μs				

**Fig.1** : Average forward power dissipation versus average forward current.

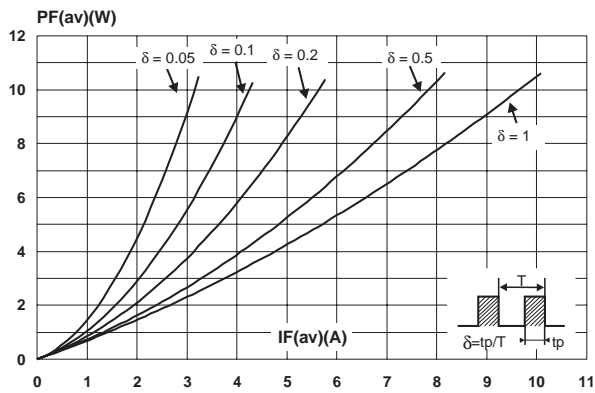

**Fig.2** : Peak current versus form factor.

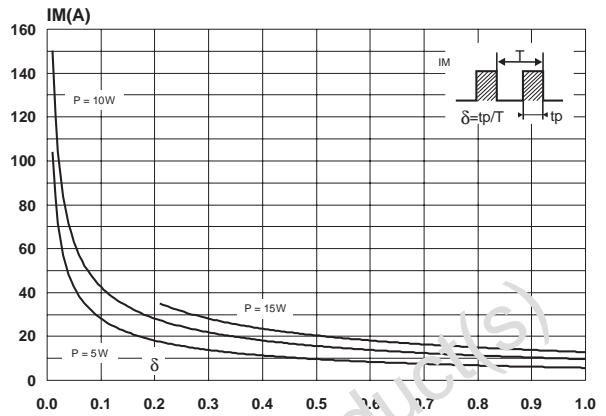

**Fig.3** : Forward voltage drop versus forward current (maximum values).

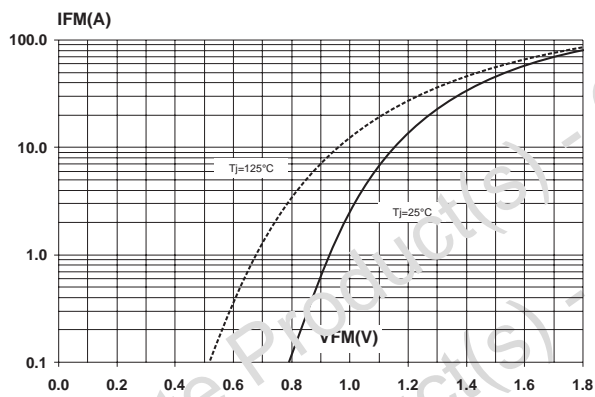

**Fig.4-1** : Relative variation of thermal impedance junction to case versus pulse duration (TO-220AC, D<sup>2</sup>PAK)

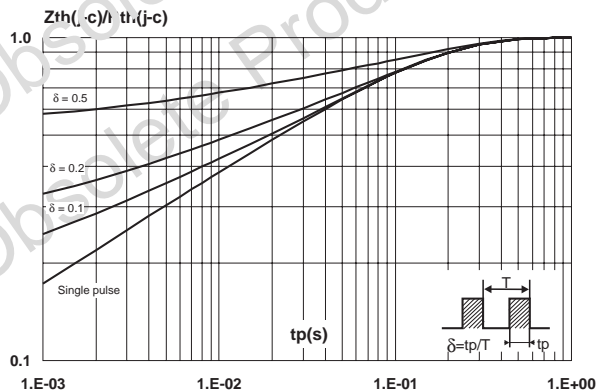

**Fig.4-2** : Relative variation of thermal impedance junction to case versus pulse duration (TO-220FPAC, ISOWATT220AC).

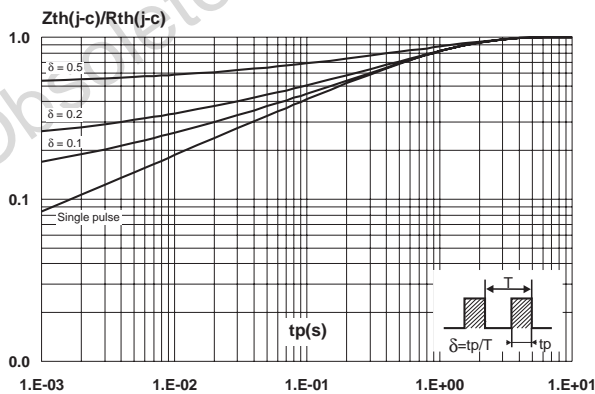

**Fig.5-1** : Non repetitive surge peak forward current versus overload duration (TO-220AC, D<sup>2</sup>PAK).

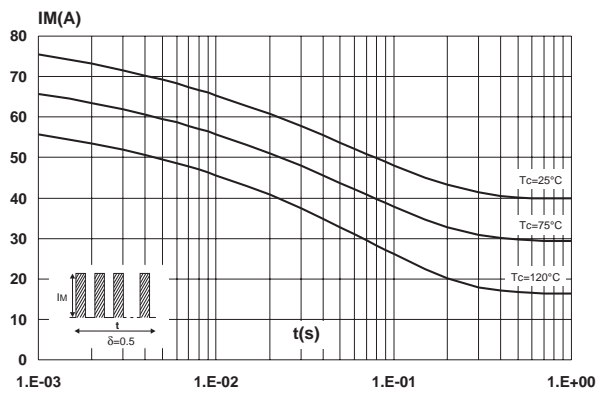

**Fig.5-2 :** Non repetitive surge peak forward current versus overload duration (TO-220FPAC, ISOWATT220AC).

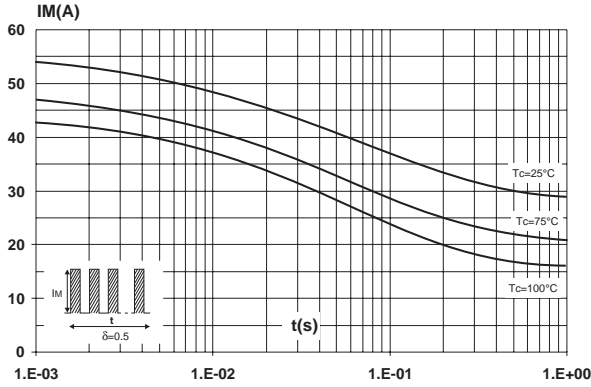

**Fig.6 :** Average current versus ambient temperature. ( $\delta = 0.5$ )

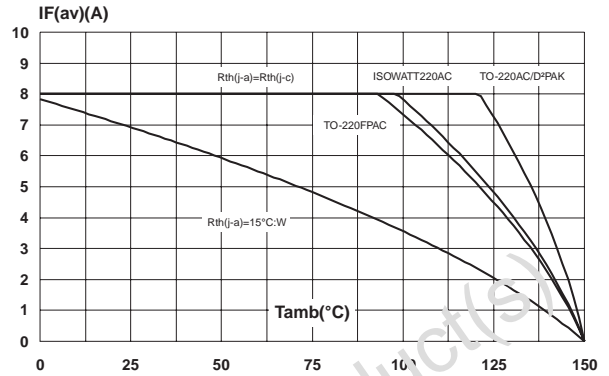

**Fig.7 :** Junction capacitance versus reverse voltage applied (Typical values).

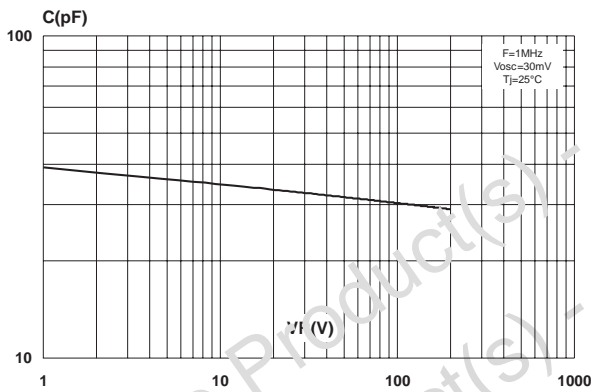

**Fig.8 :** Reverse recovery charges versus  $di/dt$  (90% confidence).

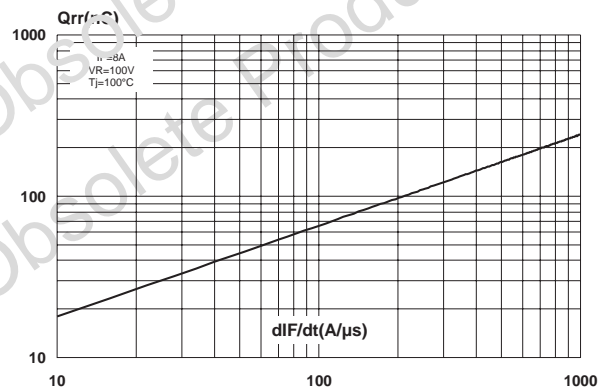

**Fig.9 :** Peak reverse recovery current versus  $di/dt$  (90% confidence).

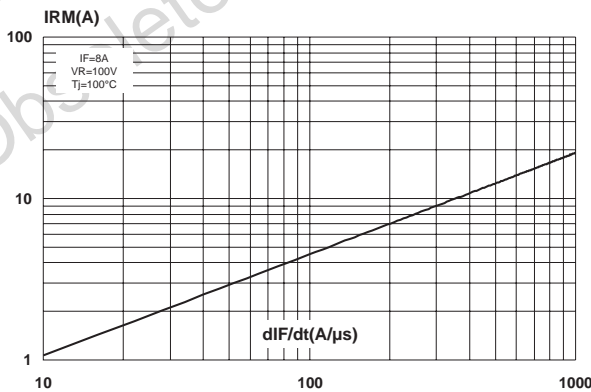

**Fig.10 :** Dynamic parameters versus junction temperature.

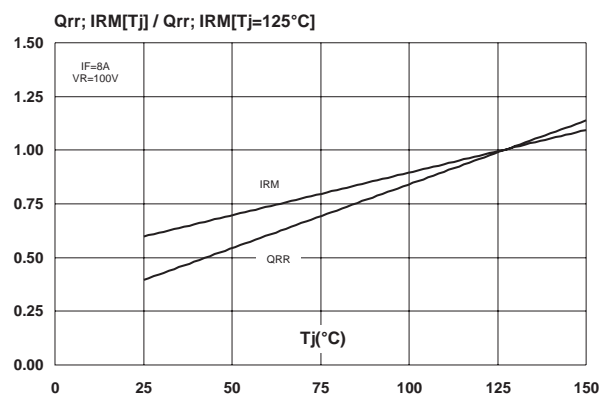

**Fig.11** : Thermal resistance junction to ambient versus copper surface under tab (Epoxy printed circuit board FR4, copper thickness: 35µm) for D<sup>2</sup>PAK.

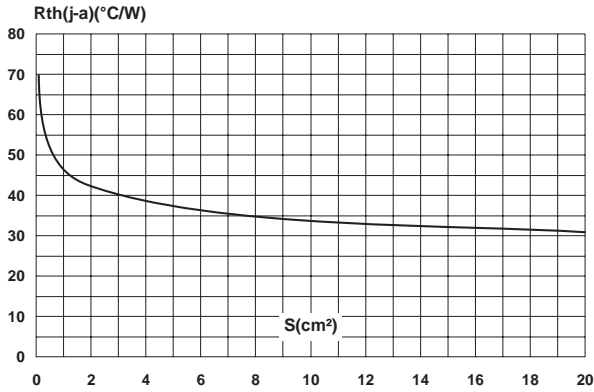

**PACKAGE MECHANICAL DATA**  
D<sup>2</sup>PAK (Plastic)

REF.	DIMENSIONS			
	Millimeters		Inches	
	Min.	Max.	Min.	Max.
A	4.40	4.60	0.173	0.181
A1	2.49	2.69	0.098	0.106
A2	0.03	0.23	0.001	0.009
B	0.70	0.93	0.027	0.037
B2	1.14	1.70	0.045	0.067
C	0.45	0.60	0.017	0.024
C2	1.23	1.36	0.048	0.054
D	8.95	9.35	0.352	0.368
E	10.00	10.40	0.393	0.409
G	4.88	5.28	0.192	0.208
L	15.00	15.85	0.590	0.624
L2	1.27	1.40	0.050	0.055
L3	1.40	1.75	0.055	0.069
M	2.40	3.20	0.094	0.126
R	0.40 typ.		0.016 typ.	
V2	0°	8°	0°	8°

\* FLAT ZONE NO LESS THAN 2mm

**FOOT PRINT (in millimeters)**

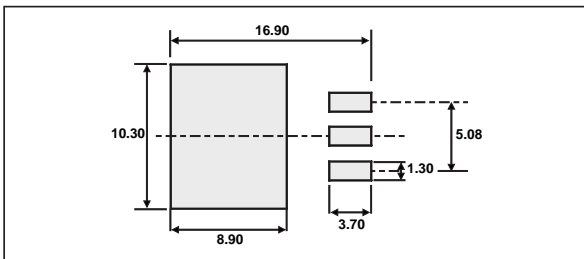

**BYW29/F/FP/G-200**

**PACKAGE MECHANICAL DATA**  
TO-220AC

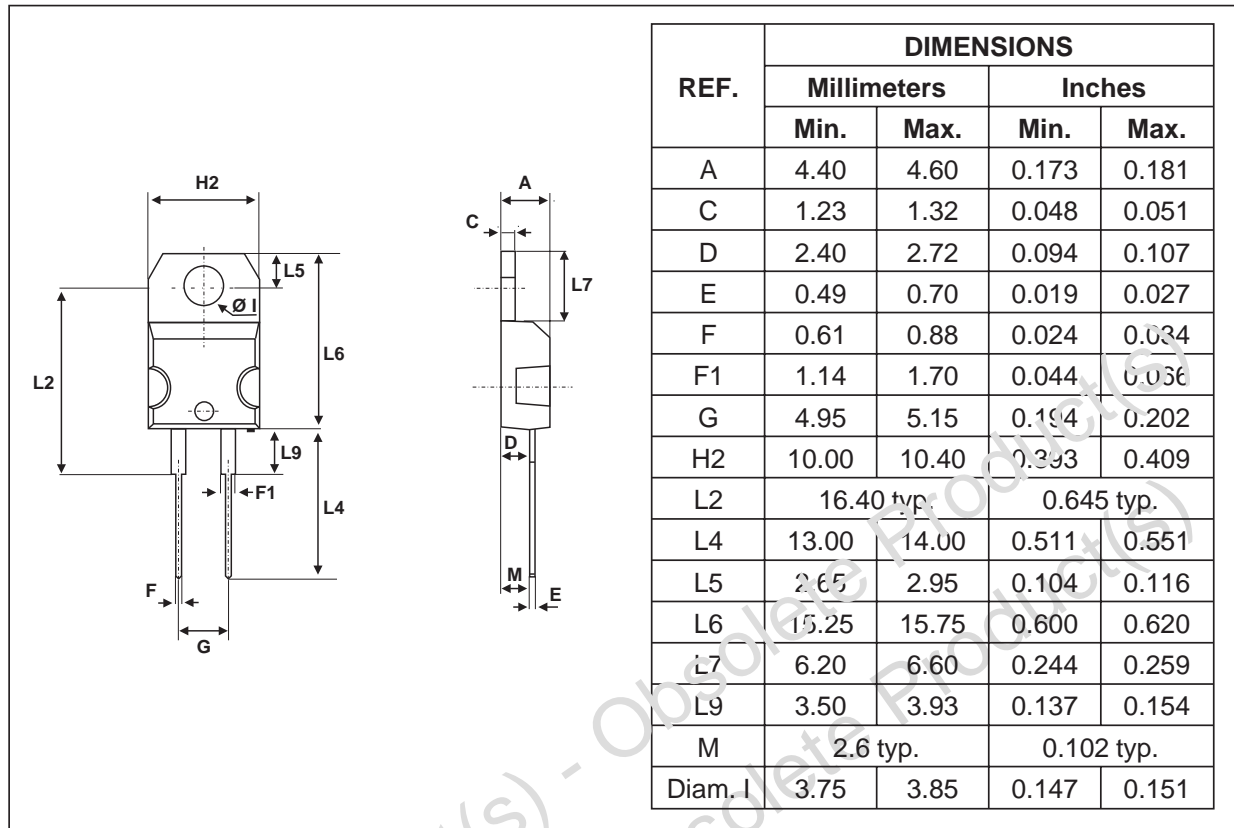

**PACKAGE MECHANICAL DATA**  
TO-220FPAC

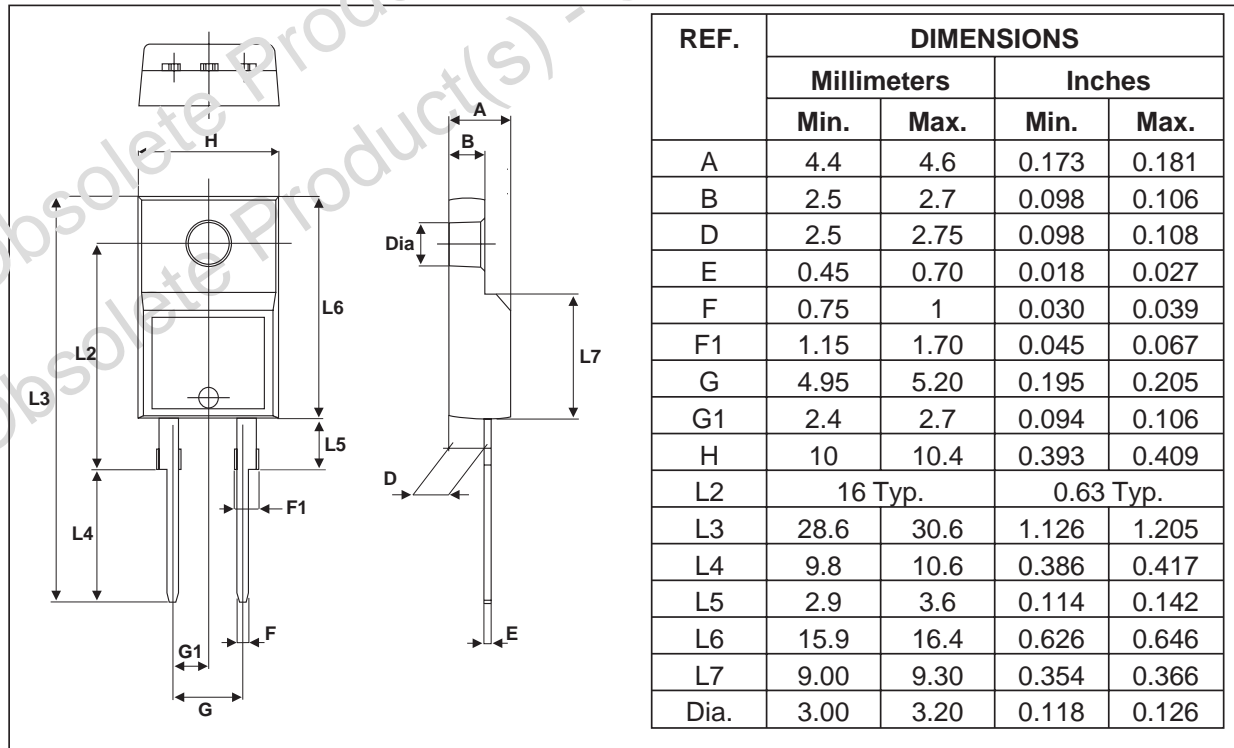

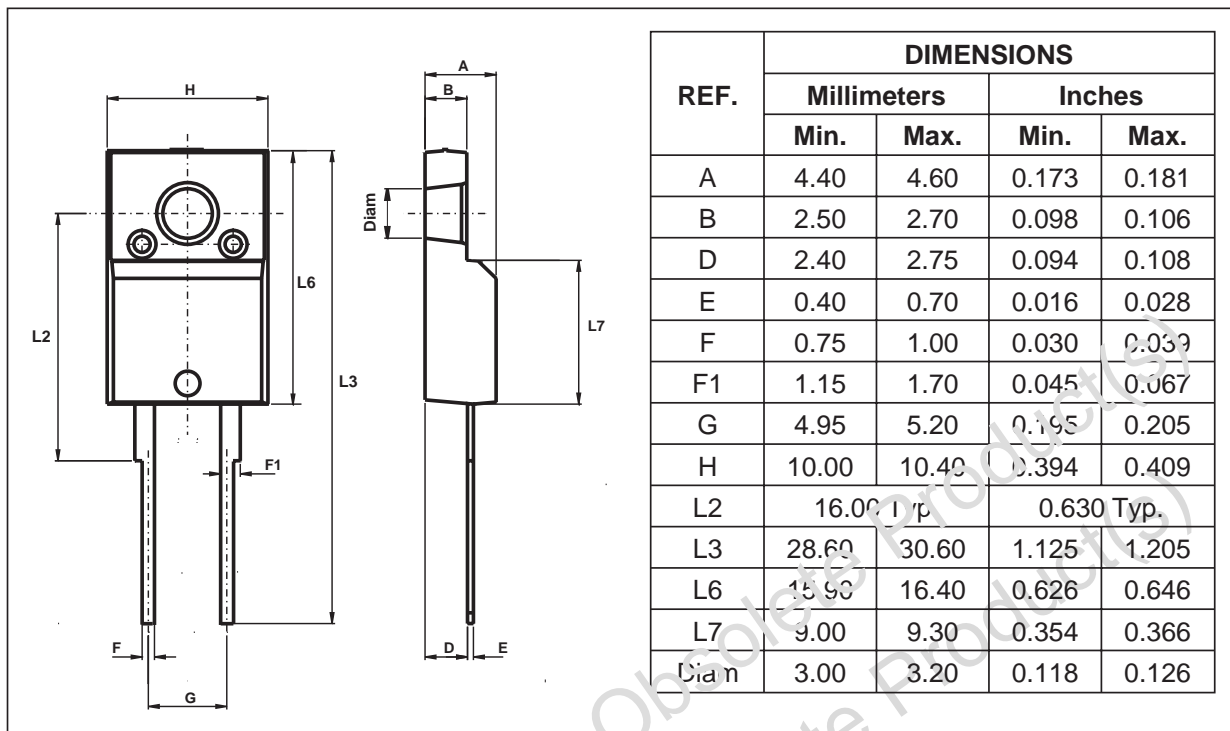
**PACKAGE MECHANICAL DATA**  
 ISOWATT220AC

Type	Marking	Package	Weight	Base Qty	Delivery Mode
BYW29-200	BYW29-200	TO-220AC	1.86 g	50	Tube
BYW29F-200	BYW29F-200	ISOWATT220AC	2.2 g	50	Tube
BYW29FP-200	BYW29FP-200	TO-220FPAC	2 g	50	Tube
BYW29G-200	BYW29G-200	D <sup>2</sup> PAK	1.48 g	50	Tube

- Cooling method: by conduction (C)
- Recommended torque value (ISOWATT220AC, TO-220FPAC): 0.55 N.m
- Maximum torque value: 0.7 N.m
- Recommended torque value (TO-220AC): 0.8 N.m
- Maximum torque value: 1.0 N.m
- Epoxy meets UL94, V0

Information furnished is believed to be accurate and reliable. However, STMicroelectronics assumes no responsibility for the consequences of use of such information nor for any infringement of patents or other rights of third parties which may result from its use. No license is granted by implication or otherwise under any patent or patent rights of STMicroelectronics. Specifications mentioned in this publication are subject to change without notice. This publication supersedes and replaces all information previously supplied.

STMicroelectronics products are not authorized for use as critical components in life support devices or systems without express written approval of STMicroelectronics.

The ST logo is a registered trademark of STMicroelectronics

© 2002 STMicroelectronics - Printed in Italy - All rights reserved.

STMicroelectronics GROUP OF COMPANIES

Australia - Brazil - Canada - China - Finland - France - Germany  
 Hong Kong - India - Israel - Italy - Japan - Malaysia - Malta - Morocco - Singapore  
 Spain - Sweden - Switzerland - United Kingdom - United States.

<http://www.st.com>