



BYW81G-200 BYW81P-200 / BYW81PI-200

HIGH EFFICIENCY FAST RECOVERY RECTIFIER DIODES

FEATURES

- SUITED FOR SMPS
- VERY LOW FORWARD LOSSES
- NEGLIGIBLE SWITCHING LOSSES
- HIGH SURGE CURRENT CAPABILITY
- HIGH AVALANCHE ENERGY CAPABILITY
- INSULATED VERSION :
Insulating voltage = 2500 V_{RMS}
Capacitance = 7 pF

DESCRIPTION

Single chip rectifier suited for switchmode power supply and high frequency DC to DC converters. Packaged in TO-220AC and D²PAK, this device is intended for use in low voltage, high frequency inverters, free wheeling and polarity protection applications.

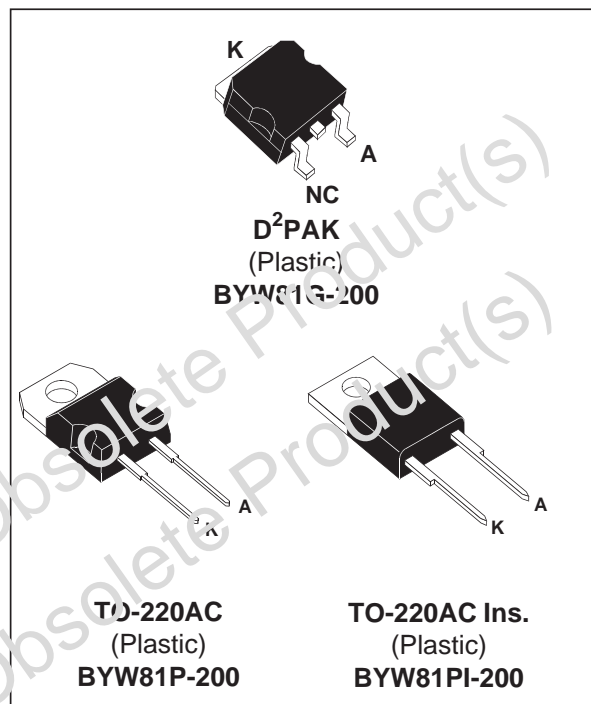

ABSOLUTE MAXIMUM RATINGS

Symbol	Parameter		Value	Unit	
I _{F(RMS)}	RMS forward current		35	A	
I _{F(AV)}	Average forward current δ = 0.5	BYW81P	T _c =115°C	15	A
		BYW81PI/G	T _c =90°C	15	
I _{FSM}	Surge non repetitive forward current	tp=10ms sinusoidal	200	A	
T _{stg} T _j	Storage and junction temperature range		- 40 to + 150 - 40 to + 150	°C °C	

Symbol	Parameter	Value	Unit
V _{RRM}	Repetitive peak reverse voltage	200	V

BYW81P-200 / BYW81PI-200 / BYW81G-200

THERMAL RESISTANCE

Symbol	Parameter		Value	Unit
Rth (j-c)	Junction to case	BYW81P	2.0	°C/W
		BYW81PI / G	3.5	

**ELECTRICAL CHARACTERISTICS
STATIC CHARACTERISTICS**

Symbol	Test Conditions		Min.	Typ.	Max.	Unit
I _R *	T _j = 25°C	V _R = V _{RRM}			20	μA
	T _j = 100°C				1.5	mA
V _F **	T _j = 125°C	I _F = 12 A			0.85	V
	T _j = 125°C	I _F = 25 A			1.05	
	T _j = 25°C	I _F = 25 A			1.15	

Pulse test :

* tp = 5 ms, duty cycle < 2 %

** tp = 380 μs, duty cycle < 2 %

RECOVERY CHARACTERISTICS

Symbol	Test Conditions			Min.	Typ.	Max.	Unit
trr	T _j = 25°C	I _F = 0.5A I _R = 1A	I _{rr} = 0.25A			25	ns
		I _F = 1A V _R = 30V	dI _F /dt = -50A/μs			40	
tfr	T _j = 25°C	I _F = 1A V _{FR} = 1.1 x V _F	tr = 10 ns		15		ns
V _{FP}	T _j = 25°C	I _F = 1A	tr = 10 ns		2		V

Fig. 1: Average forward power dissipation versus average forward current.

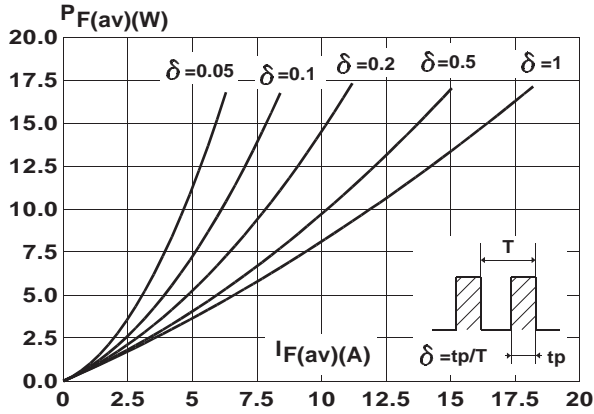

Fig. 2: Peak current versus form factor.

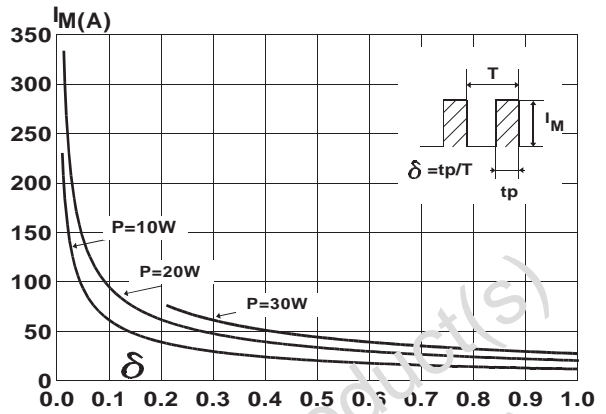

Fig. 3: Forward voltage drop versus forward current (maximum values).

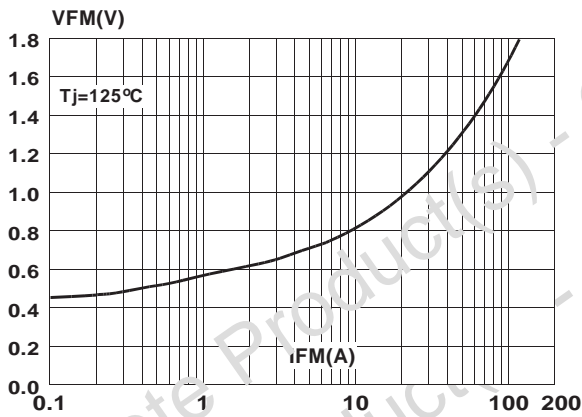

Fig. 4: Relative variation of thermal impedance junction to case versus pulse duration.

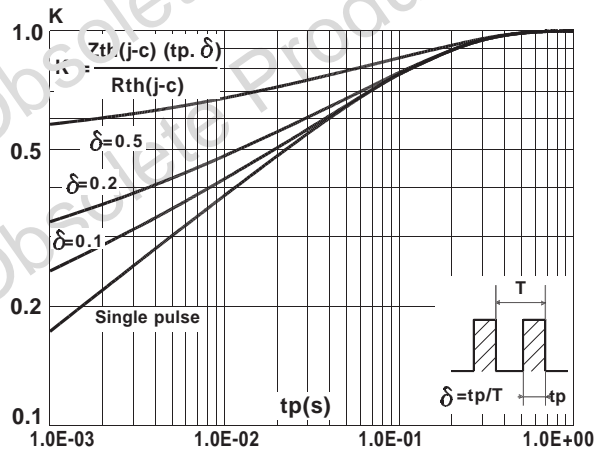

Fig. 5: Non repetitive surge peak forward current versus overload duration. (BYW81P)

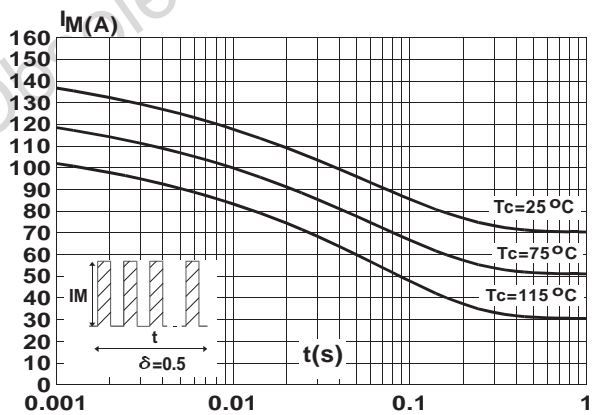

Fig. 6: Non repetitive surge peak forward current versus overload duration. (BYW81PI / BYW81G)

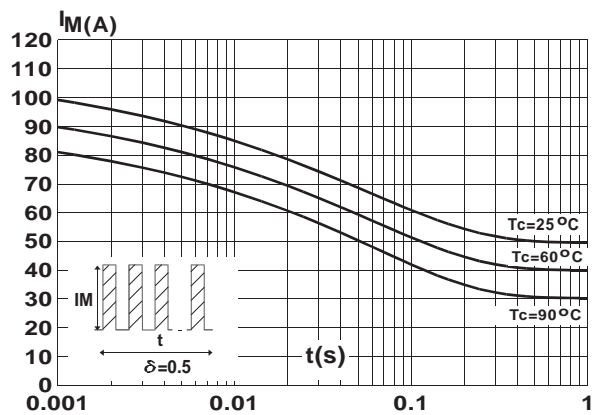

Fig. 7: Average current versus ambient temperature.
(duty cycle : 0.5) (BYW81P)

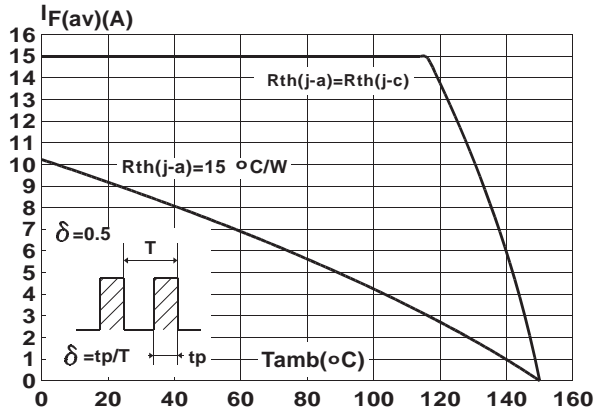

Fig. 8: Average current versus ambient temperature.
(duty cycle : 0.5) (BYW81PI / BYW81G)

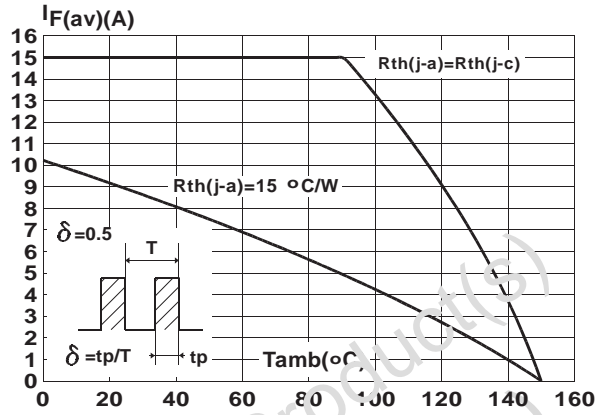

Fig. 9: Junction capacitance versus reverse voltage applied (Typical values).

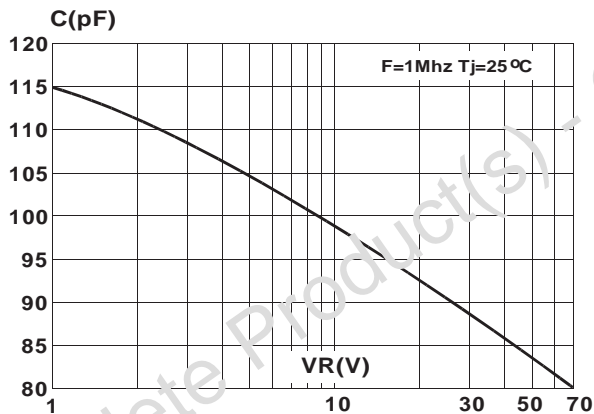

Fig. 10: Recovery charges versus dI_F/dt .

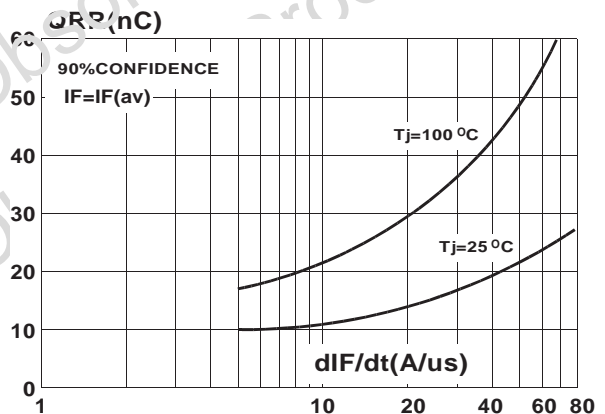

Fig. 11: Peak reverse current versus dI_F/dt .

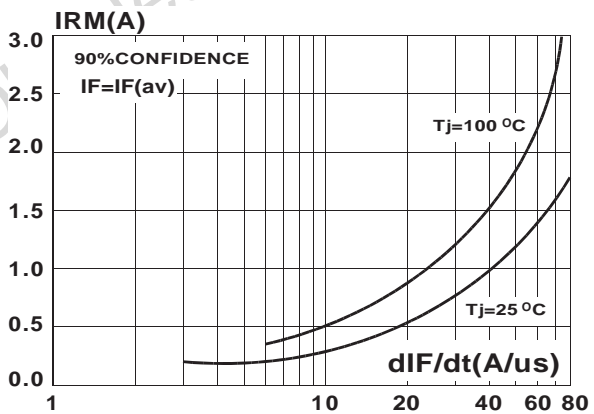
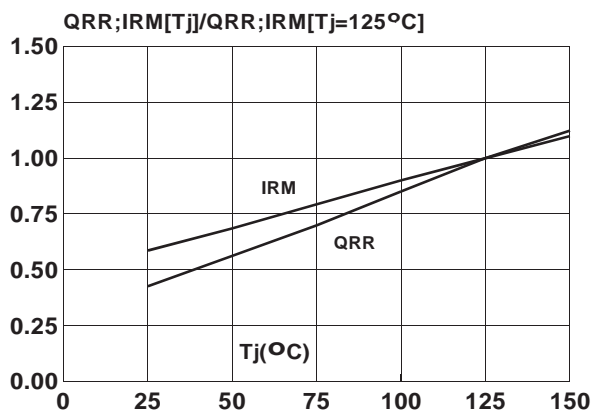
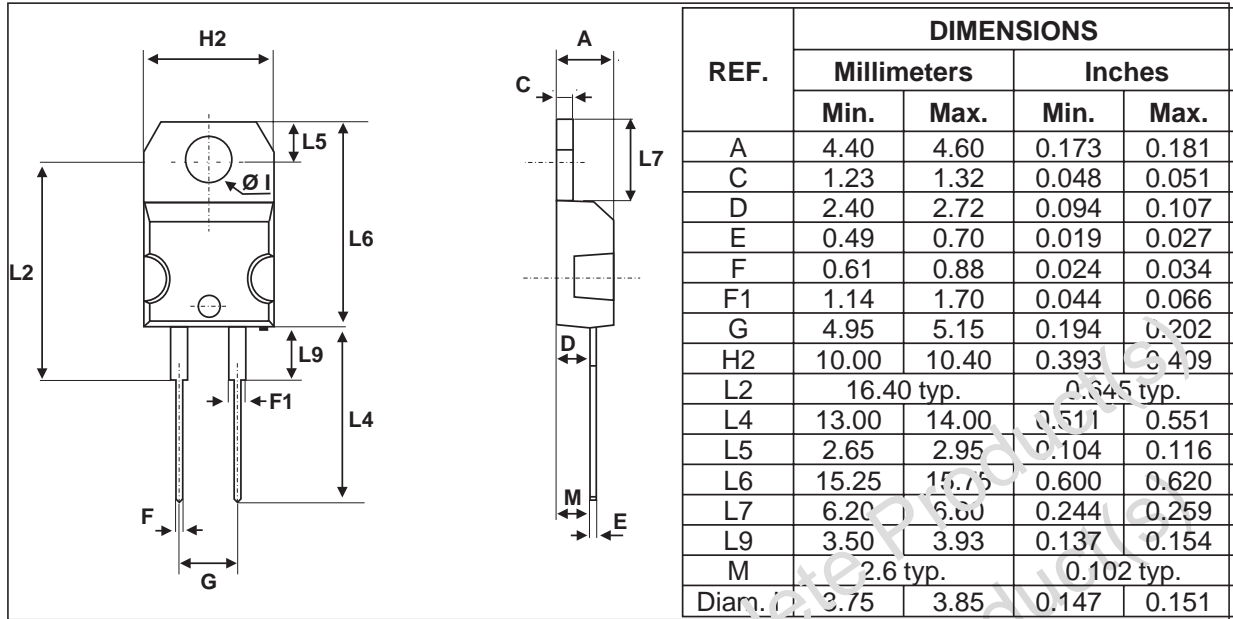

Fig. 12: Dynamic parameters versus junction temperature.



PACKAGE MECHANICAL DATA
TO-220AC (JEDEC outline)



- **Marking** : Type number
- Cooling method : C
- Weight : 1.9 g
- Recommended torque value : 0.8m.N
- Maximum torque value : 1.0m.N

PACKAGE MECHANICAL DATA
TO-220AC (isolated)

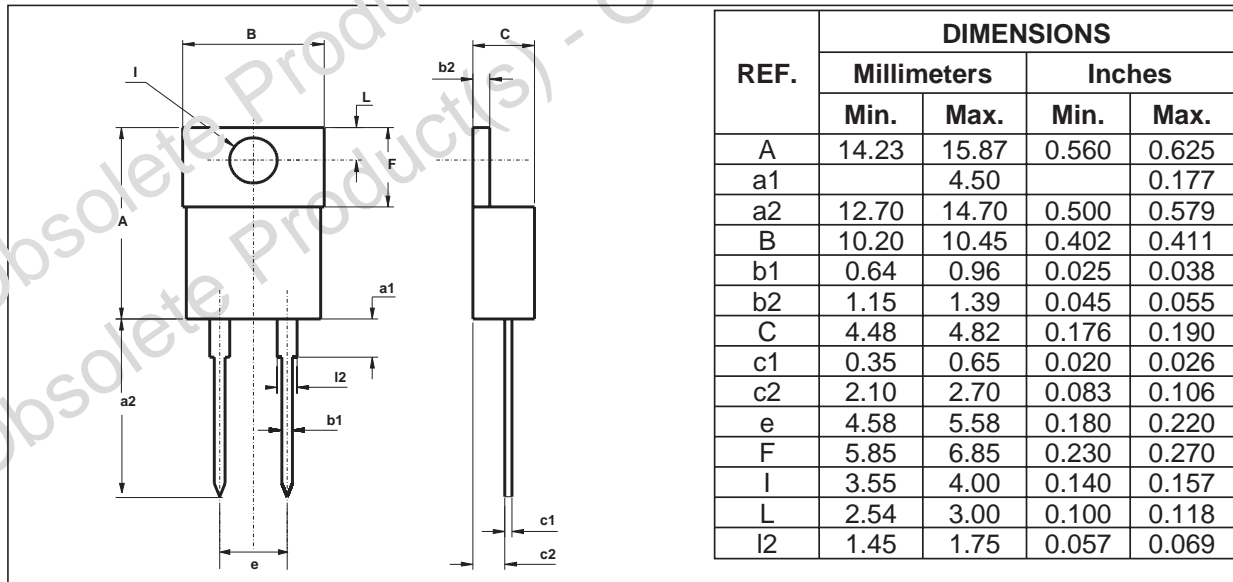

- **Marking** : Type number
- Cooling method : C
- Weight : 2.2 g
- Recommended torque value : 0.8m.N
- Maximum torque value : 1.0m.N



BYW81P-200 / BYW81PI-200 / BYW81G-200

PACKAGE MECHANICAL DATA

D²PAK (Plastic)

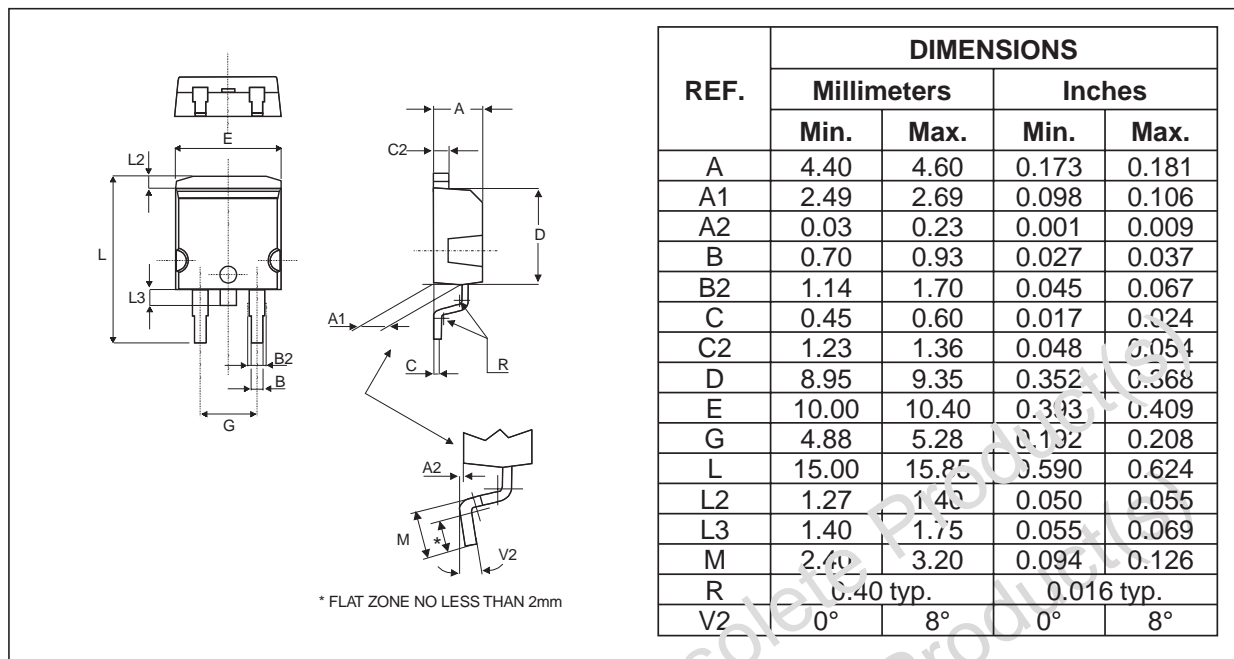

- Cooling method: by conduction (method C)

FOOT PRINT DIMENSIONS (in millimeters)

D²PAK

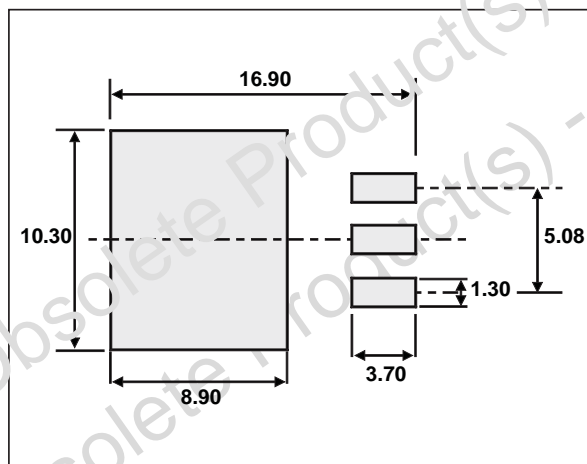

Information furnished is believed to be accurate and reliable. However, STMicroelectronics assumes no responsibility for the consequences of use of such information nor for any infringement of patents or other rights of third parties which may result from its use. No license is granted by implication or otherwise under any patent or patent rights of STMicroelectronics. Specifications mentioned in this publication are subject to change without notice. This publication supersedes and replaces all information previously supplied. STMicroelectronics products are not authorized for use as critical components in life support devices or systems without express written approval of STMicroelectronics.

The ST logo is a registered trademark of STMicroelectronics
 © 2002 STMicroelectronics - Printed in Italy - All rights reserved.
 STMicroelectronics GROUP OF COMPANIES
 Australia - Brazil - Canada - China - Finland - France - Germany
 Hong Kong - India - Israel - Italy - Japan - Malaysia - Malta - Morocco - Singapore
 Spain - Sweden - Switzerland - United Kingdom - United States.

<http://www.st.com>

