

BZT52BXXXS

Rev.F Mar.-2016

描述 / Descriptions

SOD-323 塑封封装 稳压二极管。

Zener Diode in a SOD-323 Plastic Package.

特征 / Features

200mW 功耗, 中等电流, 自动贴片组装。

200mW power dissipation, medium current, automated assembly processes.

用途 / Applications

适用于 2.4V-39V 的宽范围稳压电路。

2.4V to 39V wide zener voltage range applications.

内部等效电路 / Equivalent Circuit

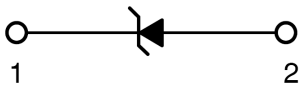

引脚排列 / Pinning



PIN1:Cathode

PIN2:Anode

放大及印章代码 / h_{FE} Classifications & Marking

见电性能参数。 See Electrical Characteristics.

极限参数 / Absolute Maximum Ratings(Ta=25°C)

参数 Parameter	符号 Symbol	数值 Rating	单位 Unit
Forward Voltage (Note 2) $I_F=10\text{mA}$	V_F	0.9	V
Power Dissipation(Note 1)	P_D	200	mW
Typical Thermal Resistance Junction to Ambient(Note 1)	$R_{\theta JA}$	625	°C/W
Junction and Storage Temperature Range	T_j, T_{stg}	-65~150	°C

电性能参数 / Electrical Characteristics(Ta=25°C)

Type Number	Marking Code	Zener Voltage Range (Note 2)				Maximum Zener Impedance (Note 3)			Maximum Reverse Current	
		$V_z @ I_{ZT}$			I_{ZT}	$Z_{ZT} @ I_{ZT}$	$Z_{ZK} @ I_{ZK}$	I_{ZK}	I_R	@ V_R
		Nom (V)	Min (V)	Max (V)	mA	Ω		mA	μA	V
BZT52B2V4S	H0Z	2.4	2.35	2.45	5	94	564	1	45	1
BZT52B2V7S	H1Z	2.7	2.65	2.75	5	94	564	1	18	1
BZT52B3V0S	H2Z	3.0	2.94	3.06	5	89	564	1	9	1
BZT52B3V3S	H3Z	3.3	3.23	3.37	5	89	564	1	4.5	1
BZT52B3V6S	H4Z	3.6	3.53	3.67	5	84	564	1	4.5	1
BZT52B3V9S	H5Z	3.9	3.82	3.96	5	84	564	1	2.7	1
BZT52B4V3S	H6Z	4.3	4.21	4.39	5	84	564	1	2.7	1
BZT52B4V7S	H7Z	4.7	4.61	4.79	5	75	564	1	2.7	2
BZT52B5V1S	H8Z	5.1	5.00	5.20	5	56	470	1	1.8	2
BZT52B5V6S	H9Z	5.6	5.49	5.71	5	27	451	1	0.9	2
BZT52B6V2S	HAZ	6.2	6.08	6.32	5	9	376	1	2.7	4
BZT52B6V8S	HBZ	6.8	6.66	6.94	5	14	141	1	1.8	4
BZT52B7V5S	HCZ	7.5	7.35	7.65	5	14	75	1	0.9	5
BZT52B8V2S	HDZ	8.2	8.04	8.36	5	14	75	1	0.63	5
BZT52B9V1S	HEZ	9.1	8.92	9.28	5	14	94	1	0.45	6
BZT52B10S	HFZ	10	9.80	10.20	5	18	141	1	0.18	7
BZT52B11S	HGZ	11	10.78	11.22	5	18	141	1	0.09	8

电性能参数 / Electrical Characteristics(Ta=25°C)

Type Number	Marking Code	Zener Voltage Range (Note 2)				Maximum Zener Impedance (Note 3)			Maximum Reverse Current	
		V _z @I _{ZT}			I _{ZT}	Z _{ZT} @I _{ZT}	Z _{ZK} @I _{ZK}	I _{ZK}	I _R	@V _R
		Nom (V)	Min (V)	Max (V)	mA	Ω		mA	μA	V
BZT52B12S	HHZ	12	11.76	12.24	5	23	141	1	0.09	8
BZT52B13S	HJZ	13	12.74	13.26	5	28	160	1	0.045	8
BZT52B15S	HKZ	15	14.70	15.30	5	28	188	1	0.045	10.5
BZT52B16S	HLZ	16	15.68	16.32	5	37	188	1	0.045	11.2
BZT52B18S	HMZ	18	17.64	18.36	5	42	212	1	0.045	12.6
BZT52B20S	HNZ	20	19.60	20.40	5	51	212	1	0.045	14.0
BZT52B22S	HPZ	22	21.56	22.44	5	51	235	1	0.045	15.4
BZT52B24S	HRZ	24	23.52	24.48	5	65	235	1	0.045	16.8
BZT52B27S	HSZ	27	26.46	27.54	5	75	282	0.5	0.045	18.9
BZT52B30S	HTZ	30	29.40	30.60	5	75	282	0.5	0.045	21.0
BZT52B33S	HUZ	33	32.34	33.66	5	75	306	0.5	0.045	23.0
BZT52B36S	HVZ	36	35.28	36.72	5	84	329	0.5	0.045	25.2
BZT52B39S	HWZ	39	38.22	39.78	5	122	329	0.5	0.045	27.3

Notes:

1. Device mounted on ceramic PCB; 7.6mm x 9.4mm x 0.87mm with pad areas 25mm².
2. Short duration test pulse used to minimize self-heating effect.
3. f = 1kHz.

电参数曲线图 / Electrical Characteristic Curve

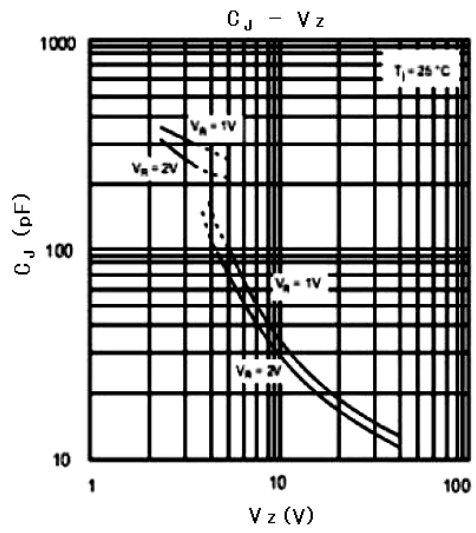
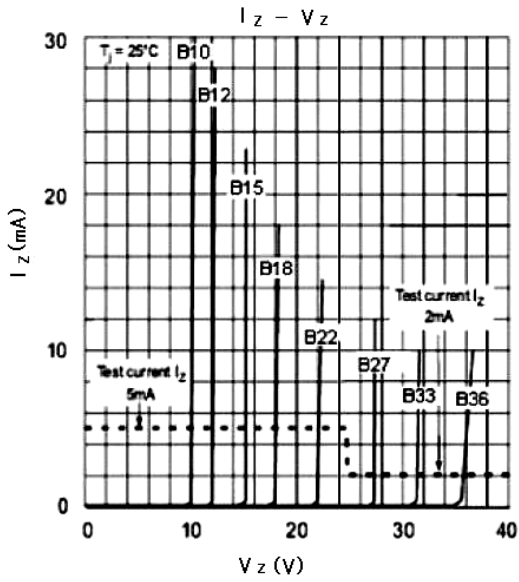
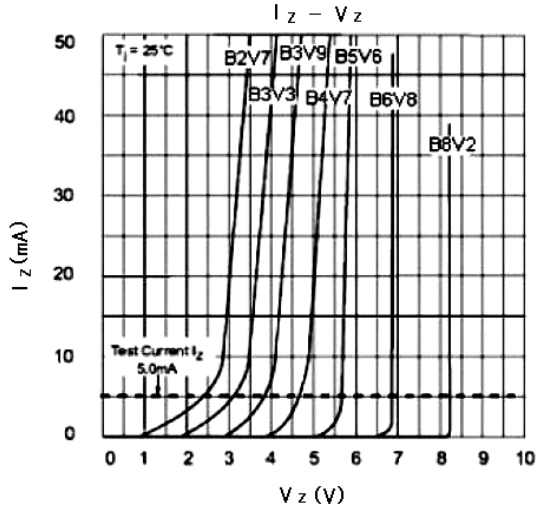
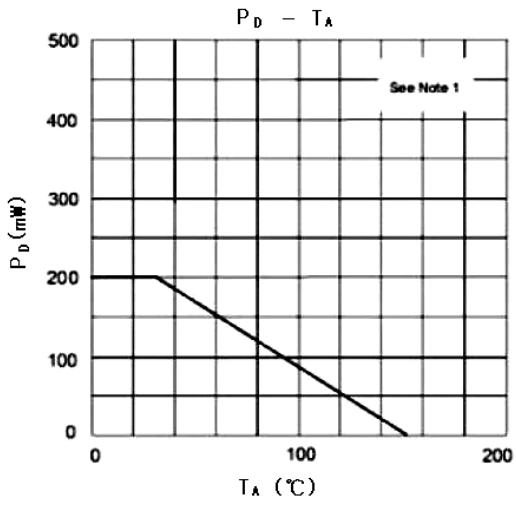

外形尺寸图 / Package Dimensions

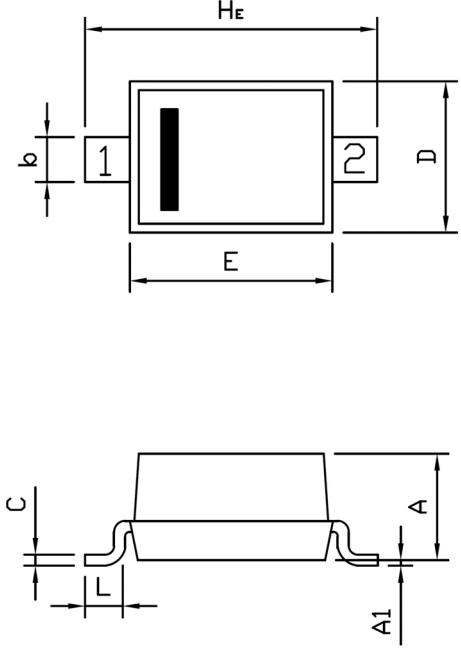

Unit: mm

尺寸 符号	SOD-323	
	min	max
A	0.90	1.10
A1	0.00	0.10
b	0.25	0.40
C	0.089	0.177
D	1.15	1.35
E	1.60	1.80
HE	2.30	2.70
L	0.20	0.40

PIN: 1.CATHODE 2.ANODE

SOD-323

印章说明 / Marking Instructions

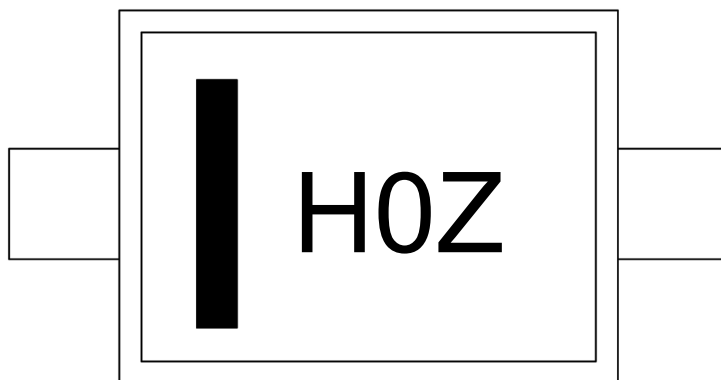

说明：

H： 为公司代码

OZ： 为型号代码

Note:

H: Company Code.

OZ: Product Type.

回流焊温度曲线图(无铅) / Temperature Profile for IR Reflow Soldering(Pb-Free)



说明：

- 1、预热温度 25~150°C，时间 60~90sec;
- 2、峰值温度 245±5°C，时间持续为 5±0.5sec;
- 3、焊接制程冷却速度为 2~10°C/sec.

Note:

- 1.Preheating:25~150°C, Time:60~90sec.
- 2.Peak Temp.:245±5°C, Duration:5±0.5sec.
3. Cooling Speed: 2~10°C/sec.

耐焊接热试验条件 / Resistance to Soldering Heat Test Conditions

温度：260±5°C

时间：10±1 sec.

Temp.:260±5°C

Time:10±1 sec

包装规格 / Packaging SPEC.

卷盘包装 / REEL

Package Type 封装形式	Units 包装数量					Dimension 包装尺寸 (unit: mm ³)		
	Units/Reel 只/卷盘	Reels/Inner Box 卷盘/盒	Units/Inner Box 只/盒	Inner Boxes/Outer Box 盒/箱	Units/Outer Box 只/箱	Reel	Inner Box 盒	Outer Box 箱
SOD-323	3,000	10	30,000	8	240,000	7" ×8	180×120×180	385×257×392

使用说明 / Notices