

Features

- Planar Die Construction
- 200mW Power Dissipation
- 2.4V – 75V Nominal Zener Voltage
- 2% Standard Vz Tolerance
- Designed for Surface Mount Application
- Plastic Material – UL Recognition Flammability Classification 94V-0

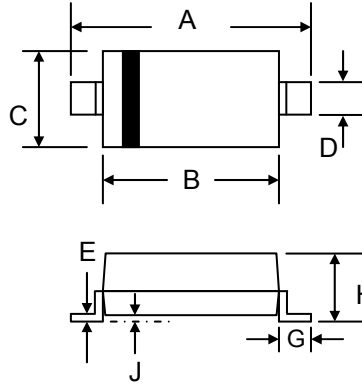

SOD-323		
Dim	Min	Max
A	2.30	2.75
B	1.60	1.80
C	1.15	1.35
D	0.25	0.40
E	0.09	0.18
G	0.20	0.40
H	0.80	1.00
J	—	0.12
All Dimensions in mm		

Mechanical Data

- Case: SOD-323, Molded Plastic
- Terminals: Plated Leads Solderable per MIL-STD-202, Method 208
- Polarity: Cathode Band
- Weight: 0.004 grams (approx.)
- Marking: Device Code
- **Lead Free: For RoHS / Lead Free Version, Add “-LF” Suffix to Part Number, See Page 5**

Maximum Ratings @ $T_A=25^{\circ}\text{C}$ unless otherwise specified

Characteristic	Symbol	Value	Unit
Power Dissipation at $T_A = 25^{\circ}\text{C}$ (Note 1)	P_D	200	mW
Forward Voltage @ $I_F = 10\text{mA}$	V_F	0.9	V
Thermal Resistance, Junction to Ambient (Note 1, 2)	R_{JA}	625	$^{\circ}\text{C}/\text{W}$
Operating and Storage Temperature Range	T_J, T_{STG}	-65 to +150	$^{\circ}\text{C}$

Note: 1. Mounted on FR-4 PCB with minimum recommended pad layout.
2. Thermal resistance measurement obtained via infrared scan method.

BZT52B2V4S – BZT52B75S

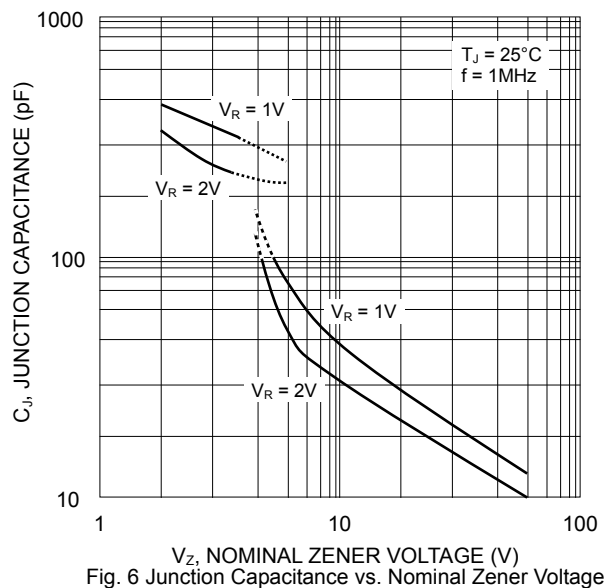
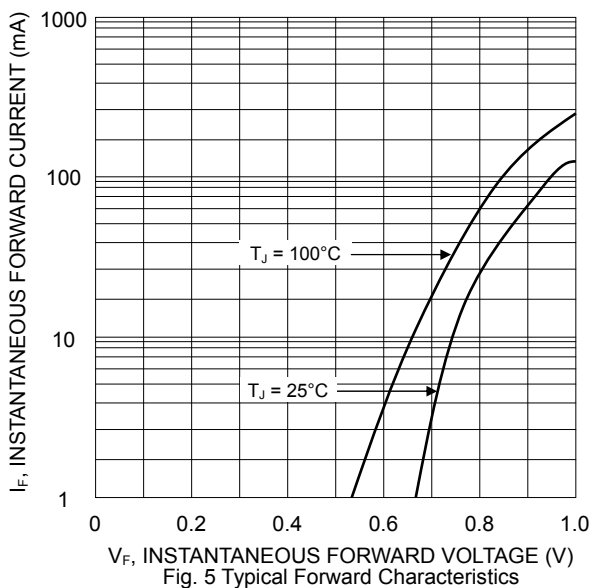
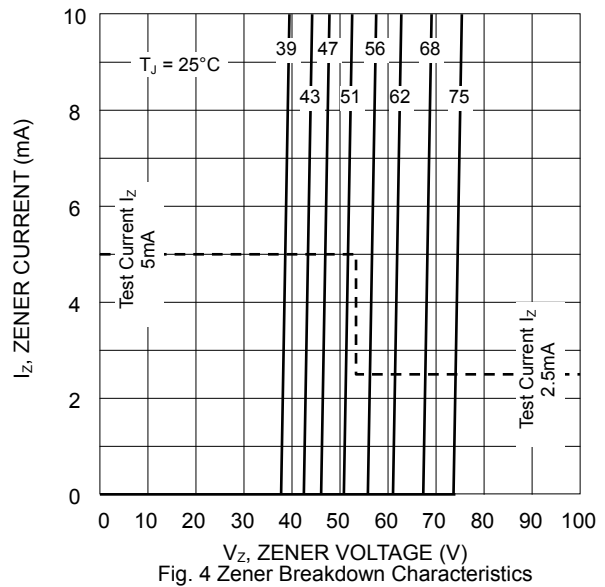
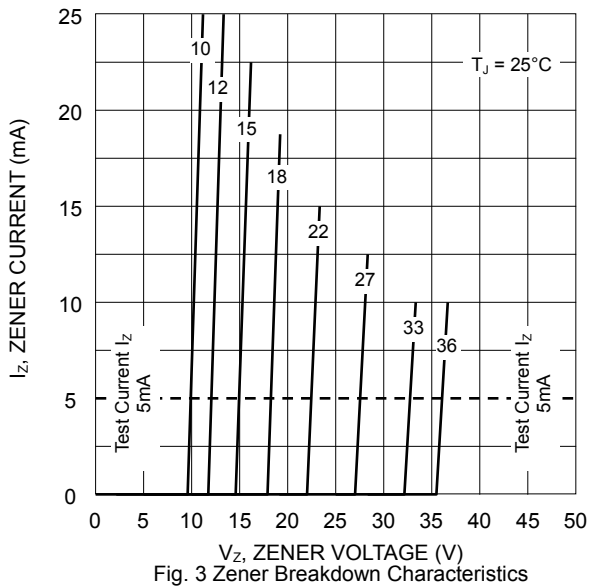
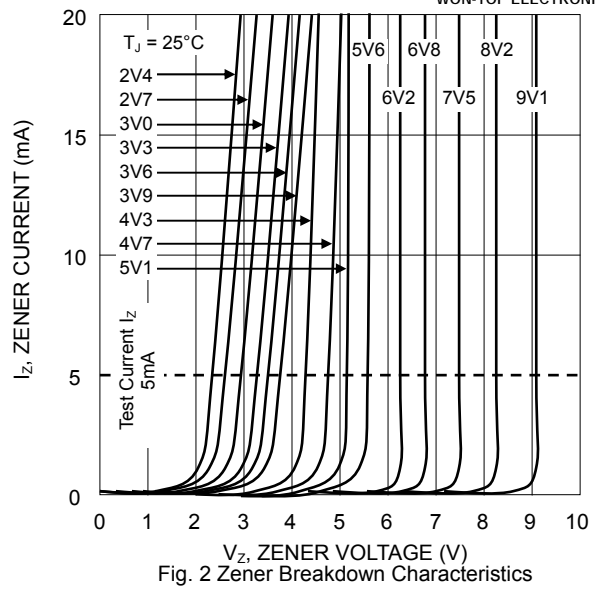
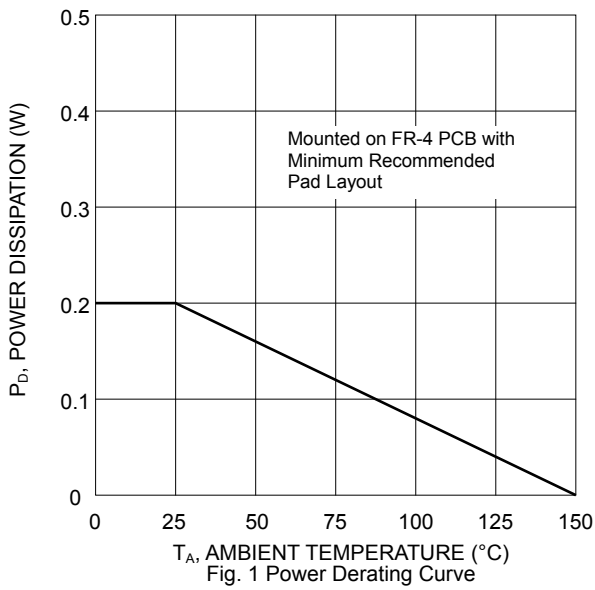

Electrical Characteristics (@T_A=25°C unless otherwise specified) Table 1

Type Number (Note 1)	Device Marking Code (Note 2)		Zener Voltage Range (Note 3)			Maximum Zener Impedance (Note 4)				Max Reverse Leakage Current		Temp. Coefficient of Zener Voltage @ I _{ZT} (mV/°C)	
			V _Z @ I _{ZT}			Z _{ZT} @ I _{ZT}		Z _{ZK} @ I _{ZK}		I _R	@ V _R		
	TW	CN	Nom (V)	Min (V)	Max (V)	()	(mA)	()	(mA)	(μA)	(V)	Min	Max
BZT52B2V4S	W1	OZ	2.4	2.35	2.45	85	5.0	600	1.0	100	1.0	-9	-4
BZT52B2V7S	W2	1Z	2.7	2.65	2.75	83	5.0	500	1.0	75	1.0	-9	-4
BZT52B3V0S	W3	2Z	3.0	2.94	3.06	95	5.0	500	1.0	50	1.0	-9	-3
BZT52B3V3S	W4	3Z	3.3	3.23	3.37	95	5.0	500	1.0	25	1.0	-8	-3
BZT52B3V6S	W5	4Z	3.6	3.53	3.67	95	5.0	500	1.0	15	1.0	-8	-3
BZT52B3V9S	W6	5Z	3.9	3.82	3.98	95	5.0	500	1.0	10	1.0	-7	-3
BZT52B4V3S	W7	6Z	4.3	4.21	4.39	95	5.0	500	1.0	5.0	1.0	-6	-1
BZT52B4V7S	W8	7Z	4.7	4.61	4.79	78	5.0	500	1.0	5.0	1.0	-5	+2
BZT52B5V1S	W9	8Z	5.1	5.00	5.20	60	5.0	480	1.0	0.1	0.8	-3	+4
BZT52B5V6S	WA	9Z	5.6	5.49	5.71	40	5.0	400	1.0	0.1	1.0	-2	+6
BZT52B6V2S	WB	AZ	6.2	6.08	6.32	10	5.0	200	1.0	0.1	2.0	-1	+7
BZT52B6V8S	WC	BZ	6.8	6.66	6.94	8	5.0	150	1.0	0.1	3.0	+2	+7
BZT52B7V5S	WD	CZ	7.5	7.35	7.65	7	5.0	50	1.0	0.1	5.0	+3	+7
BZT52B8V2S	WE	DZ	8.2	8.04	8.36	7	5.0	50	1.0	0.1	6.0	+4	+7
BZT52B9V1S	WF	EZ	9.1	8.92	9.28	10	5.0	50	1.0	0.1	7.0	+5	+8
BZT52B10S	WG	FZ	10	9.80	10.20	15	5.0	70	1.0	0.1	7.5	+5	+8
BZT52B11S	WH	GZ	11	10.78	11.22	20	5.0	70	1.0	0.1	8.5	+5	+9
BZT52B12S	WI	HZ	12	11.76	12.24	20	5.0	90	1.0	0.1	9.0	+6	+9
BZT52B13S	WK	JZ	13	12.74	13.26	25	5.0	110	1.0	0.1	10	+7	+9
BZT52B15S	WL	KZ	15	14.70	15.30	30	5.0	110	1.0	0.1	11	+7	+9
BZT52B16S	WM	LZ	16	15.68	16.32	40	5.0	170	1.0	0.1	12	+8	+9.5
BZT52B18S	WN	MZ	18	17.64	18.36	50	5.0	170	1.0	0.1	14	+8	+9.5
BZT52B20S	WO	NZ	20	19.60	20.40	50	5.0	220	1.0	0.1	15	+8	+10
BZT52B22S	WP	PZ	22	21.56	22.44	55	5.0	220	1.0	0.1	17	+8	+10
BZT52B24S	WR	RZ	24	23.52	24.48	80	5.0	220	1.0	0.1	18	+8	+10
BZT52B27S	WS	SZ	27	26.46	27.54	80	5.0	250	1.0	0.1	20	+8	+10
BZT52B30S	WT	TZ	30	29.40	30.60	80	5.0	250	1.0	0.1	22.5	+8	+10
BZT52B33S	WU	UZ	33	32.34	33.66	80	5.0	250	1.0	0.1	25	+8	+10
BZT52B36S	WW	VZ	36	35.28	36.72	90	5.0	250	1.0	0.1	27	+8	+10
BZT52B39S	WX	WZ	39	38.22	39.78	90	5.0	300	1.0	0.1	29	+10	+12
BZT52B43S	WY	XZ	43	42.14	43.86	100	5.0	700	1.0	0.1	32	+10	+12
BZT52B47S	WZ	YZ	47	46.06	47.94	100	5.0	750	1.0	0.1	35	+10	+12
BZT52B51S	XA	-Z	51	49.98	52.02	100	5.0	750	1.0	0.1	38	+10	+12
BZT52B56S	X2	=Z	56	54.88	57.12	135	2.5	1000	0.5	0.1	42	+10	-
BZT52B62S	X3	≡Z	62	60.76	63.24	150	2.5	1000	0.5	0.1	46	+10	-
BZT52B68S	X4	>Z	68	66.64	69.36	200	2.5	1000	0.5	0.1	51	+10	-
BZT52B75S	X5	<Z	75	73.50	76.50	250	2.5	1500	0.5	0.1	56	+10	-

- Note: 1. Type numbers listed have standard tolerance on the nominal zener voltage of ±2%.
 2. TW: Marking code for Taiwan plant. CN: Marking code for China plant.
 3. Measured with pulses t_p = 5ms.
 4. f = 1KHz

MARKING INFORMATION



Cathode = Polarity Band
xx = Device Code, Table 1

RECOMMENDED FOOTPRINT

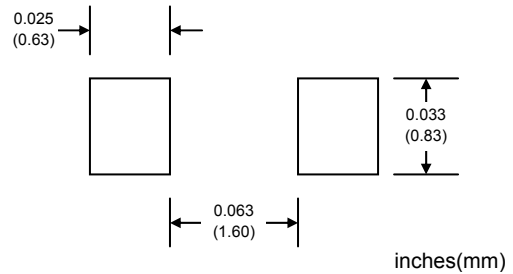

PACKAGING INFORMATION

TAPE & REEL

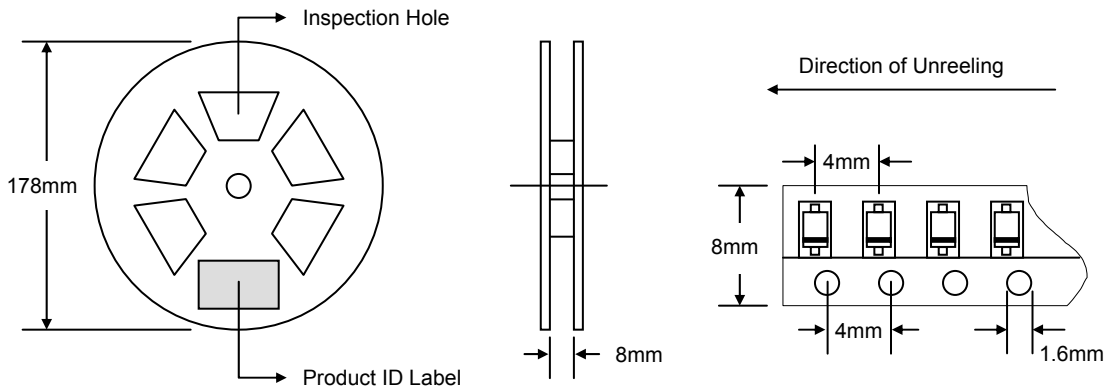

Reel Diameter (mm)	Quantity (PCS)	Inner Box Size L x W x H (mm)	Quantity (PCS)	Carton Size L x W x H (mm)	Quantity (PCS)	Approx. Gross Weight (KG)
178	3,000	187 x 187 x 65	15,000	390 x 240 x 420	150,000	7.0

Note: 1. Anti-static plastic reel, white, water clear or blue color. Inspection hole might be varied in different alignment.
2. Components are packed in accordance with EIA standard 481-1 and 481-2.

ORDERING INFORMATION

Product No.	Package Type	Shipping Quantity
BZT52BxxS-T1	SOD-323	3000/Tape & Reel

1. Shipping quantity given is for minimum packing quantity only. For minimum order quantity, please consult the Sales Department.
2. **To order RoHS / Lead Free version (with Lead Free finish), add "-LF" suffix to part number above. For example, BZT52B2V4S-T1-LF.**

WON-TOP ELECTRONICS and  are registered trademarks of Won-Top Electronics Co., Ltd (WTE). WTE has checked all information carefully and believes it to be correct and accurate. However, WTE cannot assume any responsibility for inaccuracies. Furthermore, this information does not give the purchaser of semiconductor devices any license under patent rights to manufacturer. WTE reserves the right to change any or all information herein without further notice.

WARNING: DO NOT USE IN LIFE SUPPORT EQUIPMENT. WTE power semiconductor products are not authorized for use as critical components in life support devices or systems without the express written approval.

Won-Top Electronics Co., Ltd.
No. 44 Yu Kang North 3rd Road,
Chine Chen Dist., Kaohsiung 806, Taiwan
Phone: 886-7-822-5408 or 886-7-822-5410
Fax: 886-7-822-5417
Email: sales@wontop.com
Internet: <http://www.wontop.com>

We power your everyday.