

Zener Diodes

BZT55B2V4 ~ BZT55B75

■ Features

- Very sharp reverse characteristic
- Low reverse current level
- Very high stability
- Low noise

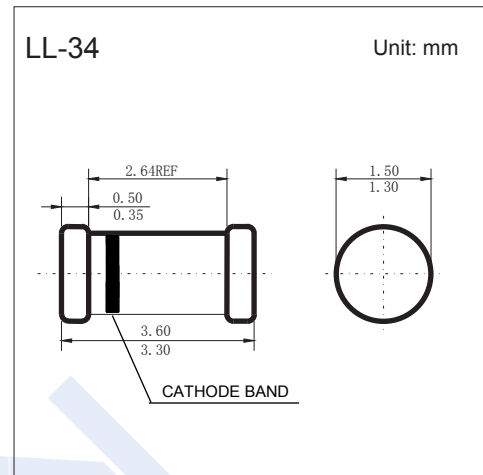

■ Absolute Maximum Ratings $T_a = 25^\circ\text{C}$

Parameter	Symbol	Rating	Unit
Forward voltage @ $I_F=200\text{mA}$	V_F	1.5	V
Zener current	I_Z	P_v/V_z	mA
Power Dissipation @ $R_{\theta JA} \leq 300^\circ\text{C/W}$	P_D	500	mW
Thermal Resistance Junction to Ambient	$R_{\theta JA}$	500	$^\circ\text{C/W}$
Junction Temperature	T_J	175	$^\circ\text{C}$
Storage Temperature range	T_{stg}	-65 to 175	

Zener Diodes

BZT55B2V4 ~ BZT55B75

■ Electrical Characteristics Ta = 25°C

PART NUMBER	ZENER VOLTAGE RANGE ⁽¹⁾			TEST CURRENT		REVERSE LEAKAGE CURRENT			DYNAMIC RESISTANCE		TEMPERATURE COEFFICIENT	
	V _Z at I _{ZT1}			I _{ZT1}	I _{ZT2}	I _R at V _R			Z _Z at I _{ZT1}	Z _{ZK} at I _{ZT2}	TK _{VZ}	
	V			mA		μA		V	Ω		%K	
	MIN.	NOM.	MAX.						MAX.	MAX.	MIN.	MAX.
BZT55B2V4	2.35	2.4	2.45	5	1	< 50	< 100	1	< 85	< 600	- 0.09	- 0.06
BZT55B2V7	2.64	2.7	2.76	5	1	< 10	< 50	1	< 85	< 600	- 0.09	- 0.06
BZT55B3V0	2.94	3.0	3.06	5	1	< 4	< 40	1	< 90	< 600	- 0.08	- 0.05
BZT55B3V3	3.24	3.3	3.36	5	1	< 2	< 40	1	< 90	< 600	- 0.08	- 0.05
BZT55B3V6	3.52	3.6	3.68	5	1	< 2	< 40	1	< 90	< 600	- 0.08	- 0.05
BZT55B3V9	3.82	3.9	3.98	5	1	< 2	< 40	1	< 90	< 600	- 0.08	- 0.05
BZT55B4V3	4.22	4.3	4.38	5	1	< 1	< 20	1	< 90	< 600	- 0.06	- 0.03
BZT55B4V7	4.6	4.7	4.8	5	1	< 0.5	< 10	1	< 80	< 600	- 0.05	0.02
BZT55B5V1	5	5.1	5.2	5	1	< 0.1	< 2	1	< 60	< 550	- 0.02	0.02
BZT55B5V6	5.48	5.6	5.72	5	1	< 0.1	< 2	1	< 40	< 450	- 0.05	0.05
BZT55B6V2	6.08	6.2	6.32	5	1	< 0.1	< 2	2	< 10	< 200	0.03	0.06
BZT55B6V8	6.66	6.8	6.94	5	1	< 0.1	< 2	3	< 8	< 150	0.03	0.07
BZT55B7V5	7.35	7.5	7.65	5	1	< 0.1	< 2	5	< 7	< 50	0.03	0.07
BZT55B8V2	8.04	8.2	8.36	5	1	< 0.1	< 2	6.2	< 7	< 50	0.03	0.08
BZT55B9V1	8.92	9.1	9.28	5	1	< 0.1	< 2	6.8	< 10	< 50	0.03	0.09
BZT55B10	9.8	10	10.2	5	1	< 0.1	< 2	7.5	< 15	< 70	0.03	0.1
BZT55B11	10.78	11	11.22	5	1	< 0.1	< 2	8.2	< 20	< 70	0.03	0.11
BZT55B12	11.76	12	12.24	5	1	< 0.1	< 2	9.1	< 20	< 90	0.03	0.11
BZT55B13	12.74	13	13.26	5	1	< 0.1	< 2	10	< 26	< 110	0.03	0.11
BZT55B15	14.7	15	15.3	5	1	< 0.1	< 2	11	< 30	< 110	0.03	0.11
BZT55B16	15.7	16	16.3	5	1	< 0.1	< 2	12	< 40	< 170	0.03	0.11
BZT55B18	17.64	18	18.36	5	1	< 0.1	< 2	13	< 50	< 170	0.03	0.11
BZT55B20	19.6	20	20.4	5	1	< 0.1	< 2	15	< 55	< 220	0.03	0.11
BZT55B22	21.55	22	22.45	5	1	< 0.1	< 2	16	< 55	< 220	0.04	0.12
BZT55B24	23.5	24	24.5	5	1	< 0.1	< 2	18	< 80	< 220	0.04	0.12
BZT55B27	26.4	27	27.6	5	1	< 0.1	< 2	20	< 80	< 220	0.04	0.12
BZT55B30	29.4	30	30.6	5	1	< 0.1	< 2	22	< 80	< 220	0.04	0.12
BZT55B33	32.4	33	33.6	5	1	< 0.1	< 2	24	< 80	< 220	0.04	0.12
BZT55B36	35.3	36	36.7	5	1	< 0.1	< 2	27	< 80	< 220	0.04	0.12
BZT55B39	38.2	39	39.8	2.5	1	< 0.1	< 5	30	< 90	< 500	0.04	0.12
BZT55B43	42.1	43	43.9	2.5	0.5	< 0.1	< 5	33	< 90	< 600	0.04	0.12
BZT55B47	46.1	47	47.9	2.5	0.5	< 0.1	< 5	36	< 110	< 700	0.04	0.12
BZT55B51	50	51	52	2.5	0.5	< 0.1	< 10	39	< 125	< 700	0.04	0.12
BZT55B56	54.9	56	57.1	2.5	0.5	< 0.1	< 10	43	< 135	< 1000	0.04	0.12
BZT55B62	60.8	62	63.2	2.5	0.5	< 0.1	< 10	47	< 150	< 1000	0.04	0.12
BZT55B68	66.6	68	69.4	2.5	0.5	< 0.1	< 10	51	< 200	< 1000	0.04	0.12
BZT55B75	73.5	75	76.5	2.5	0.5	< 0.1	< 10	56	< 250	< 1500	0.04	0.12

Notes

• Additional measurement of volt age group 9V1 to 75 at 95 % V_{zmin.} ≤ 35 nA at T_j 25 °C

⁽¹⁾ t_p ≤ 10 ms, T/t_p > 1000

Zener Diodes

BZT55B2V4 ~ BZT55B75

■ Typical Characteristics

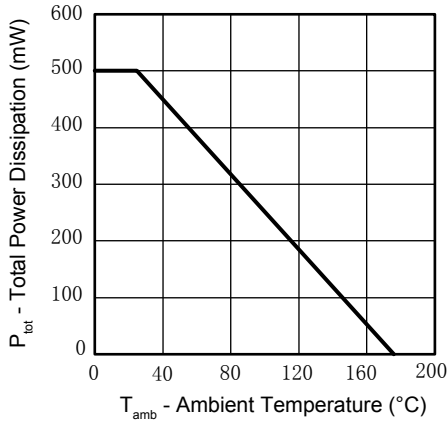

Fig. 1 - Total Power Dissipation vs. Ambient Temperature

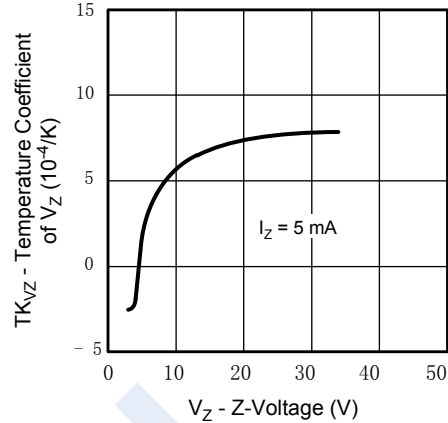

Fig. 4 - Temperature Coefficient of V_Z vs. Z-Voltage

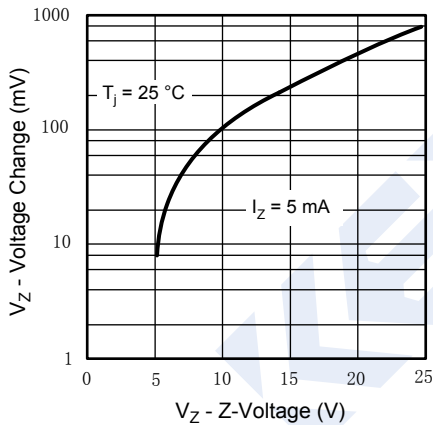

Fig. 2 - Typical Change of Working Voltage under Operating Conditions at $T_{amb}=25^{\circ}C$

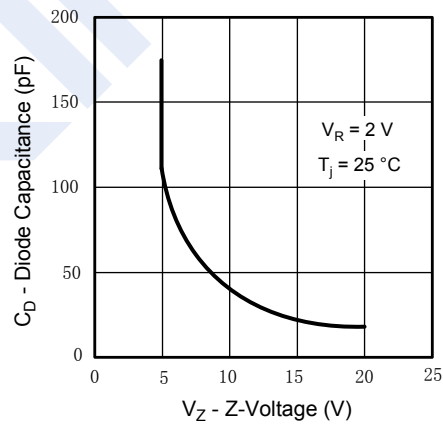

Fig. 5 - Diode Capacitance vs. Z-Voltage

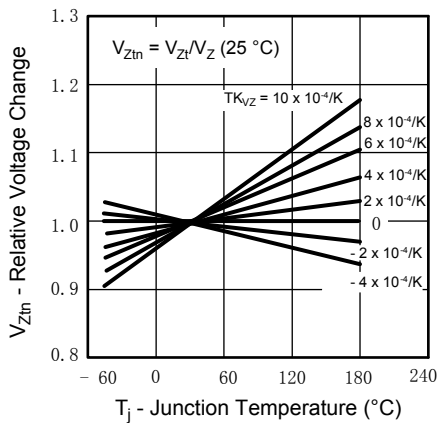

Fig. 3 - Typical Change of Working Voltage vs. Junction Temperature

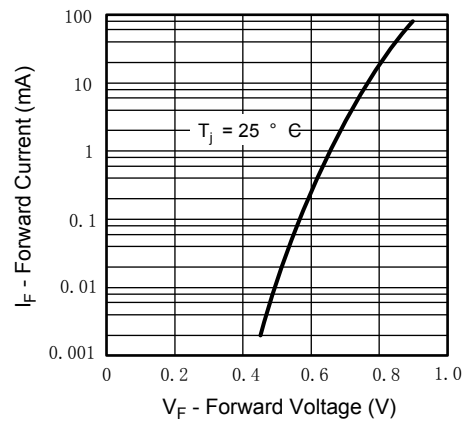

Fig. 6 - Forward Current vs. Forward Voltage

Zener Diodes

BZT55B2V4 ~ BZT55B75

■ Typical Characteristics

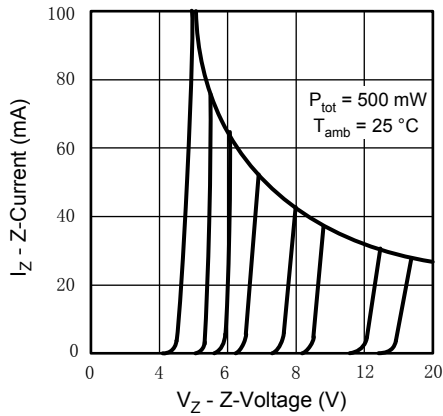

Fig. 7 - Z-Current vs. Z-Voltage

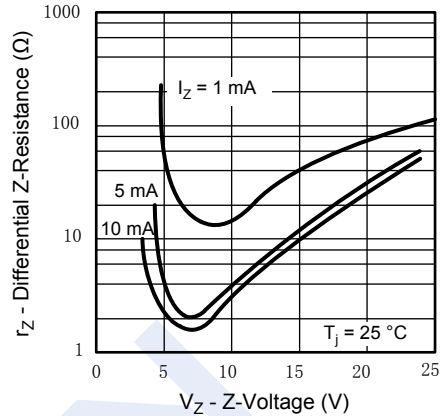

Fig. 9 - Differential Z-Resistance vs. Z-Voltage

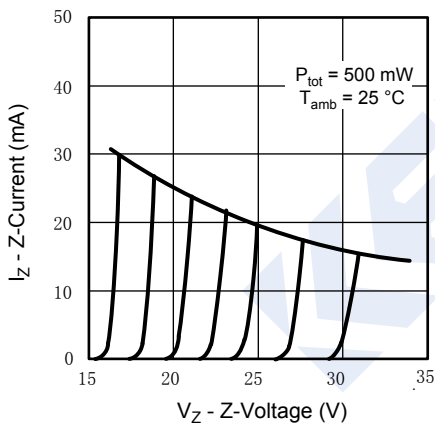

Fig. 8 - Z-Current vs. Z-Voltage

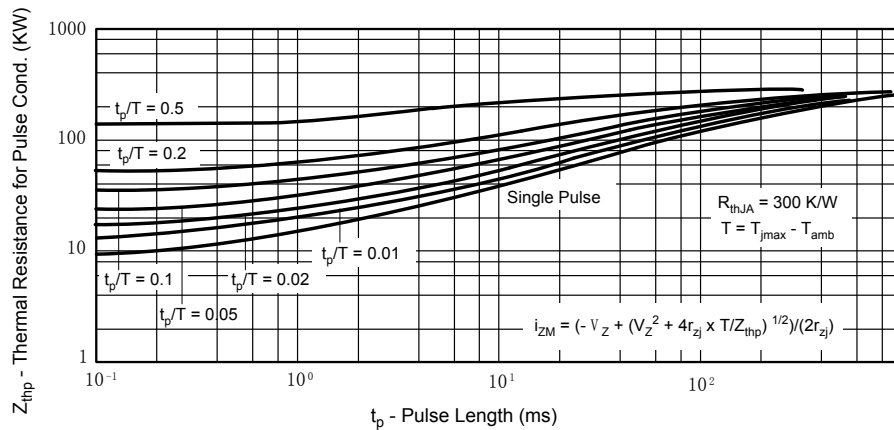

Fig. 10 - Thermal Response