

Silicon Epitaxial Planar Z-Diodes

Features

- Very sharp reverse characteristic
- Low reverse current level
- Very high stability
- Low noise
- Available with tighter tolerances

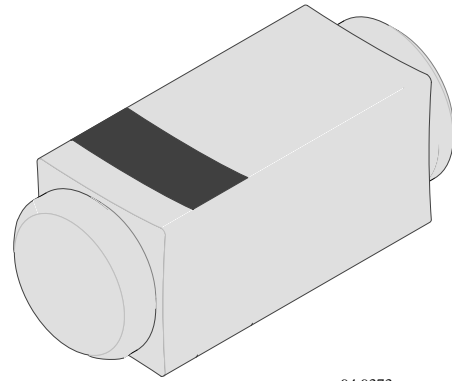

94 9373

Applications

Voltage stabilization

Absolute Maximum Ratings

$T_j = 25^\circ\text{C}$

Parameter	Test Conditions	Type	Symbol	Value	Unit
Power dissipation	$R_{thJA} \leq 300\text{K/W}$		P_V	500	mW
Z-current			I_Z	P_V/V_Z	mA
Junction temperature			T_j	175	$^\circ\text{C}$
Storage temperature range			T_{stg}	-65...+175	$^\circ\text{C}$

Maximum Thermal Resistance

$T_j = 25^\circ\text{C}$

Parameter	Test Conditions	Symbol	Value	Unit
Junction ambient	on PC board 50mmx50mmx1.6mm	R_{thJA}	500	K/W

Characteristics

$T_j = 25^\circ\text{C}$

Parameter	Test Conditions	Type	Symbol	Min	Typ	Max	Unit
Forward voltage	$I_F=200\text{mA}$		V_F			1.5	V

Type BZT55C...	V _{Znorm} V	I _{ZT} for mA	V _{ZT} ¹⁾ V	and r _{zjT} Ω	r _{zjk} Ω	at I _{ZK} mA	I _R μA	and I _R ²⁾ μA	at V _R V	TK _{VZ} %/K
2 V 4	2.4	5	2.28 to 2.56	< 85	< 600	1	< 100	< 50	1	-0.09 to -0.06
2 V 7	2.7	5	2.5 to 2.9	< 85	< 600	1	< 10	< 50	1	-0.09 to -0.06
3 V 0	3.0	5	2.8 to 3.2	< 90	< 600	1	< 4	< 40	1	-0.08 to -0.05
3 V 3	3.3	5	3.1 to 3.5	< 90	< 600	1	< 2	< 40	1	-0.08 to -0.05
3 V 6	3.6	5	3.4 to 3.8	< 90	< 600	1	< 2	< 40	1	-0.08 to -0.05
3 V 9	3.9	5	3.7 to 4.1	< 90	< 600	1	< 2	< 40	1	-0.08 to -0.05
4 V 3	4.3	5	4.0 to 4.6	< 90	< 600	1	< 1	< 20	1	-0.06 to -0.03
4 V 7	4.7	5	4.4 to 5.0	< 80	< 600	1	< 0.5	< 10	1	-0.05 to +0.02
5 V 1	5.1	5	4.8 to 5.4	< 60	< 550	1	< 0.1	< 2	1	-0.02 to +0.02
5 V 6	5.6	5	5.2 to 6.0	< 40	< 450	1	< 0.1	< 2	1	-0.05 to +0,05
6 V 2	6.2	5	5.8 to 6.6	< 10	< 200	1	< 0.1	< 2	2	0.03 to 0.06
6 V 8	6.8	5	6.4 to 7.2	< 8	< 150	1	< 0.1	< 2	3	0.03 to 0.07
7 V 5	7.5	5	7.0 to 7.9	< 7	< 50	1	< 0.1	< 2	5	0.03 to 0.07
8 V 2	8.2	5	7.7 to 8.7	< 7	< 50	1	< 0.1	< 2	6.2	0.03 to 0.08
9 V 1	9.1	5	8.5 to 9.6	< 10	< 50	1	< 0.1	< 2	6.8	0.03 to 0.09
10	10	5	9.4 to 10.6	< 15	< 70	1	< 0.1	< 2	7.5	0.03 to 0.1
11	11	5	10.4 to 11.6	< 20	< 70	1	< 0.1	< 2	8.2	0.03 to 0.11
12	12	5	11.4 to 12.7	< 20	< 90	1	< 0.1	< 2	9.1	0.03 to 0.11
13	13	5	12.4 to 14.1	< 26	< 110	1	< 0.1	< 2	10	0.03 to 0.11
15	15	5	13.8 to 15.6	< 30	< 110	1	< 0.1	< 2	11	0.03 to 0.11
16	16	5	15.3 to 17.1	< 40	< 170	1	< 0.1	< 2	12	0.03 to 0.11
18	18	5	16.8 to 19.1	< 50	< 170	1	< 0.1	< 2	13	0.03 to 0.11
20	20	5	18.8 to 21.2	< 55	< 220	1	< 0.1	< 2	15	0.03 to 0.11
22	22	5	20.8 to 23.3	< 55	< 220	1	< 0.1	< 2	16	0.04 to 0.12
24	24	5	22.8 to 25.6	< 80	< 220	1	< 0.1	< 2	18	0.04 to 0.12
27	27	5	25.1 to 28.9	< 80	< 220	1	< 0.1	< 2	20	0.04 to 0.12
30	30	5	28 to 32	< 80	< 220	1	< 0.1	< 2	22	0.04 to 0.12
33	33	5	31 to 35	< 80	< 220	1	< 0.1	< 2	24	0.04 to 0.12
36	36	5	34 to 38	< 80	< 220	1	< 0.1	< 2	27	0.04 to 0.12
39	39	2.5	37 to 41	< 90	< 500	1	< 0.1	< 5	30	0.04 to 0.12
43	43	2.5	40 to 46	< 90	< 600	0.5	< 0.1	< 5	33	0.04 to 0.12
47	47	2.5	44 to 50	< 110	< 700	0.5	< 0.1	< 5	36	0.04 to 0.12
51	51	2.5	48 to 54	< 125	< 700	0.5	< 0.1	< 10	39	0.04 to 0.12
56	56	2.5	52 to 60	< 135	< 1000	0.5	< 0.1	< 10	43	0.04 to 0.12
62	62	2.5	58 to 66	< 150	< 1000	0.5	< 0.1	< 10	47	0.04 to 0.12
68	68	2.5	64 to 72	< 200	< 1000	0.5	< 0.1	< 10	51	0.04 to 0.12
75	75	2.5	70 to 79	< 250	< 1500	0.5	< 0.1	< 10	56	0.04 to 0.12

¹⁾ $t_p/T \leq 100$ ms, tighter tolerances available on request. ²⁾ at $T_j = 150^\circ\text{C}$

Typical Characteristics ($T_j = 25^\circ\text{C}$ unless otherwise specified)

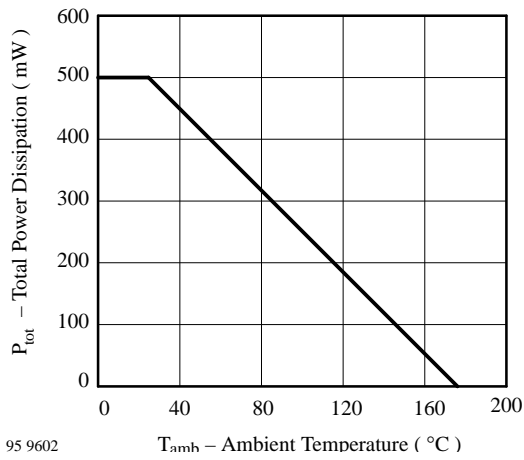

Figure 1 : Total Power Dissipation vs. Ambient Temperature

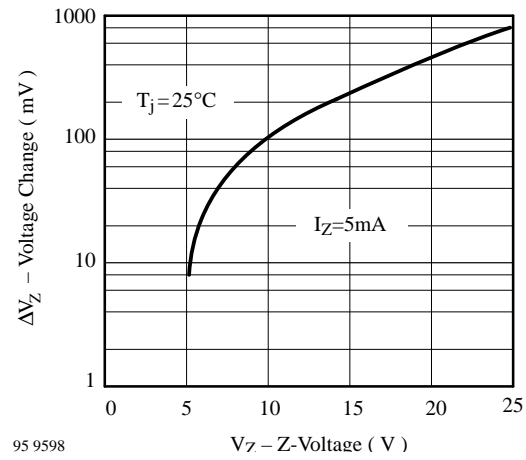

Figure 2 : Typical Change of Working Voltage under Operating Conditions at $T_{\text{amb}}=25^\circ\text{C}$

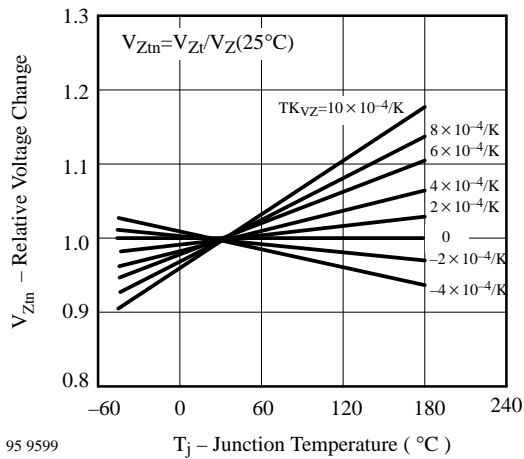

Figure 3 : Typical Change of Working Voltage vs. Junction Temperature

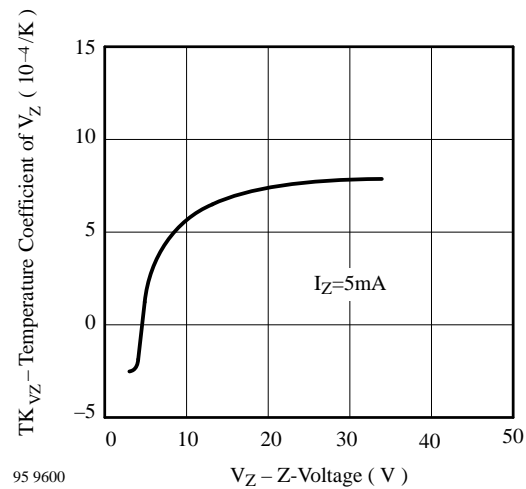

Figure 4 : Temperature Coefficient of V_Z vs. Z -Voltage

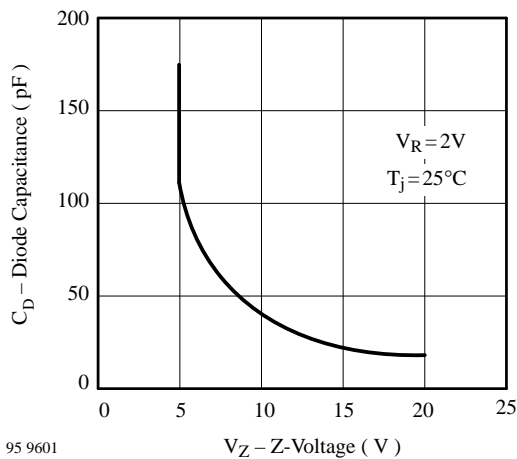

Figure 5 : Diode Capacitance vs. Z -Voltage

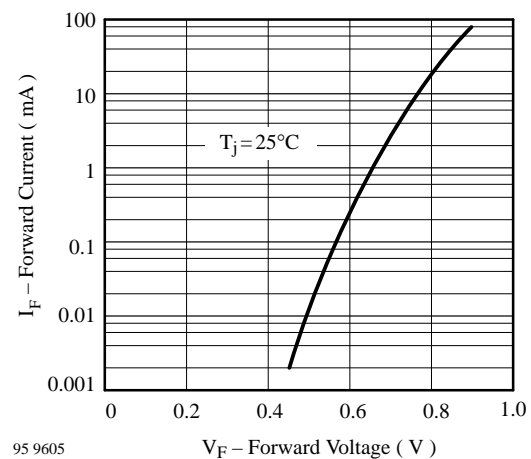

Figure 6 : Forward Current vs. Forward Voltage

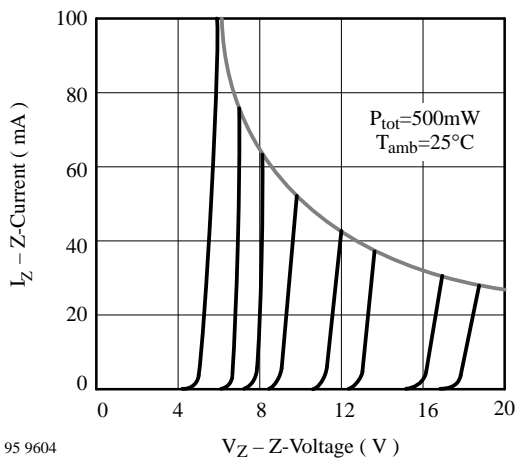

Figure 7 : Z-Current vs. Z-Voltage

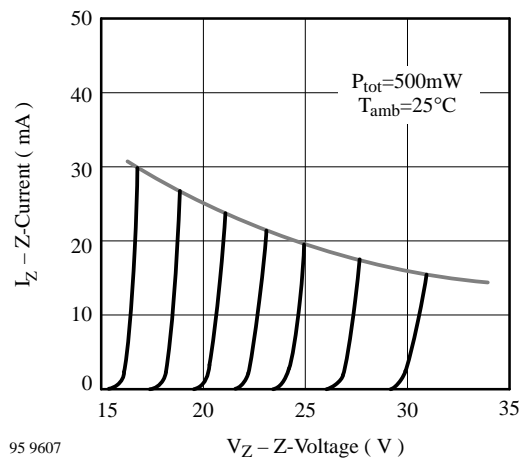

Figure 8 : Z-Current vs. Z-Voltage

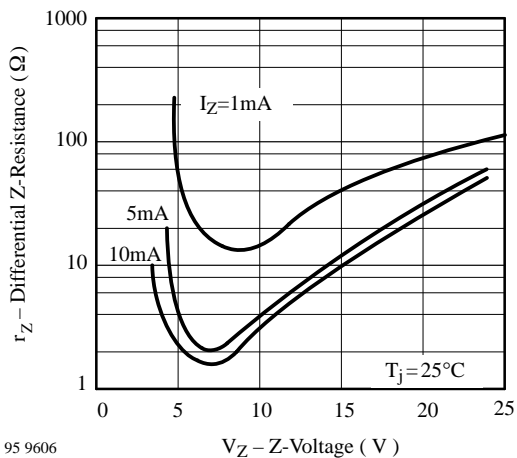

Figure 9 : Differential Z-Resistance vs. Z-Voltage

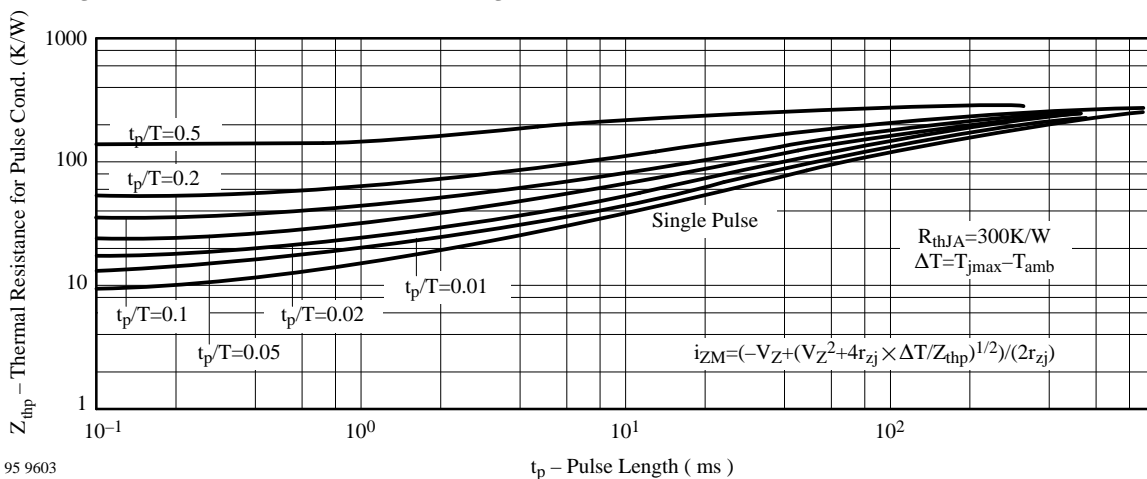
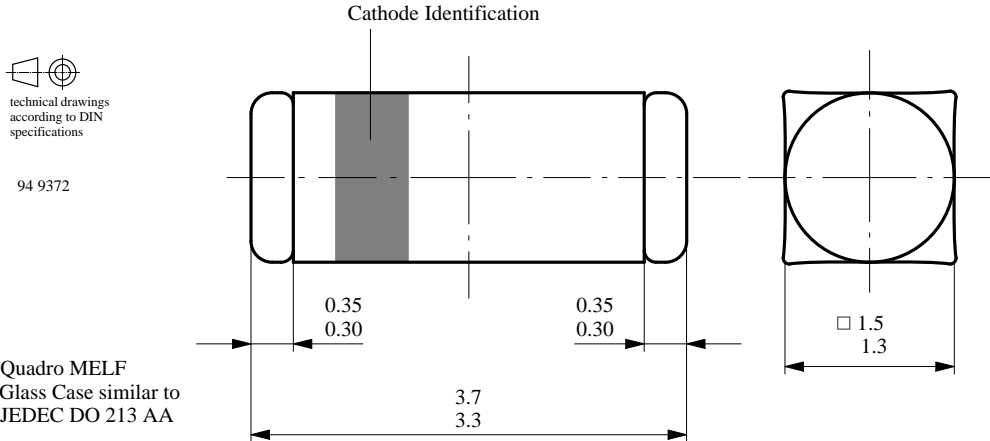

Figure 10 : Thermal Response

Dimensions in mm



OZONE DEPLETING SUBSTANCES POLICY STATEMENT

It is the policy of **TEMIC TELEFUNKEN microelectronic GmbH** to

1. Meet all present and future national and international statutory requirements and
2. Regularly and continuously improve the performance of our products, processes, distribution and operating systems with respect to their impact on the health and safety of our employees and the public, as well as their impact on the environment.

Of particular concern is the control or elimination of releases into the atmosphere of those substances which are known as ozone depleting substances (ODSs).

The Montreal Protocol (1987) and its London Amendments (1990) will soon severely restrict the use of ODSs and forbid their use within the next ten years. Various national and international initiatives are pressing for an earlier ban on these substances.

TEMIC TELEFUNKEN microelectronic GmbH semiconductor division has been able to use its policy of continuous improvements to eliminate the use of any ODSs listed in the following documents.

1. Annex A, B and list of transitional substances of the Montreal Protocol and the London Amendments respectively
2. Class I and II ozone depleting substances in the Clean Air Act Amendments of 1990 by the Environmental Protection Agency (EPA) in the USA and
3. Council Decision 88/540/EEC and 91/690/EEC Annex A, B and C (transitional substances) respectively.

TEMIC can certify that our semiconductors are not manufactured with and do not contain ozone depleting substances.

We reserve the right to make changes to improve technical design without further notice.

Parameters can vary in different applications. All operating parameters must be validated for each customer application by the customer. Should the buyer use TEMIC products for any unintended or unauthorized application, the buyer shall indemnify TEMIC against all claims, costs, damages, and expenses, arising out of, directly or indirectly, any claim of personal damage, injury or death associated with such unintended or unauthorized use.

TEMIC TELEFUNKEN microelectronic GmbH, P.O.B. 3535, D-74025 Heilbronn, Germany
Telephone: 49 (0)7131 67 2831, Fax Number: 49 (0)7131 67 2423