

Features

- Planar Die Construction
- 200mW Power Dissipation
- 2.0V – 51V Nominal Zener Voltage
- 5% Standard Vz Tolerance
- Design for Surface Mount Application
- Plastic Material – UL Recognition Flammability Classification 94V-0

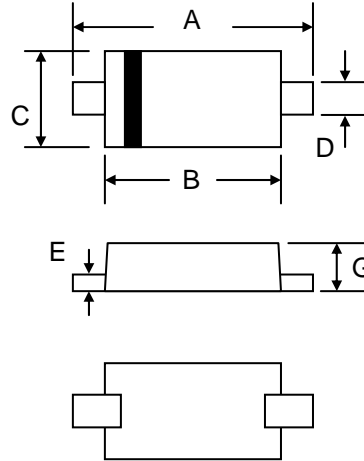

SOD-523		
Dim	Min	Max
A	1.50	1.70
B	1.10	1.30
C	0.70	0.90
D	0.30 Typical	
E	0.10 Typical	
G	0.50	0.70
All Dimensions in mm		

Mechanical Data

- Case: SOD-523, Molded Plastic
- Terminals: Plated Leads Solderable per MIL-STD-202, Method 208
- Polarity: Cathode Band
- Weight: 0.0014 grams (approx.)
- Marking: Device Code
- **Lead Free: For RoHS / Lead Free Version, Add “-LF” Suffix to Part Number, See Page 5**

Maximum Ratings @ $T_A=25^\circ\text{C}$ unless otherwise specified

Characteristic	Symbol	Value	Unit
Power Dissipation at $T_A = 25^\circ\text{C}$ (Note 1)	P_D	200	mW
Forward Voltage @ $I_F = 10\text{mA}$	V_F	0.9	V
Thermal Resistance, Junction to Ambient (Note 1, 2)	R_{JA}	390	$^\circ\text{C}/\text{W}$
Operating and Storage Temperature Range	T_J, T_{STG}	-65 to +150	$^\circ\text{C}$

Note: 1. Mounted on ceramic substrate with 25mm^2 copper pads.
2. Thermal resistance measurement obtained via infrared scan method.

BZX584C2V0 – BZX584C51

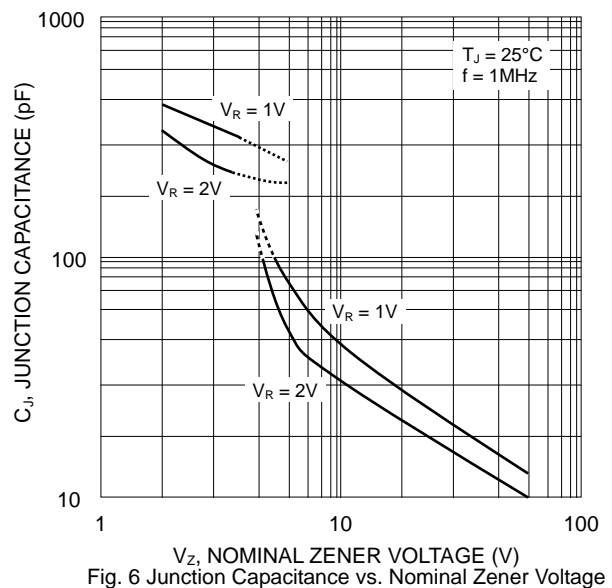
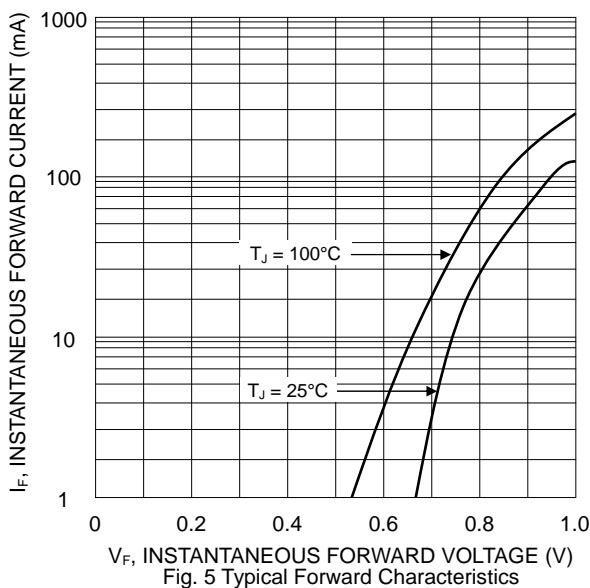
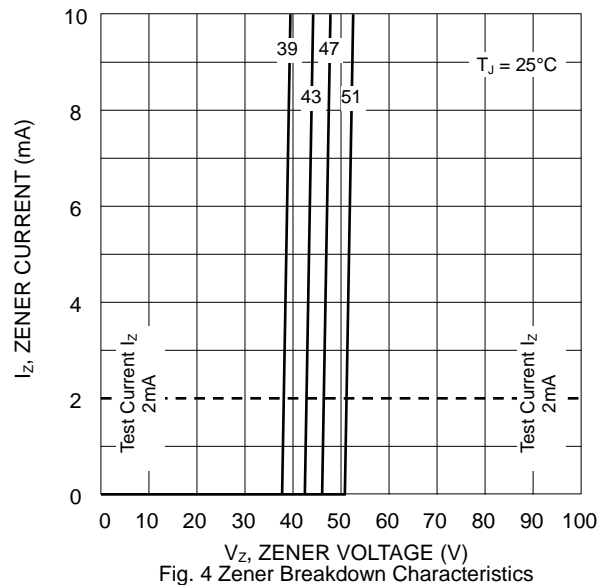
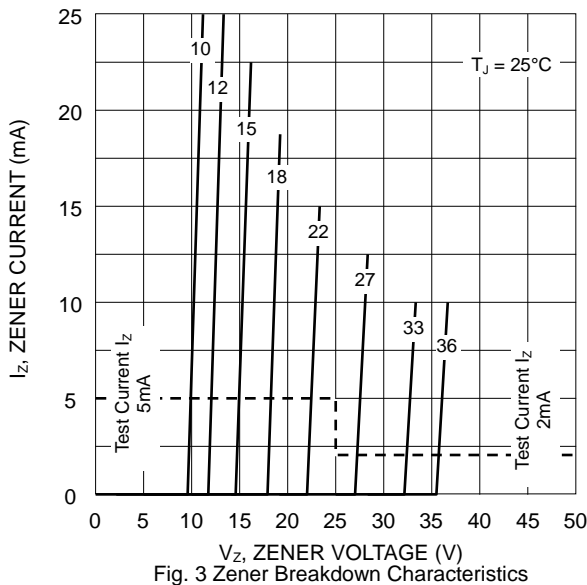
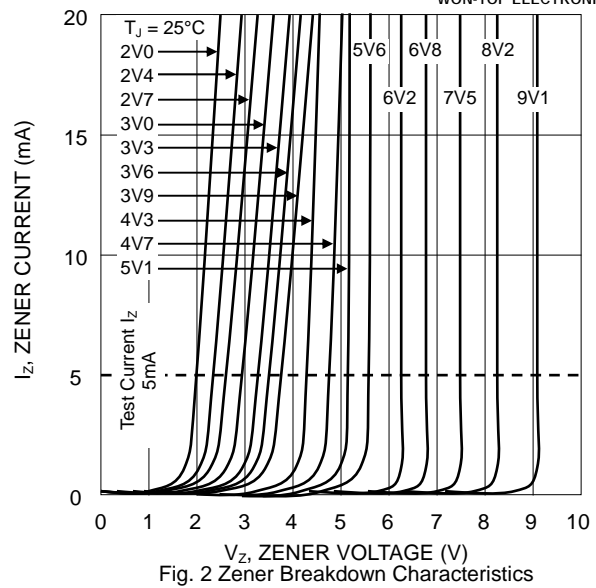
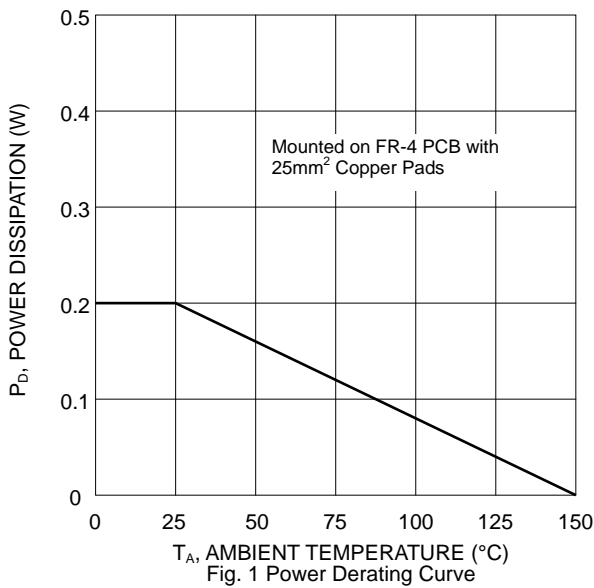

Electrical Characteristics (@T_A=25°C unless otherwise specified) Table 1

Type Number (Note 1)	Device Marking Code (Note 2)		Zener Voltage Range (Note 3)			Maximum Zener Impedance (Note 4)				Max Reverse Leakage Current		Temp. Coefficient of Zener Voltage @ I _{ZT} (mV/K)	
			V _Z @ I _{ZT}			Z _{ZT} @ I _{ZT}		Z _{ZK} @ I _{ZK}		I _R	@ V _R		
	TW	CN	Nom (V)	Min (V)	Max (V)	()	(mA)	()	(mA)	(μA)	(V)	Min	Max
BZX584C2V0	X1	Z10	2.0	1.91	2.09	100	5.0	600	1.0	150	1.0	-3.5	0
BZX584C2V4	W1	Z11	2.4	2.2	2.6	100	5.0	600	1.0	50	1.0	-3.5	0
BZX584C2V7	W2	Z12	2.7	2.5	2.9	100	5.0	600	1.0	20	1.0	-3.5	0
BZX584C3V0	W3	Z13	3.0	2.8	3.2	95	5.0	600	1.0	10	1.0	-3.5	0
BZX584C3V3	W4	Z14	3.3	3.1	3.5	95	5.0	600	1.0	5.0	1.0	-3.5	0
BZX584C3V6	W5	Z15	3.6	3.4	3.8	90	5.0	600	1.0	5.0	1.0	-3.5	0
BZX584C3V9	W6	Z16	3.9	3.7	4.1	90	5.0	600	1.0	3.0	1.0	-3.5	0
BZX584C4V3	W7	Z17	4.3	4.0	4.6	90	5.0	600	1.0	3.0	1.0	-3.5	0
BZX584C4V7	W8	Z1	4.7	4.4	5.0	80	5.0	500	1.0	3.0	2.0	-3.5	0.2
BZX584C5V1	W9	Z2	5.1	4.8	5.4	60	5.0	480	1.0	2.0	2.0	-2.7	1.2
BZX584C5V6	WA	Z3	5.6	5.2	6.0	40	5.0	400	1.0	1.0	2.0	-2.0	2.5
BZX584C6V2	WB	Z4	6.2	5.8	6.6	10	5.0	150	1.0	3.0	4.0	0.4	3.7
BZX584C6V8	WC	Z5	6.8	6.4	7.2	15	5.0	80	1.0	2.0	4.0	1.2	4.5
BZX584C7V5	WD	Z6	7.5	7.0	7.9	15	5.0	80	1.0	1.0	5.0	2.5	5.3
BZX584C8V2	WE	Z7	8.2	7.7	8.7	15	5.0	80	1.0	0.7	5.0	3.2	6.2
BZX584C9V1	WF	Z8	9.1	8.5	9.6	15	5.0	100	1.0	0.5	6.0	3.8	7.0
BZX584C10	WG	Z9	10	9.4	10.6	20	5.0	150	1.0	0.2	7.0	4.5	8.0
BZX584C11	WH	Y1	11	10.4	11.6	20	5.0	150	1.0	0.1	8.0	5.4	9.0
BZX584C12	WI	Y2	12	11.4	12.7	25	5.0	150	1.0	0.1	8.0	6.0	10.0
BZX584C13	WK	Y3	13	12.4	14.1	30	5.0	170	1.0	0.1	8.0	7.0	11.0
BZX584C15	WL	Y4	15	13.8	15.6	30	5.0	200	1.0	0.1	10.5	9.2	13.0
BZX584C16	WM	Y5	16	15.3	17.1	40	5.0	200	1.0	0.1	11.2	10.4	14.0
BZX584C18	WN	Y6	18	16.8	19.1	45	5.0	225	1.0	0.1	12.6	12.4	16.0
BZX584C20	WO	Y7	20	18.8	21.2	55	5.0	225	1.0	0.1	14.0	14.4	18.0
BZX584C22	WP	Y8	22	20.8	23.3	55	5.0	250	1.0	0.1	15.4	16.4	20.0
BZX584C24	WR	Y9	24	22.8	25.6	70	5.0	250	1.0	0.1	16.8	18.4	22.0
BZX584C27	WS	Y10	27	25.1	28.9	80	2.0	300	0.5	0.1	18.9	21.4	25.3
BZX584C30	WT	Y11	30	28.0	32.0	80	2.0	300	0.5	0.1	21.0	24.4	29.4
BZX584C33	WU	Y12	33	31.0	35.0	80	2.0	325	0.5	0.1	23.1	27.4	33.4
BZX584C36	WW	Y13	36	34.0	38.0	90	2.0	350	0.5	0.1	25.2	30.4	37.4
BZX584C39	WX	Y14	39	37.0	41.0	130	2.0	350	0.5	0.1	27.3	33.4	41.2
BZX584C43	WY	Y15	43	40.0	46.0	150	2.0	375	0.5	0.1	30.1	37.6	46.6
BZX584C47	WZ	Y16	47	44.0	50.0	170	2.0	375	0.5	0.1	32.9	42.0	51.8
BZX584C51	XA	Y17	51	48.0	54.0	180	2.0	400	0.5	0.1	35.7	46.6	57.2

- Note: 1. Type numbers listed have standard tolerance on the nominal zener voltage of ±5%.
 2. TW: Marking code for Taiwan plant. CN: Marking code for China plant.
 3. Measured with pulse test current I_Z at ambient temperature 25°C.
 4. f = 1KHz

MARKING INFORMATION

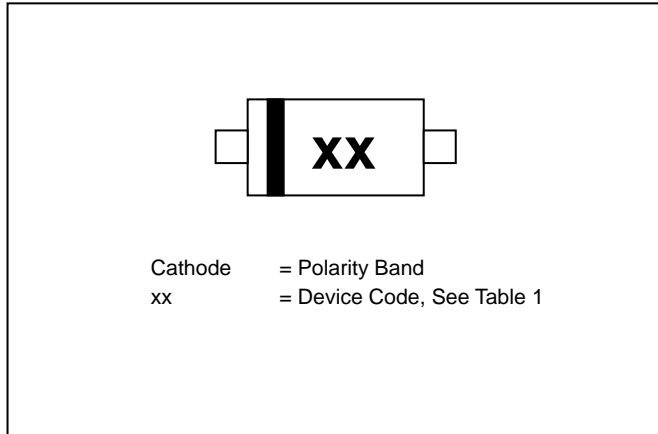

RECOMMENDED FOOTPRINT

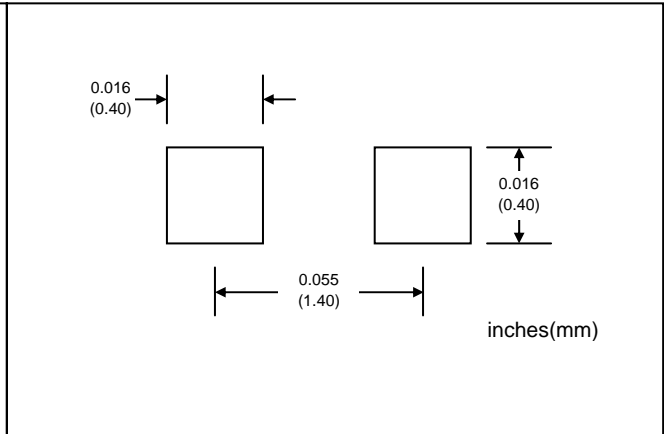

PACKAGING INFORMATION

TAPE & REEL

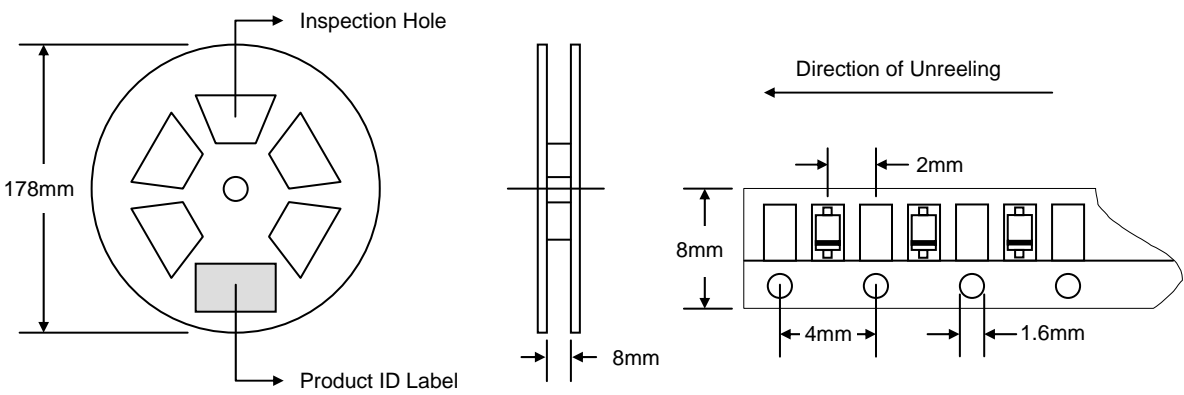

Reel Diameter (mm)	Quantity (PCS)	Inner Box Size L x W x H (mm)	Quantity (PCS)	Carton Size L x W x H (mm)	Quantity (PCS)	Approx. Gross Weight (KG)
178	3,000	187 x 187 x 65	15,000	390 x 240 x 420	150,000	7.0

Note:

1. Anti-static plastic reel, white, water clear or blue color. Inspection hole might be varied in different alignment.
2. Components are packed in accordance with EIA standard 481-1 and 481-2.
3. Components are dispensed in every other cavity of the tape.

ORDERING INFORMATION

Product No.	Package Type	Shipping Quantity
BZX584Cxx-T1	SOD-523	3000/Tape & Reel

1. Shipping quantity given is for minimum packing quantity only. For minimum order quantity, please consult the Sales Department.
2. **To order RoHS / Lead Free version (with Lead Free finish), add "-LF" suffix to part number above. For example, BZX584C2V0-T1-LF.**

WON-TOP ELECTRONICS and  are registered trademarks of Won-Top Electronics Co., Ltd (WTE). WTE has checked all information carefully and believes it to be correct and accurate. However, WTE cannot assume any responsibility for inaccuracies. Furthermore, this information does not give the purchaser of semiconductor devices any license under patent rights to manufacturer. WTE reserves the right to change any or all information herein without further notice.

WARNING: DO NOT USE IN LIFE SUPPORT EQUIPMENT. WTE power semiconductor products are not authorized for use as critical components in life support devices or systems without the express written approval.

Won-Top Electronics Co., Ltd.
No. 44 Yu Kang North 3rd Road,
Chine Chen Dist., Kaohsiung 806, Taiwan
Phone: 886-7-822-5408 or 886-7-822-5410
Fax: 886-7-822-5417
Email: sales@wontop.com
Internet: <http://www.wontop.com>

We power your everyday.