

Features

- Dual Zener Diodes in Common Cathode
- 350mW Power Dissipation
- 2.4V – 75V Nominal Zener Voltage
- 5% Standard Vz Tolerance
- Designed for Surface Mount Application
- Plastic Material – UL Recognition Flammability Classification 94V-0

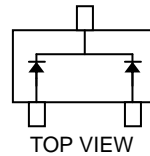
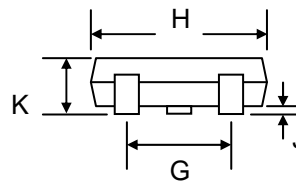
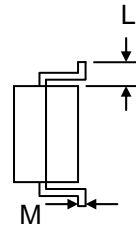
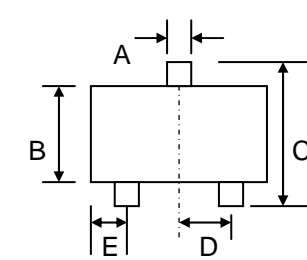

SOT-23		
Dim	Min	Max
A	0.37	0.51
B	1.19	1.40
C	2.10	2.50
D	0.89	1.05
E	0.45	0.61
G	1.78	2.05
H	2.65	3.05
J	0.013	0.15
K	0.89	1.10
L	0.45	0.61
M	0.076	0.178
All Dimensions in mm		

Mechanical Data

- Case: SOT-23, Molded Plastic
- Terminals: Plated Leads Solderable per MIL-STD-202, Method 208
- Polarity: See Diagram
- Weight: 0.008 grams (approx.)
- Mounting Position: Any
- Marking: Device Code
- **Lead Free: For RoHS / Lead Free Version, Add “-LF” Suffix to Part Number, See Page 5**

Maximum Ratings @T_A=25°C unless otherwise specified

Characteristic	Symbol	Value	Unit
Peak Pulse Power Dissipation at T _A = 25°C (Note 1)	P _D	350	mW
Forward Voltage @ I _F = 10mA	V _F	0.9	V
Thermal Resistance Junction to Ambient (Note 1, 2)	R _{JA}	417	°C/W
Operating and Storage Temperature Range	T _J , T _{STG}	-65 to +150	°C

Note: 1. Mounted on FR-4 PCB with minimum recommended pad layout.
 2. Thermal resistance measurement obtained via infrared scan method.

BZX84C2V4CC – BZX84C75CC

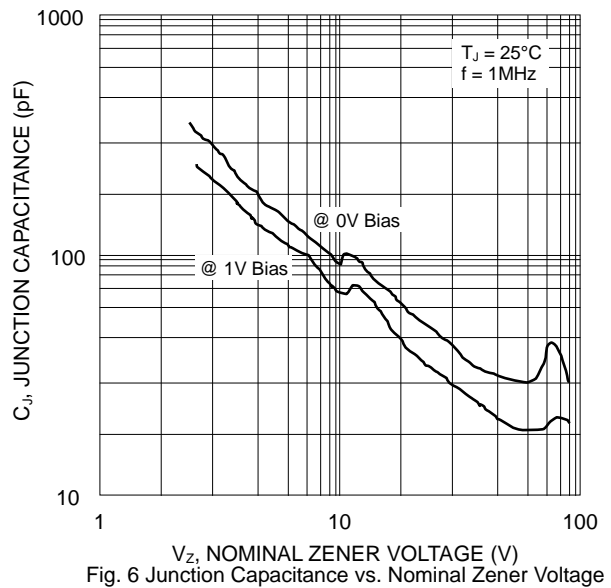
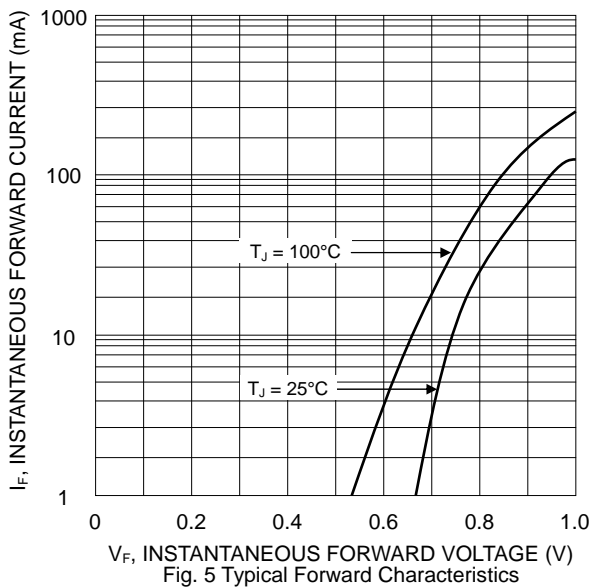
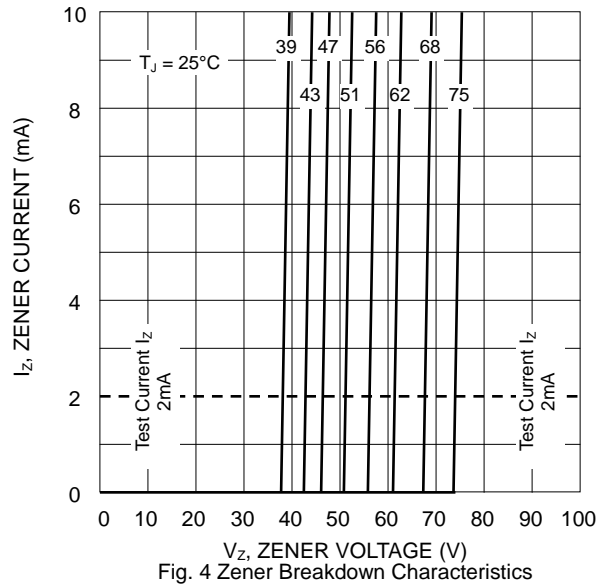
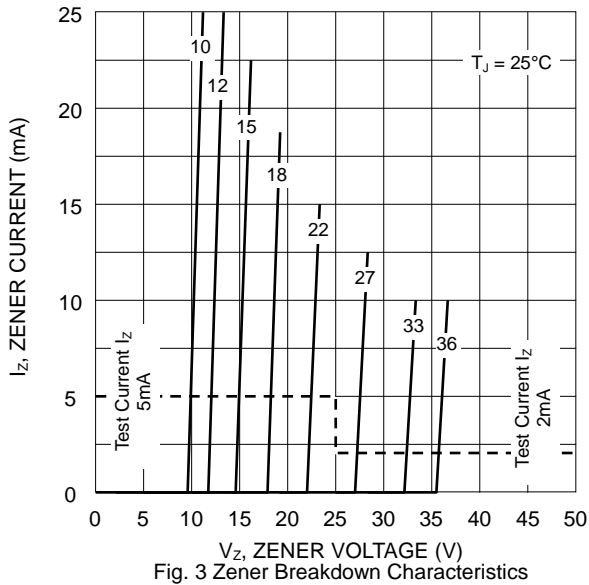
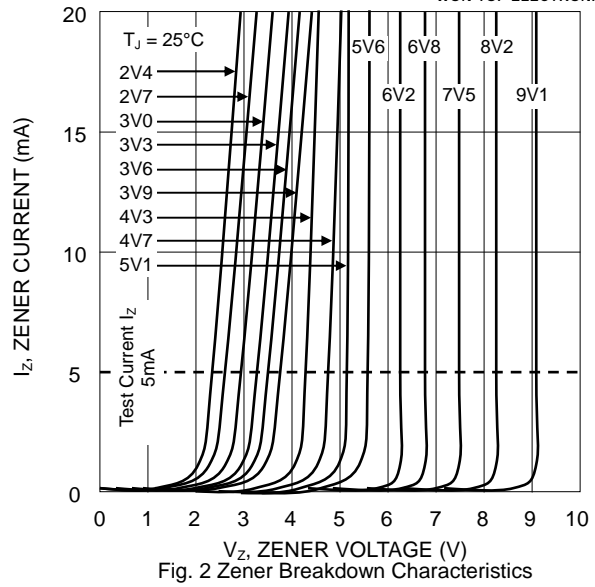
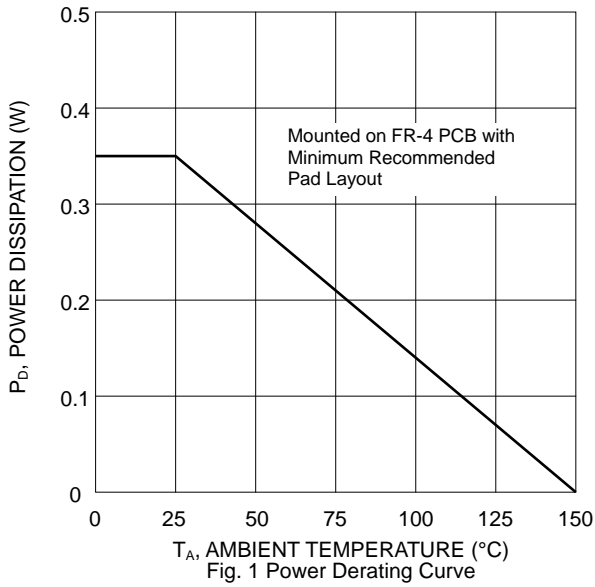

Electrical Characteristics (@T_A=25°C unless otherwise specified) Table 1

Type Number (Note 1)	Device Marking Code	Zener Voltage Range (Note 2)			Maximum Zener Impedance (Note 3)				Max Reverse Leakage Current		Temp. Coefficient of Zener Voltage @ I _{ZT} (mV/K)	
		V _Z @ I _{ZT}			Z _{ZT} @ I _{ZT}		Z _{ZK} @ I _{ZK}		I _R	@ V _R	Min	Max
		Nom (V)	Min (V)	Max (V)	()	(mA)	()	(mA)	(μA)	(V)		
BZX84C2V4CC	JH	2.4	2.2	2.6	100	5.0	600	1.0	50	1.0	-3.5	0
BZX84C2V7CC	JJ	2.7	2.5	2.9	100	5.0	600	1.0	20	1.0	-3.5	0
BZX84C3V0CC	JK	3.0	2.8	3.2	95	5.0	600	1.0	10	1.0	-3.5	0
BZX84C3V3CC	JM	3.3	3.1	3.5	95	5.0	600	1.0	5.0	1.0	-3.5	0
BZX84C3V6CC	JN	3.6	3.4	3.8	90	5.0	600	1.0	5.0	1.0	-3.5	0
BZX84C3V9CC	JP	3.9	3.7	4.1	90	5.0	600	1.0	3.0	1.0	-3.5	0
BZX84C4V3CC	JR	4.3	4.0	4.6	90	5.0	600	1.0	3.0	1.0	-3.5	0
BZX84C4V7CC	JX	4.7	4.4	5.0	80	5.0	500	1.0	3.0	2.0	-3.5	0.2
BZX84C5V1CC	JY	5.1	4.8	5.4	60	5.0	480	1.0	2.0	2.0	-2.7	1.2
BZX84C5V6CC	JZ	5.6	5.2	6.0	40	5.0	400	1.0	1.0	2.0	-2.0	2.5
BZX84C6V2CC	KA	6.2	5.8	6.6	10	5.0	150	1.0	3.0	4.0	0.4	3.7
BZX84C6V8CC	KB	6.8	6.4	7.2	15	5.0	80	1.0	2.0	4.0	1.2	4.5
BZX84C7V5CC	KC	7.5	7.0	7.9	15	5.0	80	1.0	1.0	5.0	2.5	5.3
BZX84C8V2CC	KD	8.2	7.7	8.7	15	5.0	80	1.0	0.7	5.0	3.2	6.2
BZX84C9V1CC	KE	9.1	8.5	9.6	15	5.0	100	1.0	0.5	6.0	3.8	7.0
BZX84C10CC	KF	10	9.4	10.6	20	5.0	150	1.0	0.2	7.0	4.5	8.0
BZX84C11CC	KH	11	10.4	11.6	20	5.0	150	1.0	0.1	8.0	5.4	9.0
BZX84C12CC	KJ	12	11.4	12.7	25	5.0	150	1.0	0.1	8.0	6.0	10.0
BZX84C13CC	KK	13	12.4	14.1	30	5.0	170	1.0	0.1	8.0	7.0	11.0
BZX84C15CC	KM	15	13.8	15.6	30	5.0	200	1.0	0.05	10.5	9.2	13.0
BZX84C16CC	KN	16	15.3	17.1	40	5.0	200	1.0	0.05	11.2	10.4	14.0
BZX84C18CC	KP	18	16.8	19.1	45	5.0	225	1.0	0.05	12.6	12.4	16.0
BZX84C20CC	KR	20	18.8	21.2	55	5.0	225	1.0	0.05	14.0	14.4	18.0
BZX84C22CC	KX	22	20.8	23.3	55	5.0	250	1.0	0.05	15.4	16.4	20.0
BZX84C24CC	KY	24	22.8	25.6	70	5.0	250	1.0	0.05	16.8	18.4	22.0
BZX84C27CC	KZ	27	25.1	28.9	80	2.0	300	0.5	0.05	18.9	21.4	25.3
BZX84C30CC	MA	30	28.0	32.0	80	2.0	300	0.5	0.05	21.0	24.4	29.4
BZX84C33CC	MB	33	31.0	35.0	80	2.0	325	0.5	0.05	23.1	27.4	33.4
BZX84C36CC	MC	36	34.0	38.0	90	2.0	350	0.5	0.05	25.2	30.4	37.4
BZX84C39CC	MD	39	37.0	41.0	130	2.0	350	0.5	0.05	27.3	33.4	41.2
BZX84C43CC	ME	43	40.0	46.0	150	2.0	375	0.5	0.05	30.1	37.6	46.6
BZX84C47CC	MF	47	44.0	50.0	170	2.0	375	0.5	0.05	32.9	42.0	51.8
BZX84C51CC	MH	51	48.0	54.0	180	2.0	400	0.5	0.05	35.7	46.6	57.2
BZX84C56CC	MJ	56	52.0	60.0	200	2.0	425	0.5	0.05	39.2	52.2	63.8
BZX84C62CC	MK	62	58.0	66.0	215	2.0	450	0.5	0.05	43.4	58.8	71.6
BZX84C68CC	MM	68	64.0	72.0	240	2.0	475	0.5	0.05	47.6	65.6	79.8
BZX84C75CC	MN	75	70.0	79.0	255	2.0	500	0.5	0.05	52.5	73.4	88.6

Note: 1. Type numbers listed have standard tolerance on the nominal zener voltage of ±5%.
 2. Measured with pulse test current I_Z at ambient temperature 25°C.
 3. f = 1KHz

MARKING INFORMATION

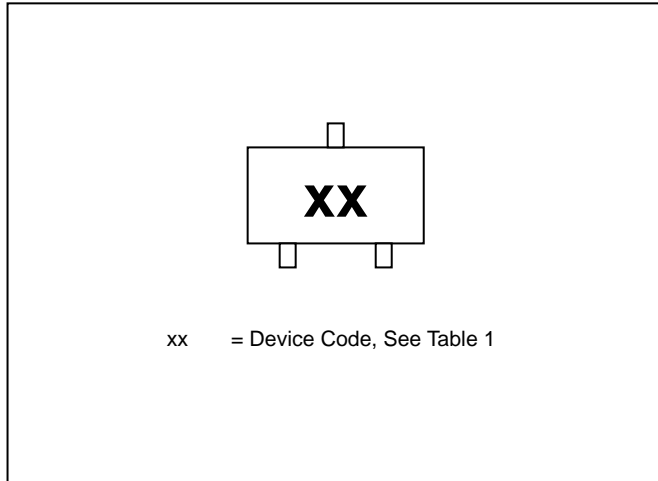

RECOMMENDED FOOTPRINT

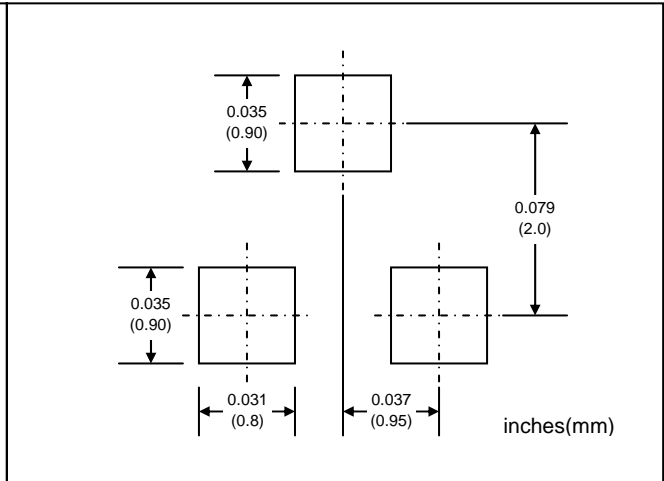

PACKAGING INFORMATION

TAPE & REEL

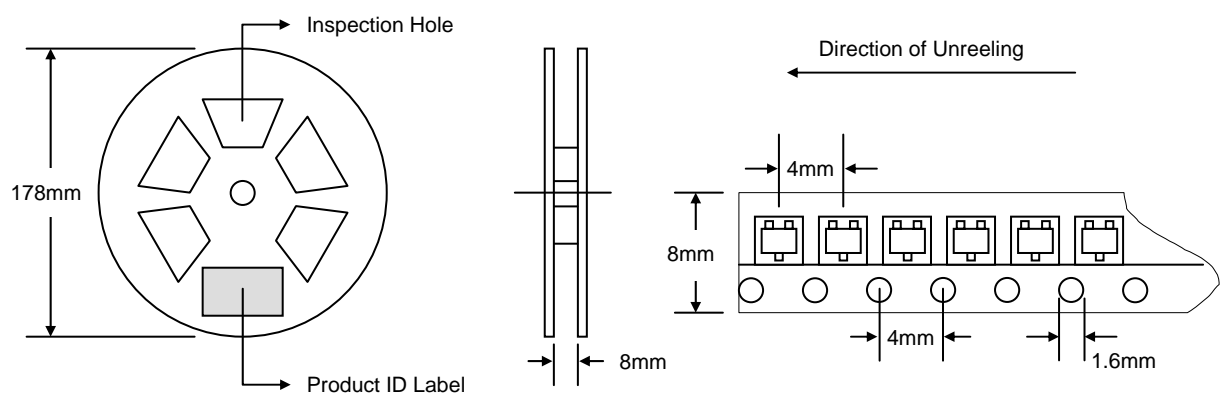

Reel Diameter (mm)	Quantity (PCS)	Inner Box Size L x W x H (mm)	Quantity (PCS)	Carton Size L x W x H (mm)	Quantity (PCS)	Approx. Gross Weight (KG)
178	3,000	187 x 187 x 65	15,000	390 x 240 x 420	150,000	10.0

Note: 1. Anti-static plastic reel, white, water clear or blue color. Inspection hole might be varied in different alignment.
2. Components are packed in accordance with EIA standard 481-1 and 481-2.

ORDERING INFORMATION

Product No.	Package Type	Shipping Quantity
BZX84CxxCC-T1	SOT-23	3000/Tape & Reel

1. Shipping quantity given is for minimum packing quantity only. For minimum order quantity, please consult the Sales Department.
2. **To order RoHS / Lead Free version (with Lead Free finish), add “-LF” suffix to part number above. For example, BZX84C2V4CC-T1-LF.**

WON-TOP ELECTRONICS and  are registered trademarks of Won-Top Electronics Co., Ltd (WTE). WTE has checked all information carefully and believes it to be correct and accurate. However, WTE cannot assume any responsibility for inaccuracies. Furthermore, this information does not give the purchaser of semiconductor devices any license under patent rights to manufacturer. WTE reserves the right to change any or all information herein without further notice.

WARNING: DO NOT USE IN LIFE SUPPORT EQUIPMENT. WTE power semiconductor products are not authorized for use as critical components in life support devices or systems without the express written approval.

Won-Top Electronics Co., Ltd.
No. 44 Yu Kang North 3rd Road,
Chine Chen Dist., Kaohsiung 806, Taiwan
Phone: 886-7-822-5408 or 886-7-822-5410
Fax: 886-7-822-5417
Email: sales@wontop.com
Internet: <http://www.wontop.com>

We power your everyday.